

YASKAWA

AC SERVO DRIVES Σ -7 SERIES

Rotary Servomotors



e-motional
solution

上正科技有限公司

購買、維修 此手冊零組件

電話： 037-466333

Email: service@repairtw.com

Line id: @zzzz

www.repairtw.com



Certified for
ISO9001 and
ISO14001



JQA-0422



JQA-EM0202



MECHATROLINK



CONTENTS

Rotary Servomotors	
SGMMV (Low Inertia, Ultra-small Size)	4
SGM7J (Medium Inertia, High-speed)	14
SGM7A (Low Inertia, High-speed)	38
SGM7P (Medium Inertia, Flat Type)	74
SGM7G (Medium Inertia, Large Torque)	94

Rotary Servomotors

■ Features



SGMMV (Low Inertia, Ultra Small Size)..... 4

- Contributes to machine downsizing (flange size: 25 mm × 25 mm).
- Ultra small capacity: 10 W to 30 W and maximum motor speed: 6,000 min⁻¹
- Mounted absolute serial encoder: 17 bits. Can be used as an incremental encoder.



SGM7J (Medium Inertia, High Speed)..... 14

- Instantaneous peak torque: 350% of rated torque.
- Protective structure: IP67
- Mounted high-resolution serial encoder: 24 bits. Batteryless absolute encoder also provided.
- Full lineup (50 W to 750 W, with holding brake, with gears, and with oil seal).
- Cables can be installed in both load side and non-load side.



SGM7A (Low Inertia, High Speed) 38

- Instantaneous peak torque: 350% of rated torque (for motors of less than 1 kW).
- Protective structure: IP67 (IP22 for 7.0 kW motor)
- Mounted high-resolution serial encoder: 24 bits. Batteryless absolute encoder also provided.
- Full lineup (50 W to 7.0 kW, with holding brake, with gears, and with oil seal).
- Cables can be installed in both load side and non-load side (for motors of less than 1 kW).



SGM7P (Medium Inertia, Flat Type) 74

- Flat type with short depth.
- Mounted high-resolution serial encoder: 24 bits. Batteryless absolute encoder also provided.
- Full lineup (100 W to 1.5 kW, with holding brake, with gears, and with oil seal).



SGM7G (Medium Inertia, Large Torque) 94

- Protective structure: IP67
- Mounted high-resolution serial encoder: 24 bits. Batteryless absolute encoder also provided.
- Full lineup (300 W to 15 kW, with holding brake, and with oil seal).

SGMMV

SGM7J

SGM7A

SGM7P

SGM7G

精誠維修此系伺服組件
電話：037-466333
www.epairtw.com

SGMMV

Model Designations

SGMMV - A1 A 2 A 2 1

1st+2nd digits 3rd digit 4th digit 5th digit 6th digit 7th digit

Σ-V mini Series Servomotors: SGMMV

1st+2nd digits Rated Output

Code	Specification
A1	10 W
A2	20 W
A3	30 W

3rd digit Power Supply Voltage

Code	Specification
A	200 VAC

4th digit Serial Encoder

Code	Specification
2	17-bit absolute

5th digit Design Revision Order

A

6th digit Shaft End

Code	Specification
2	Straight (standard)
A	Straight with flat seats (optional)

7th digit Options

Code	Specification
1	Without options
C	With holding brake (24 VDC)

上正科技有限公司

購買、維修 此手冊零組件

電話： 037-466333

Email: service@repairtw.com

Line id: @zzzz

www.repairtw.com

Specifications and Ratings

Specifications

Voltage		200 V		
Model SGMMV-		A1A	A2A	A3A
Time Rating		Continuous		
Thermal Class		B		
Insulation Resistance		500 VDC, 10 MΩ min.		
Withstand Voltage		1,500 VAC for 1 minute		
Excitation		Permanent magnet		
Mounting		Flange-mounted		
Drive Method		Direct drive		
Rotation Direction		Counterclockwise (CCW) for forward reference when viewed from the load side		
Vibration Class* ¹		V15		
Environmental Conditions	Surrounding Air Temperature	0°C to 40°C		
	Surrounding Air Humidity	20% to 80% relative humidity (with no condensation)		
	Installation Site	<ul style="list-style-type: none"> • Must be indoors and free of corrosive and explosive gases. • Must be well-ventilated and free of dust and moisture. • Must facilitate inspection and cleaning. • Must have an altitude of 1,000 m or less. • Must be free of strong magnetic fields. 		
	Storage Environment	Store the Servomotor in the following environment if you store it with the power cable disconnected. Storage Temperature: -20°C to 60°C (with no freezing) Storage Humidity: 20% to 80% relative humidity (with no condensation)		
Shock Resistance* ²	Impact Acceleration Rate at Flange	490 m/s ²		
	Number of Impacts	2 times		
Vibration Resistance* ²	Vibration Acceleration Rate at Flange	49 m/s ²		
Applicable SERVOPACKs	SGD7S-	R90A, R90F		1R6A, 2R1F
	SGD7W-SGD7C-	1R6A* ³ , 2R8A* ³		1R6A, 2R8A* ³

*1. A vibration class of V15 indicates a vibration amplitude of 15 μm maximum on the Servomotor without a load at the rated motor speed.

*2. The given values are for when the Servomotor shaft is mounted horizontally and shock or vibration is applied in the directions shown in the following figures.

The strength of the vibration that the Servomotor can withstand depends on the application. Always check the vibration acceleration rate that is applied to the Servomotor with the actual equipment.

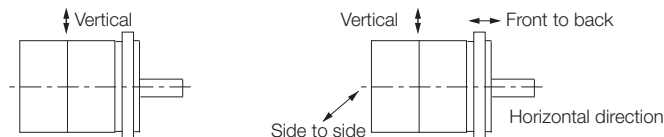

Shock Applied to the Servomotor

Vibration Applied to the Servomotor

*3. If you use a Servomotor together with a Σ-7W or Σ-7C SERVOPACK, the control gain may not increase as much as with a Σ-7S SERVOPACK and other performances may be lower than those achieved with a Σ-7S SERVOPACK.

Servomotor Ratings

Voltage		200 V			
Model SGMMV-		A1A	A2A	A3A	
Rated Output* ¹	W	10	20	30	
Rated Torque* ^{1, *2}	N·m	0.0318	0.0637	0.0955	
Instantaneous Maximum Torque* ¹	N·m	0.0955	0.191	0.286	
Rated Current* ¹	Arms	0.70	0.66	0.98	
Instantaneous Maximum Current* ¹	Arms	2.0	1.9	2.9	
Rated Motor Speed* ¹	min ⁻¹	3000			
Maximum Motor Speed* ¹	min ⁻¹	6000			
Torque Constant	N·m/Arms	0.0516	0.107	0.107	
Motor Moment of Inertia	×10 ⁻⁷ kg·m ²	2.72 (4.07)	4.66 (6.02)	6.68 (8.04)	
Rated Power Rate* ¹	kW/s	3.72	8.71	13.7	
Rated Angular Acceleration Rate* ¹	rad/s ²	117000	137000	143000	
Heat Sink Size (Aluminum)* ³	mm	150×150×3		250×250×6	
Protective Structure* ⁴	Totally enclosed, self-cooled, IP55 (except for shaft opening)				
Holding Brake Specifications* ⁵	Rated Voltage	V	24 VDC ^{+10%} ₀		
	Capacity	W	2.0	2.6	
	Holding Torque	N·m	0.0318	0.0637	0.0955
	Coil Resistance	Ω (at 20°C)	320	221.5	
	Rated Current	A (at 20°C)	0.075	0.108	
	Time Required to Release Brake	ms	40		
	Time Required to Brake	ms	100		
Allowable Load Moment of Inertia (Motor Moment of Inertia Ratio)* ⁶			30 times		
	With External Regenerative Resistor		30 times		
Allowable Shaft Loads* ⁷	LF	mm	16		
	Allowable Radial Load	N	34	44	
	Allowable Thrust Load	N	14.5		

Note: The values in parentheses are for Servomotors with Holding Brakes.

*1. These values are for operation in combination with a SERVOPACK when the temperature of the armature winding is 100°C. These are typical values.

*2. The rated torques are the continuous allowable torque values with an aluminum or steel heat sink of the dimensions given in the table.

*3. Refer to the following section for the relation between the heat sinks and derating rate.

 **Servomotor Heat Dissipation Conditions (page 9)**

*4. This does not apply to the shaft opening. Protective structure specifications apply only when the special cable is used.

*5. Observe the following precautions if you use a Servomotor with a Holding Brake.

- The holding brake cannot be used to stop the Servomotor.
- The time required to release the brake and the time required to brake depend on which discharge circuit is used. Confirm that the operation delay time is appropriate for the actual equipment.
- The 24-VDC power supply is not provided by Yaskawa.

*6. The motor moment of inertia scaling factor is the value for a standard Servomotor without a Holding Brake.

*7. Design the mechanical system so that the thrust and radial loads applied to the Servomotor shaft end during operation do not exceed the values given in the table.

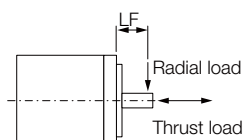

Torque-Motor Speed Characteristics

- A** : Continuous duty zone
- B** : Intermittent duty zone*

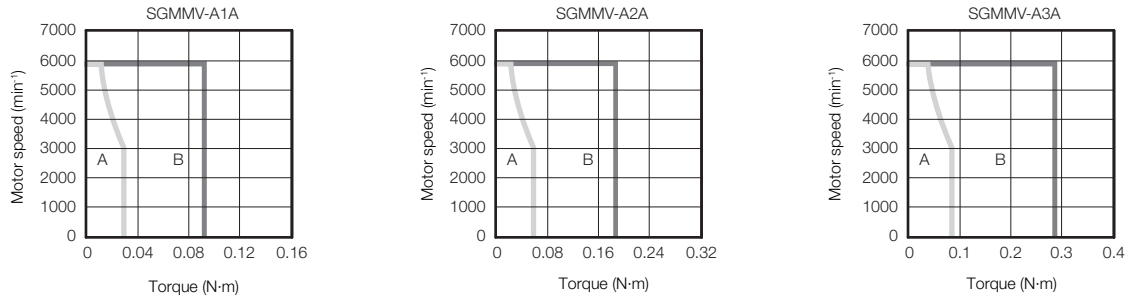

* The characteristics are the same for three-phase 200 V, single-phase 200 V, and single-phase 100 V input.

- Note: 1. These values (typical values) are for operation in combination with a SERVOPACK when the temperature of the armature winding is 100°C.
2. The characteristics in the intermittent duty zone depend on the power supply voltage.
 3. If the effective torque is within the allowable range for the rated torque, the Servomotor can be used within the intermittent duty zone.
 4. If you use a Servomotor Main Circuit Cable that exceeds 20 m, the intermittent duty zone in the torque-motor speed characteristics will become smaller because the voltage drop increases.

Servomotor Overload Protection Characteristics

The overload detection level is set for hot start conditions with a Servomotor surrounding air temperature of 40°C.

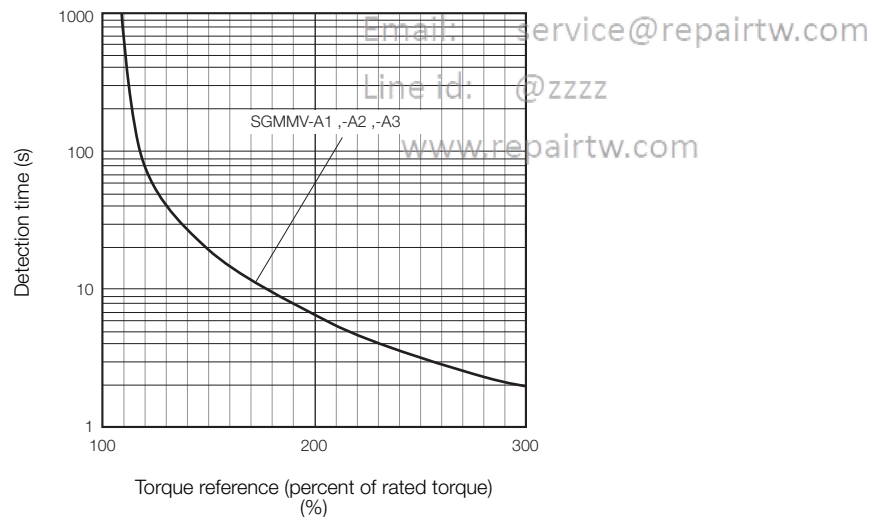

Note: The above overload protection characteristics do not mean that you can perform continuous duty operation with an output of 100% or higher. Use the Servomotor so that the effective torque remains within the continuous duty zone given in *Torque-Motor Speed Characteristics* (page 7).

Allowable Load Moment of Inertia

The allowable load moments of inertia (motor moment of inertia ratios) for the Servomotors are given in the *Servomotor Ratings* (page 6). The values are determined by the regenerative energy processing capacity of the SERVOPACK and are also affected by the drive conditions of the Servomotor. Perform the required Steps for each of the following cases.

Use the SigmaSize+ AC Servo Drive Capacity Selection Program to check the driving conditions. Contact your Yaskawa representative for information on this program.

◆ Exceeding the Allowable Load Moment of Inertia

Use one of the following measures to adjust the load moment of inertia to within the allowable value.

- Reduce the torque limit.
- Reduce the deceleration rate.
- Reduce the maximum motor speed.

If the above steps is not possible, install an external regenerative resistor.

Information An Overvoltage Alarm (A.400) is likely to occur during deceleration if the load moment of inertia exceeds the allowable load moment of inertia. SERVOPACKs with a built-in regenerative resistor may generate a Regenerative Overload Alarm (A.320). Refer to *Built-In Regenerative Resistor* (page 472) for the regenerative power (W) that can be processed by the SERVOPACKs.
Install an External Regenerative Resistor when the built-in regenerative resistor cannot process all of the regenerative power.

◆ SERVOPACKs without Built-in Regenerative Resistors

The following graph shows the allowable load moment of inertia scaling factor of the motor speed (reference values for deceleration operation at or above the rated torque). Application is possible without an external regenerative resistor within the allowable value. However, an External Regenerative Resistor is required in the shaded areas of the graphs.

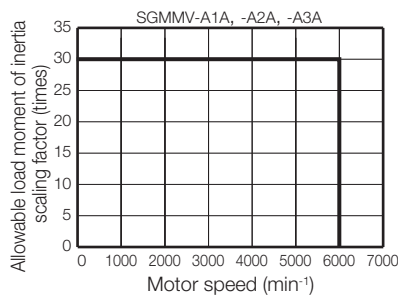

Note: Applicable SERVOPACK models: SGD7S-R90A, -1R6A, -R90F, and -2R1F

◆ When an External Regenerative Resistor Is Required

Install the External Regenerative Resistor. Refer to the following section for the recommended products.

External Regenerative Resistors (page 472)

Derating Rates

◆ Servomotor Heat Dissipation Conditions

The Servomotor ratings are the continuous allowable values when a heat sink is installed on the Servomotor. If the Servomotor is mounted on a small device component, the Servomotor temperature may rise considerably because the surface for heat dissipation becomes smaller. Refer to the following graphs for the relation between the heat sink size and derating rate.

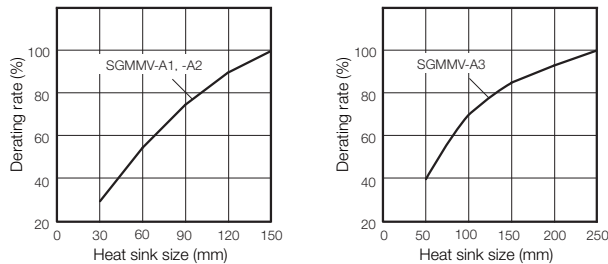

Important

The actual temperature rise depends on how the heat sink (i.e., the Servomotor mounting section) is attached to the installation surface, what material is used for the Servomotor mounting section, and the motor speed. Always check the Servomotor temperature with the actual equipment.

Information

When using Servomotors with derating, change the detection timing of overload warning and overload alarm based on the overload detection level of the motor given in *Servomotor Overload Protection Characteristics* (page 7).

Note: The derating rates are applicable only when the average motor speed is less than or equal to the rated motor speed. If the average motor speed exceeds the rated motor speed, consult with your Yaskawa representative.

Line id: @zzzz

www.repairtw.com

External Dimensions

Servomotors without Holding Brakes

◆ SGMMV-A1, -A2 and -A3

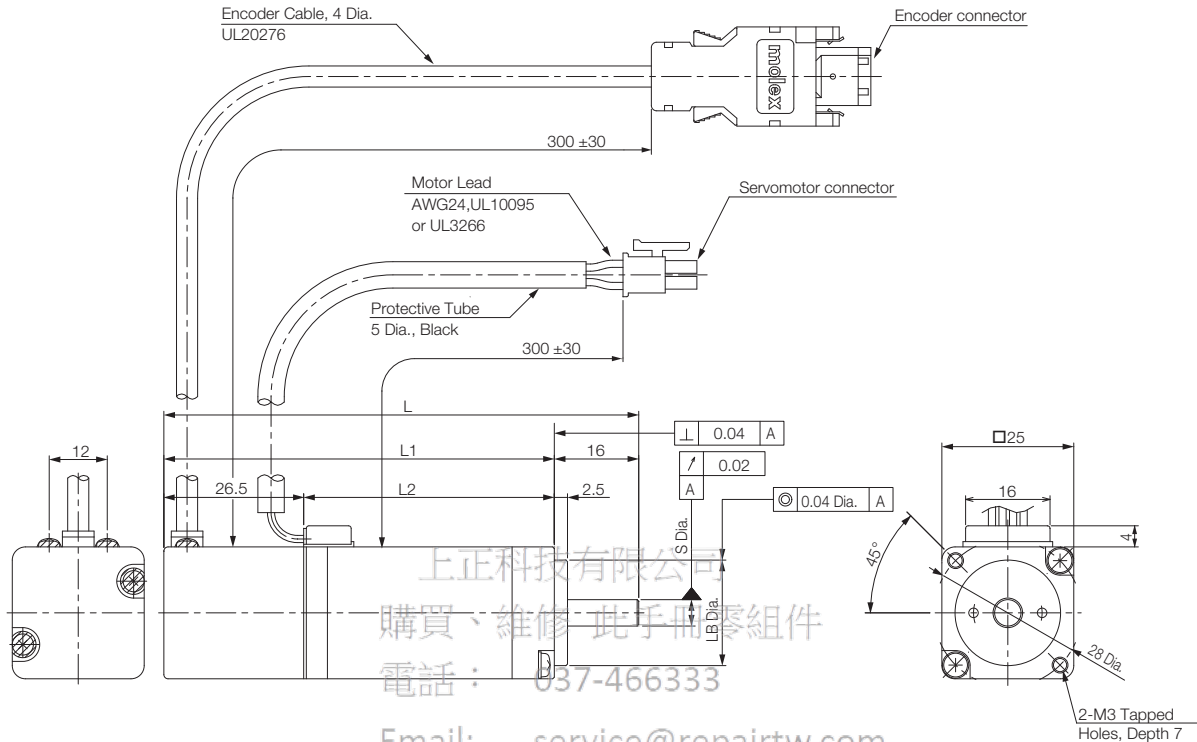

Model SGMMV-	L	L1	L2	Flange Dimensions		Approx. Mass [kg]
				S	LB	
A1A2A□1	70	54	27.5	5 ⁰ _{-0.008}	20 ⁰ _{-0.021}	0.13
A2A2A□1	80	64	37.5	5 ⁰ _{-0.008}	20 ⁰ _{-0.021}	0.17
A3A2A□1	90	74	47.5	5 ⁰ _{-0.008}	20 ⁰ _{-0.021}	0.21

■ Shaft End Specification

- Straight with Flat Seats

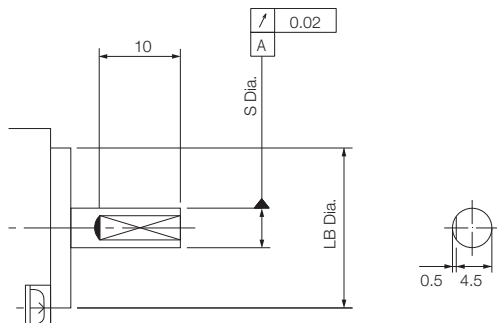

■ Connector Specifications

• Encoder Connector

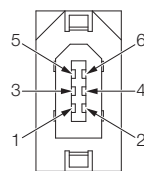

1	PG5V	Red
2	PG0V	Black
3*	BAT	Orange
4*	BAT0	Orange/white
5	PS	Light blue
6	/PS	Light blue/white
Connector case	FG (frame ground)	Shield

* A battery is required only for an absolute encoder.

Model: 55102-0600

Manufacturer: Molex Japan LLC

Mating connector: 54280-0609

• Servomotor Connector

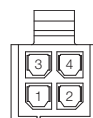

1	Phase U
2	Phase V
3	Phase W
4	FG (frame ground)

Receptacle: 43025-0400

Manufacturer: Molex Japan LLC

Servomotors with Holding Brakes

◆ SGMMV-A1, -A2 and -A3

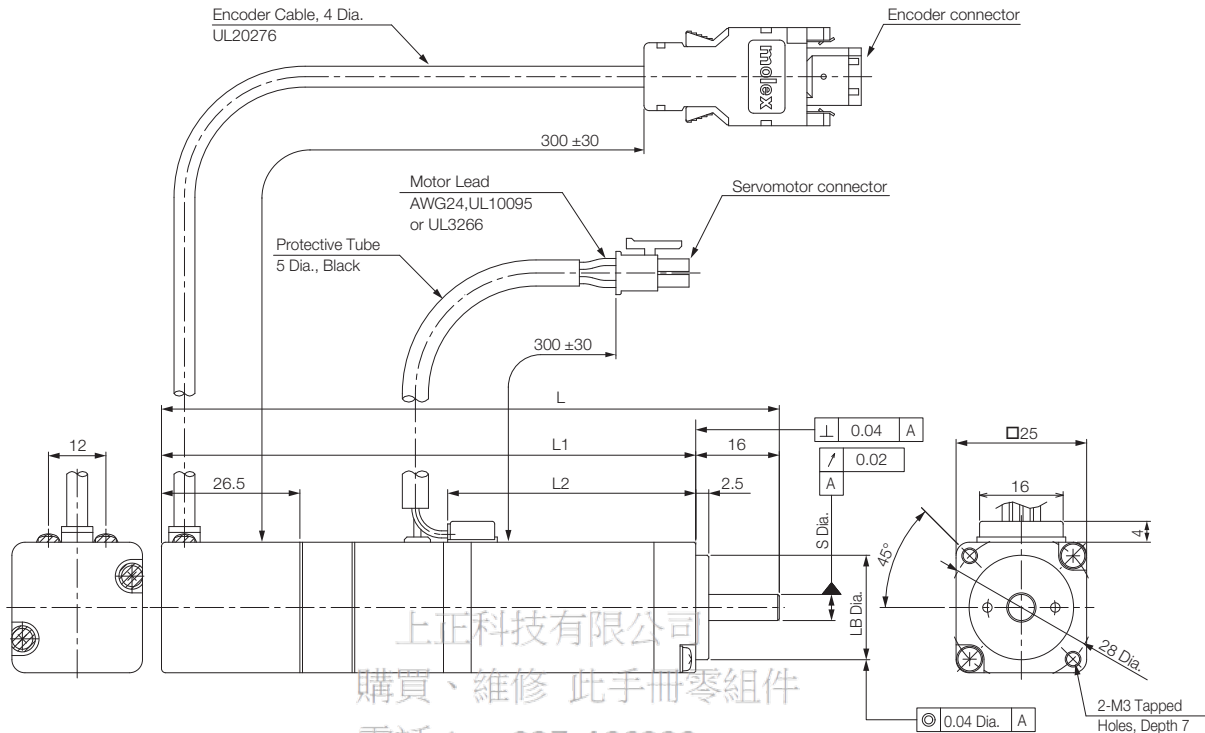

上正科技有限公司
購買、維修 此手冊零組件
電話： 037-466333

Model SGMMV-	L	L1	L2	Flange Dimensions		Approx. Mass [kg]
				S	LB	
A1A2A□C	94.5	78.5	27.5	5 ⁰ _{-0.008}	20 ⁰ _{-0.021}	0.215
A2A2A□C	108.5	92.5	37.5	5 ⁰ _{-0.008}	20 ⁰ _{-0.021}	0.27
A3A2A□C	118.5	102.5	47.5	5 ⁰ _{-0.008}	20 ⁰ _{-0.021}	0.31

■ Shaft End Specification

- Straight with Flat Seats

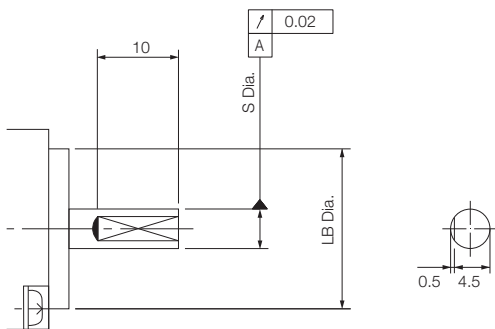

■ Connector Specifications

- Encoder Connector

1	PG5V	Red
2	PG0V	Black
3*	BAT	Orange
4*	BAT0	Orange/white
5	PS	Light blue
6	/PS	Light blue/white
Connector case	FG (frame ground)	Shield

* A battery is required only for an absolute encoder.

Model: 55102-0600

Manufacturer: Molex Japan LLC

Mating connector: 54280-0609

- Servomotor Connector

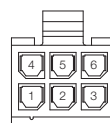

1	Phase U
2	Phase V
3	Phase W
4	FG (frame ground)
5	Brake
6	Brake

Receptacle: 43025-0600

Manufacturer: Molex Japan LLC

Selecting Cables

◆ Cable Configurations

The cables shown below are required to connect a Servomotor to a SERVOPACK.

Encoder Cable of 20 m or Less

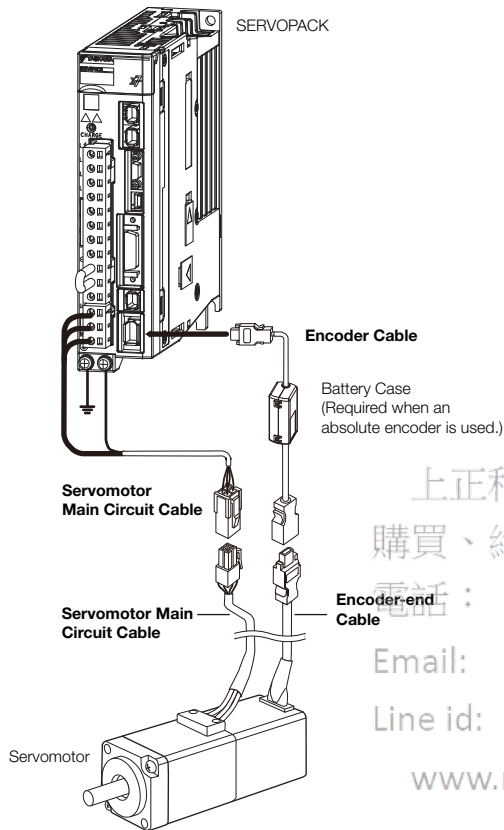

Encoder Cable of 30 m to 50 m (Relay Cable)

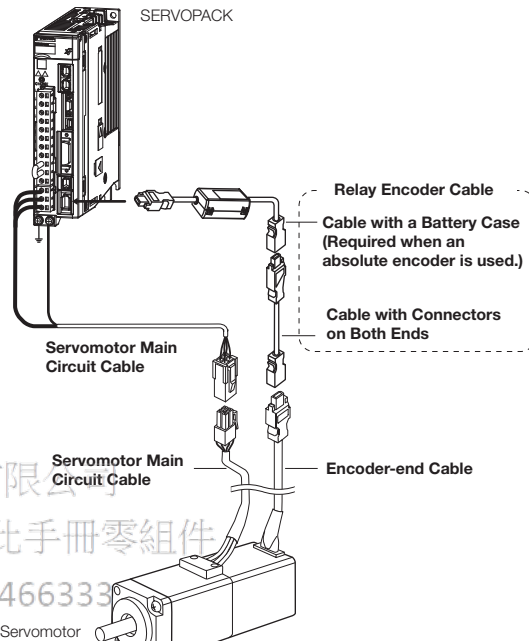

上正科技有限公司
購買、維修 此手冊零組件
電話：037-4663330
Email: service@repairtw.com
Line id: @zzzz
www.repairtw.com

Note: 1. If the Encoder Cable length exceeds 20 m, be sure to use a Relay Encoder Cable.

2. If you use a Servomotor Main Circuit Cable that exceeds 20 m, the intermittent duty zone in the torque-motor speed characteristics will become smaller because the voltage drop increases.

3. Refer to the following manual for the following information.

- Cable dimensional drawings and cable connection specifications
- Order numbers and specifications of individual connectors for cables
- Order numbers and specifications for wiring materials

📖 *Σ-7-Series AC Servo Drive Peripheral Device Selection Manual (Manual No.: SIEP S80001 32)*

◆ Servomotor Main Circuit Cables

Name	Length (L)	Order Number		Appearance
		Standard Cable	Flexible Cable*	
For Servomotors without Holding Brakes	3 m	JZSP-CF2M00-03-E	JZSP-CF2M20-03-E	
	5 m	JZSP-CF2M00-05-E	JZSP-CF2M20-05-E	
	10 m	JZSP-CF2M00-10-E	JZSP-CF2M20-10-E	
	15 m	JZSP-CF2M00-15-E	JZSP-CF2M20-15-E	
	20 m	JZSP-CF2M00-20-E	JZSP-CF2M20-20-E	
	30 m	JZSP-CF2M00-30-E	JZSP-CF2M20-30-E	
	40 m	JZSP-CF2M00-40-E	JZSP-CF2M20-40-E	
50 m	JZSP-CF2M00-50-E	JZSP-CF2M20-50-E		
For Servomotors with Holding Brakes	3 m	JZSP-CF2M03-03-E	JZSP-CF2M23-03-E	
	5 m	JZSP-CF2M03-05-E	JZSP-CF2M23-05-E	
	10 m	JZSP-CF2M03-10-E	JZSP-CF2M23-10-E	
	15 m	JZSP-CF2M03-15-E	JZSP-CF2M23-15-E	
	20 m	JZSP-CF2M03-20-E	JZSP-CF2M23-20-E	
	30 m	JZSP-CF2M03-30-E	JZSP-CF2M23-30-E	
	40 m	JZSP-CF2M03-40-E	JZSP-CF2M23-40-E	
50 m	JZSP-CF2M03-50-E	JZSP-CF2M23-50-E		

* Use Flexible Cables for moving parts of machines, such as robots. The recommended bending radius (R) is 90 mm or larger.

◆ Encoder Cables of 20 m or Less

Name	Length (L)	Order Number		Appearance
		Standard Cable	Flexible Cable*	
Cables with Connectors on Both Ends (for incremental encoder)	3 m	JZSP-CMP00-03-E	JZSP-CMP10-03-E	
	5 m	JZSP-CMP00-05-E	JZSP-CMP10-05-E	
	10 m	JZSP-CMP00-10-E	JZSP-CMP10-10-E	
	15 m	JZSP-CMP00-15-E	JZSP-CMP10-15-E	
	20 m	JZSP-CMP00-20-E	JZSP-CMP10-20-E	
Cables with Connectors on Both Ends (for absolute encoder: With Battery Case)	3 m	JZSP-CSP19-03-E	JZSP-CSP29-03-E	
	5 m	JZSP-CSP19-05-E	JZSP-CSP29-05-E	
	10 m	JZSP-CSP19-10-E	JZSP-CSP29-10-E	
	15 m	JZSP-CSP19-15-E	JZSP-CSP29-15-E	
	20 m	JZSP-CSP19-20-E	JZSP-CSP29-20-E	

* Use Flexible Cables for moving parts of machines, such as robots. The recommended bending radius (R) is 68 mm or larger.

◆ Relay Encoder Cables of 30 m to 50 m

Name	Length (L)	Order Number	Appearance
Cables with Connectors on Both Ends (for incremental or absolute encoder)	30 m	JZSP-UCMP00-30-E	
	40 m	JZSP-UCMP00-40-E	
	50 m	JZSP-UCMP00-50-E	
Cable with a Battery Case (Required when an absolute encoder is used.)*	0.3 m	JZSP-CSP12-E	

* This Cable is not required if a battery is connected to the host controller.

SGM7J

Model Designations

Without Gears

SGM7J - 01 A 7 A 2 1

1st+2nd digits 3rd digit 4th digit 5th digit 6th digit 7th digit

Σ-7 Series Servomotors: SGM7J

1st+2nd digits Rated Output

Code	Specification
A5	50 W
01	100 W
C2	150 W
02	200 W
04	400 W
06	600 W
08	750 W

3rd digit Power Supply Voltage

Code	Specification
A	200 VAC

4th digit Serial Encoder

Code	Specification
6	24-bit batteryless absolute
7	24-bit absolute
F	24-bit incremental

5th digit Design Revision Order

Code	Specification
A	

6th digit Shaft End

Code	Specification
2	Straight without key
6	Straight with key and tap
B	With two flat seats

7th digit Options

Code	Specification
1	Without options
C	With holding brake (24 VDC)
E	With oil seal and holding brake (24 VDC)
S	With oil seal

With Gears

SGM7J - 01 A 7 A H 1 2 1

1st+2nd digits 3rd digit 4th digit 5th digit 6th digit 7th digit 8th digit 9th digit

Σ-7 Series Servomotors: SGM7J

1st+2nd digits Rated Output

Code	Specification
A5	50 W
01	100 W
C2	150 W
02	200 W
04	400 W
06	600 W
08	750 W

5th digit Design Revision Order

Code	Specification
A	

6th digit Gear Type

Code	Specification
H	HDS planetary low-backlash gear

7th digit Gear Ratio

Code	Specification
B	1/11 ^{*1}
C	1/21
1	1/5
2	1/9 ^{*2}
7	1/33

8th digit Shaft End

Code	Specification
0	Flange output
2	Straight without key
6	Straight with key and tap

9th digit Options

Code	Specification
1	Without options
C	With holding brake (24 VDC)

3rd digit Power Supply Voltage

Code	Specification
A	200 VAC

4th digit Serial Encoder

Code	Specification
6	24-bit batteryless absolute
7	24-bit absolute
F	24-bit incremental

*1. This specification is not supported for models with a rated output of 50 W.

*2. This specification is supported only for models with a rated output of 50 W.

Specifications and Ratings

Specifications

Voltage		200 V						
Model SGM7J-		A5A	01A	C2A	02A	04A	06A	08A
Time Rating		Continuous						
Thermal Class		UL: B, CE: B						
Insulation Resistance		500 VDC, 10 MΩ min.						
Withstand Voltage		1,500 VAC for 1 minute						
Excitation		Permanent magnet						
Mounting		Flange-mounted						
Drive Method		Direct drive						
Rotation Direction		Counterclockwise (CCW) for forward reference when viewed from the load side						
Vibration Class* ¹		V15						
Environmental Conditions	Surrounding Air Temperature	0°C to 40°C (With derating, usage is possible between 40°C and 60°C.)* ³						
	Surrounding Air Humidity	20% to 80% relative humidity (with no condensation)						
	Installation Site	<ul style="list-style-type: none"> • Must be indoors and free of corrosive and explosive gases. • Must be well-ventilated and free of dust and moisture. • Must facilitate inspection and cleaning. • Must have an altitude of 1,000 m or less. (With derating, usage is possible between 1,000 m and 2,000 m.)*³ • Must be free of strong magnetic fields. 						
	Storage Environment	Store the Servomotor in the following environment if you store it with the power cable disconnected. Storage Temperature: -20°C to 60°C (with no freezing) Storage Humidity: 20% to 80% relative humidity (with no condensation)						
Shock Resistance* ²	Impact Acceleration Rate at Flange	490 m/s ²						
	Number of Impacts	2 times						
Vibration Resistance* ²	Vibration Acceleration Rate at Flange	49 m/s ²						
Applicable SERVO-PACKs	SGD7S-	R70A, R70F	R90A, R90F	1R6A, 2R1F		2R8A, 2R8F	5R5A	
	SGD7W-SGD7C-	1R6A* ⁴ , 2R8A* ⁴		1R6A, 2R8A* ⁴		2R8A, 5R5A* ⁴ , 7R6A* ⁴	5R5A, 7R6A	

*1. A vibration class of V15 indicates a vibration amplitude of 15 μm maximum on the Servomotor without a load at the rated motor speed.

*2. The given values are for when the Servomotor shaft is mounted horizontally and shock or vibration is applied in the directions shown in the following figures.

The strength of the vibration that the Servomotor can withstand depends on the application. Always check the vibration acceleration rate that is applied to the Servomotor with the actual equipment.

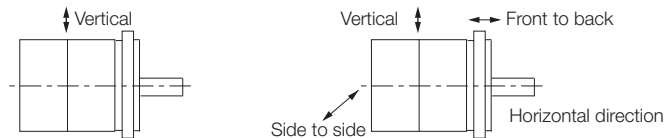

*3. Refer to the following section for the derating rates.

Derating Rates (page 22)

*4. If you use a Servomotor together with a Σ-7W or Σ-7C SERVOPACK, the control gain may not increase as much as with a Σ-7S SERVOPACK and other performances may be lower than those achieved with a Σ-7S SERVOPACK.

Ratings of Servomotors without Gears

Voltage		200 V							
Model SGM7J-		A5A	01A	C2A	02A	04A	06A	08A	
Rated Output* ¹	W	50	100	150	200	400	600	750	
Rated Torque* ^{1, *2}	N·m	0.159	0.318	0.477	0.637	1.27	1.91	2.39	
Instantaneous Maximum Torque* ¹	N·m	0.557	1.11	1.67	2.23	4.46	6.69	8.36	
Rated Current* ¹	Arms	0.55	0.85	1.6	1.6	2.5	4.2	4.4	
Instantaneous Maximum Current* ¹	Arms	2.0	3.1	5.7	5.8	9.3	15.3	16.9	
Rated Motor Speed* ¹	min ⁻¹	3000							
Maximum Motor Speed* ¹	min ⁻¹	6000							
Torque Constant	N·m/Arms	0.316	0.413	0.321	0.444	0.544	0.493	0.584	
Motor Moment of Inertia		0.0395	0.0659	0.0915	0.263	0.486	0.800	1.59	
	With holding brake	×10 ⁻⁴ kg·m ²	0.0475	0.0739	0.0995	0.333	0.556	0.870	1.77
	With batteryless absolute encoder		0.0410	0.0674	0.0930	0.264	0.487	0.801	1.59
Rated Power Rate* ¹		6.40	15.3	24.8	15.4	33.1	45.6	35.9	
	With holding brake	kW/s	5.32	13.6	22.8	12.1	29.0	41.9	32.2
Rated Angular Acceleration Rate* ¹		40200	48200	52100	24200	26100	23800	15000	
	With holding brake	rad/s ²	33400	43000	47900	19100	22800	21900	13500
Derating Rate for Servomotor with Oil Seal	%	80	90			95			
Heat Sink Size (Aluminum)* ³	mm	200 × 200 × 6			250 × 250 × 6				
Protective Structure* ⁴	Totally enclosed, self-cooled, IP67								
Holding Brake Specifications* ⁵	Rated Voltage	V	24 VDC±10%						
	Capacity	W	5.5	6		6.5			
	Holding Torque	N·m	0.159	0.318	0.477	0.637	1.27	1.91	2.39
	Coil Resistance	Ω (at 20°C)	104.8±10%			96±10%		88.6±10%	
	Rated Current	A (at 20°C)	0.23			0.25		0.27	
	Time Required to Release Brake	ms	60			80			
	Time Required to Brake	ms	100						
Allowable Load Moment of Inertia (Motor Moment of Inertia Ratio)* ⁶		35 times			15 times	10 times	20 times	12 times	
	With External Regenerative Resistor and External Dynamic Brake Resistor* ⁷	35 times			25 times		20 times	15 times	
Allowable Shaft Loads* ³	LF	mm	20			25		35	
	Allowable Radial Load	N	78			245		392	
	Allowable Thrust Load	N	54			74		147	

*1. These values are for operation in combination with a SERVOPACK when the temperature of the armature winding is 100°C. The values for other items are at 20°C. These are typical values.

*2. The rated torques are the continuous allowable torque values at a surrounding air temperature of 40°C with an aluminum heat sink of the dimensions given in the table.

*3. Refer to the following section for the relation between the heat sinks and derating rate.

 **Servomotor Heat Dissipation Conditions (page 22)**

*4. This does not apply to the shaft opening. Protective structure specifications apply only when the special cable is used.

*5. Observe the following precautions if you use a Servomotor with a Holding Brake.

- The holding brake cannot be used to stop the Servomotor.
- The time required to release the brake and the time required to brake depend on which discharge circuit is used. Confirm that the operation delay time is appropriate for the actual equipment.
- The 24-VDC power supply is not provided by Yaskawa.

*6. The motor moment of inertia scaling factor is the value for a standard Servomotor without a Holding Brake.

*7. To externally connect a dynamic brake resistor, select hardware option specification 020 for the SERVOPACK. However, you cannot externally connect a dynamic brake resistor if you use the following SERVOPACKs (maximum applicable motor capacity: 400 W).

- SGD7S-R70□□□A020 to -2R8□□□A020
- SGD7W-1R6A20A020 to -2R8A20A020
- SGD7C-1R6AMAA020 to -2R8AMAA020

*8. Design the mechanical system so that the thrust and radial loads applied to the Servomotor shaft end during operation do not exceed the values given in the table.

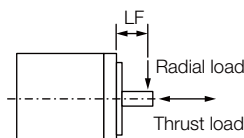

Ratings of Servomotors with Gears

All Models	Gear Mechanism		Protective Structure		Lost Motion [arc-min]	
	Planetary gear mechanism		Totally enclosed, self-cooled, IP55 (except for shaft opening)		3 max.	

Servomotor Model SGM7J-	Servomotor					Gear Output				
	Rated Output [W]	Rated Motor Speed [min ⁻¹]	Maximum Motor Speed [min ⁻¹]	Rated Torque [N·m]	Instantaneous Maximum Torque [N·m]	Gear Ratio	Rated Torque/ Efficiency ^{*1} [N·m/%]	Instantaneous Maximum Torque [N·m]	Rated Motor Speed [min ⁻¹]	Maximum Motor Speed [min ⁻¹]
A5A□AH1□	50	3000	6000	0.159	0.557	1/5	0.433/64 ^{*2}	2.37	600	1200
A5A□AH2□						1/9	1.12/78	3.78 ^{*3}	333	667
A5A□AHC□						1/21	2.84/85	10.6	143	286
A5A□AH7□						1/33	3.68/70	15.8	91	182
01A□AH1□	100	3000	6000	0.318	1.11	1/5	1.06/78 ^{*2}	4.96	600	1200
01A□AHB□						1/11	2.52/72	10.7	273	545
01A□AHC□						1/21	5.35/80	20.8	143	286
01A□AH7□						1/33	7.35/70	32.7	91	182
C2A□AH1□	150	3000	6000	0.477	1.67	1/5	1.68/83 ^{*2}	7.80	600	1200
C2A□AHB□						1/11	3.53/79 ^{*2}	16.9	273	545
C2A□AHC□						1/21	6.30/70 ^{*2}	31.0	143	286
C2A□AH7□						1/33	11.2/79 ^{*2}	49.7	91	182
02A□AH1□	200	3000	6000	0.637	2.23	1/5	2.39/75	9.80	600	1200
02A□AHB□						1/11	5.74/82	22.1	273	545
02A□AHC□						1/21	10.2/76	42.1	143	286
02A□AH7□						1/33	17.0/81	67.6	91	182
04A□AH1□	400	3000	6000	1.27	4.46	1/5	5.35/84	20.1	600	1200
04A□AHB□						1/11	11.5/82	45.1	273	545
04A□AHC□						1/21	23.0/86	87.0	143	286
04A□AH7□						1/33	34.0/81	135	91	182
06A□AH1□	600	3000	6000	1.91	6.69	1/5	7.54/79	30.5	600	1200
06A□AHB□						1/11	18.1/86	68.6	273	545
06A□AHC□						1/21	32.1/80	129	143	286
06A□AH7□						1/33	53.6/85	206	91	182
08A□AH1□	750	3000	6000	2.39	8.36	1/5	10.0/84	38.4	600	1200
08A□AHB□						1/11	23.1/88	86.4	273	545
08A□AHC□						1/21	42.1/84	163	143	286
08A□AH7□						1/33	69.3/88	259	91	182

*1. The gear output torque is expressed by the following formula.

$$\text{Gear output torque} = \text{Servomotor output torque} \times \frac{1}{\text{Gear ratio}} \times \text{Efficiency}$$

The gear efficiency depends on operating conditions such as the output torque, motor speed, and temperature. The values in the table are typical values for the rated torque, rated motor speed, and a surrounding air temperature of 25°C. They are reference values only.

*2. When using an SGM7J-A5A, SGM7J-01A, or SGM7J-C2A Servomotor with a gear ratio of 1/5 or an SGM7J-C2A Servomotor with a gear ratio of 1/11, maintain an 85% maximum effective load ratio. For an SGM7J-C2A Servomotor with a gear ratio of 1/21 or 1/33, maintain a 90% maximum effective load ratio. The values in the table take the effective load ratio into consideration.

*3. The instantaneous maximum torque is 300% of the rated torque.

Note: 1. The gears that are mounted to Yaskawa Servomotors have not been broken in.

Break in the Servomotor if necessary. First, operate the Servomotor at low speed with no load. If no problems occur, gradually increase the speed and load.

2. The no-load torque for a Servomotor with a Gear is high immediately after the Servomotor starts, and it then decreases and becomes stable after a few minutes.

This is a common phenomenon caused by grease circulation in the gears and it does not indicate faulty gears.

3. Other specifications are the same as those for Servomotors without Gears.



Important

The SERVOPACK speed control range is 1:5,000. If you use Servomotors at extremely low speeds (0.02 min⁻¹ or lower at the gear output shaft), if you use Servomotors with a one-pulse feed reference for extended periods, or under some other operating conditions, the gear bearing lubrication may be insufficient. That may cause deterioration of the bearing or increase the load ratio. Contact your Yaskawa representative if you use a Servomotor under these conditions.

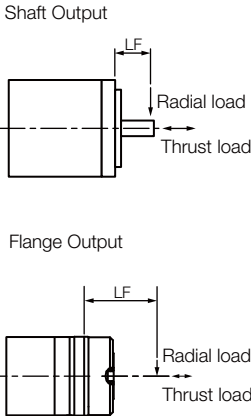
Servomotor Model SGM7J-	Moment of Inertia [$\times 10^{-4}$ kg·m ²]				With Gears			Reference Diagram
	Shaft Output		Flange Output		Allowable Radial Load [N]	Allowable Thrust Load [N]	LF [mm]	
	Motor* + Gear	Gear	Motor* + Gear	Gear				
A5A□AH1□	0.0455	0.006	0.0445	0.005	95	431	37	
A5A□AH2□	0.0425	0.003	0.0425	0.003	113	514	37	
A5A□AHC□	0.0435	0.004	0.0435	0.004	146	663	37	
A5A□AH7□	0.0845	0.045	0.0845	0.045	267	1246	53	
01A□AH1□	0.0719	0.006	0.0709	0.005	95	431	37	
01A□AHB□	0.126	0.060	0.125	0.059	192	895	53	
01A□AHC□	0.116	0.050	0.116	0.050	233	1087	53	
01A□AH7□	0.131	0.065	0.130	0.064	605	2581	75	
C2A□AH1□	0.0975	0.006	0.0965	0.005	95	431	37	
C2A□AHB□	0.152	0.060	0.151	0.059	192	895	53	
C2A□AHC□	0.202	0.110	0.200	0.108	528	2254	75	
C2A□AH7□	0.157	0.065	0.156	0.064	605	2581	75	
02A□AH1□	0.470	0.207	0.464	0.201	152	707	53	
02A□AHB□	0.456	0.193	0.455	0.192	192	895	53	
02A□AHC□	0.753	0.490	0.751	0.488	528	2254	75	
02A□AH7□	0.713	0.450	0.712	0.449	605	2581	75	
04A□AH1□	0.693	0.207	0.687	0.201	152	707	53	
04A□AHB□	1.06	0.570	1.05	0.560	435	1856	75	
04A□AHC□	0.976	0.490	0.974	0.488	528	2254	75	
04A□AH7□	1.11	0.620	1.10	0.610	951	4992	128	
06A□AH1□	1.50	0.700	1.46	0.660	343	1465	75	
06A□AHB□	1.37	0.570	1.36	0.560	435	1856	75	
06A□AHC□	1.64	0.840	1.62	0.820	830	4359	128	
06A□AH7□	1.42	0.620	1.41	0.610	951	4992	128	
08A□AH1□	2.29	0.700	2.25	0.660	343	1465	75	
08A□AHB□	2.19	0.600	2.18	0.590	435	1856	75	
08A□AHC□	4.59	3.00	4.57	2.98	830	4359	128	
08A□AH7□	4.39	2.80	4.37	2.78	951	4992	128	

* The moment of inertia for the Servomotor and gear is the value without a holding brake. You can calculate the moment of inertia for a Servomotor with a Gear and Holding Brake with the following formula.

Motor moment of inertia for a Servomotor with a Holding Brake from *Ratings of Servomotors without Gears* (page 16) + Moment of inertia for the gear from the above table.



Important

During operation, the gear generates the loss at the gear mechanism and oil seal. The loss depends on the torque and motor speed conditions. The temperature rise depends on the loss and heat dissipation conditions. For the heat dissipation conditions, always refer to the following table and check the gear and motor temperatures with the actual equipment. If the temperature is too high, implement the following measures.

- Decrease the load ratio.
- Change the heat dissipation conditions.
- Use forced-air cooling for the motor with a cooling fan or other means.

Model	Heat Sink Size			
	1/5	1/9 or 1/11	1/21	1/33
SGM7J-A5	A			
SGM7J-01	B			
SGM7J-C2	B			
SGM7J-02	B			
SGM7J-04	B			
SGM7J-06	C			
SGM7J-08	C			

- A: 250 mm × 250 mm × 6 mm, aluminum plate
- B: 300 mm × 300 mm × 12 mm, aluminum plate
- C: 350 mm × 350 mm × 12 mm, aluminum plate

Servomotor Overload Protection Characteristics

The overload detection level is set for hot start conditions with a Servomotor surrounding air temperature of 40°C.

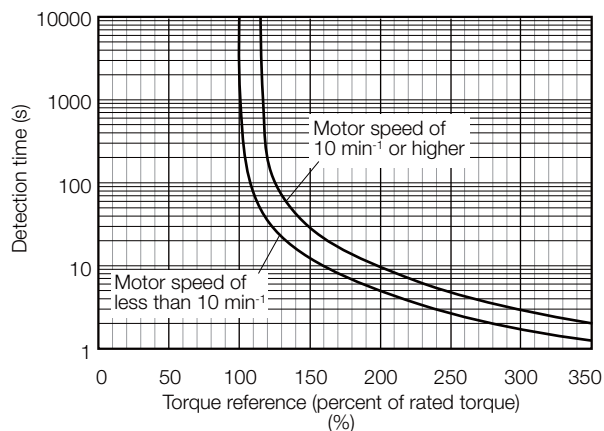

Note: The above overload protection characteristics do not mean that you can perform continuous duty operation with an output of 100% or higher.

Use the Servomotor so that the effective torque remains within the continuous duty zone given in *Torque-Motor Speed Characteristics* on page 17.

上正科技有限公司

購買、維修 此手冊零組件

電話： 037-466333

Email: service@repairtw.com

Line id: @zzzz

www.repairtw.com

Allowable Load Moment of Inertia

The allowable load moments of inertia (motor moment of inertia ratios) for the Servomotors are given in the *Ratings of Servomotors without Gears* (page 16). The values are determined by the regenerative energy processing capacity of the SERVOPACK and are also affected by the drive conditions of the Servomotor. Perform the required Steps for each of the following cases.

Use the SigmaSize+ AC Servo Drive Capacity Selection Program to check the driving conditions. Contact your Yaskawa representative for information on this program.

◆ Exceeding the Allowable Load Moment of Inertia

Use one of the following measures to adjust the load moment of inertia to within the allowable value.

- Reduce the torque limit.
- Reduce the deceleration rate.
- Reduce the maximum motor speed.

If the above steps is not possible, install an external regenerative resistor.

Information

An Overvoltage Alarm (A.400) is likely to occur during deceleration if the load moment of inertia exceeds the allowable load moment of inertia. SERVOPACKs with a built-in regenerative resistor may generate a Regenerative Overload Alarm (A.320). Refer to *Built-In Regenerative Resistor* (page 472) for the regenerative power (W) that can be processed by the SERVOPACKs.

Install an External Regenerative Resistor when the built-in regenerative resistor cannot process all of the regenerative power.

◆ SERVOPACKs without Built-in Regenerative Resistors

The following graph shows the allowable load moment of inertia scaling factor of the motor speed (reference values for deceleration operation at or above the rated torque). Application is possible without an external regenerative resistor within the allowable value. However, an External Regenerative Resistor is required in the shaded areas of the graphs.

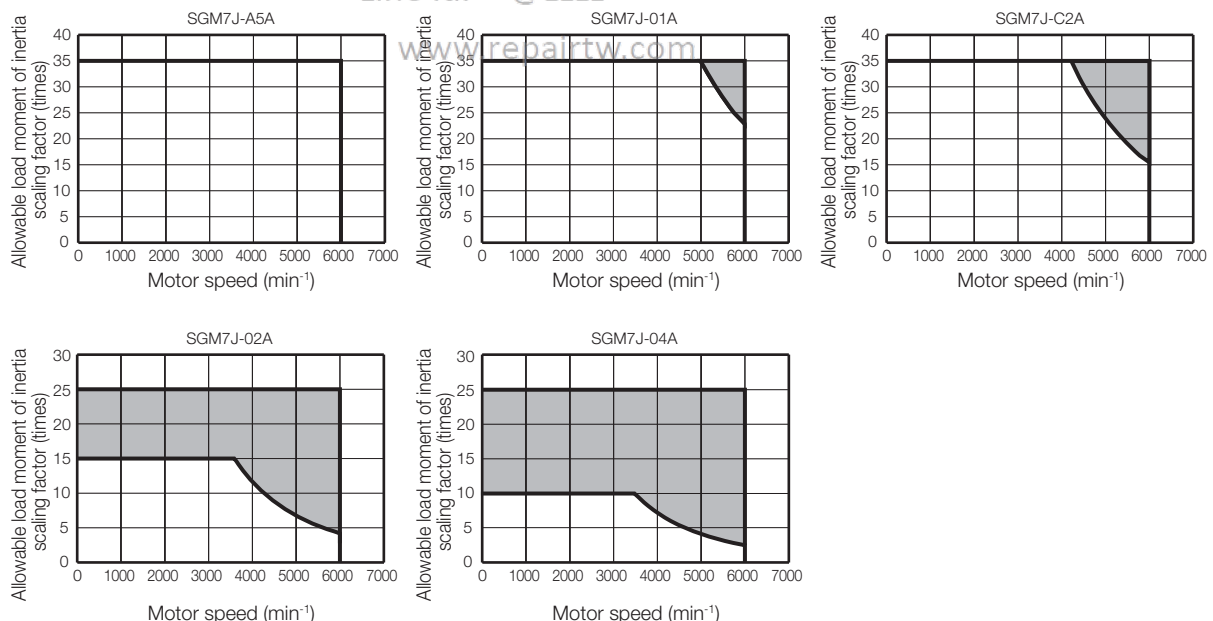

Note: Applicable SERVOPACK models: SGD7S-R70A, -R90A, -1R6A, -2R8A, -R70F, -R90F, -2R1F, and -2R8F

◆ When an External Regenerative Resistor Is Required

Install the External Regenerative Resistor. Refer to the following section for the recommended products.

External Regenerative Resistors (page 472)

Derating Rates

◆ Servomotor Heat Dissipation Conditions

The Servomotor ratings are the continuous allowable values at a surrounding air temperature of 40°C when a heat sink is installed on the Servomotor. If the Servomotor is mounted on a small device component, the Servomotor temperature may rise considerably because the surface for heat dissipation becomes smaller. Refer to the following graphs for the relation between the heat sink size and derating rate.

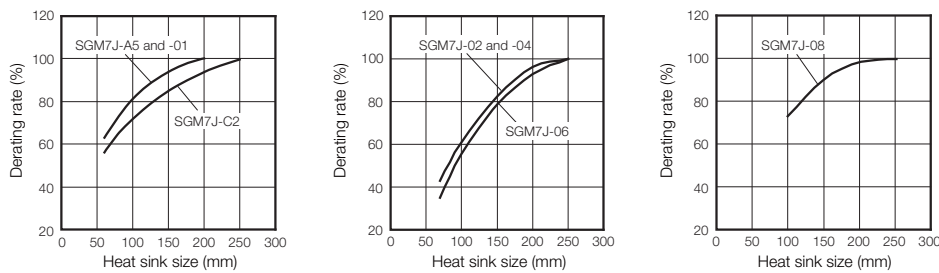

The actual temperature rise depends on how the heat sink (i.e., the Servomotor mounting section) is attached to the installation surface, what material is used for the Servomotor mounting section, and the motor speed. Always check the Servomotor temperature with the actual equipment.

◆ Applications Where the Surrounding Air Temperature Exceeds 40°C

The Servomotor ratings are the continuous allowable values at a surrounding air temperature of 40°C. If you use a Servomotor at a surrounding air temperature that exceeds 40°C (60°C max.), apply a suitable derating rate from the following graphs.

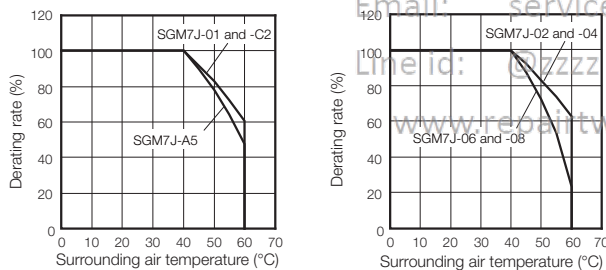

◆ Applications Where the Altitude Exceeds 1,000 m

The Servomotor ratings are the continuous allowable values at an altitude of 1,000 m or less. If you use a Servomotor at an altitude that exceeds 1,000 m (2,000 m max.), the heat dissipation effect of the air is reduced. Apply the appropriate derating rate from the following graphs.

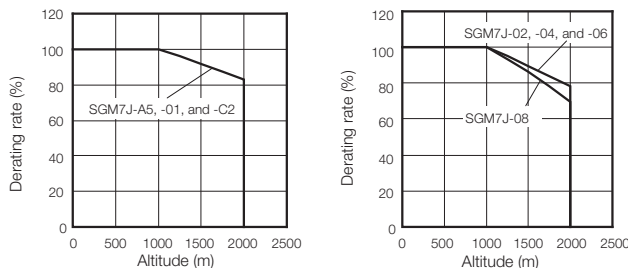

Information

When using Servomotors with derating, change the detection timing of overload warning and overload alarm based on the overload detection level of the motor given in *Servomotor Overload Protection Characteristics* (page 20).

Note: 1. Use the combination of the SERVOPACK and Servomotor so that the derating conditions are satisfied for both the SERVOPACK and Servomotor.

2. The derating rates are applicable only when the average motor speed is less than or equal to the rated motor speed. If the average motor speed exceeds the rated motor speed, consult with your Yaskawa representative.

External Dimensions

Servomotors without Gears

◆ SGM7J-A5, -01, and -C2

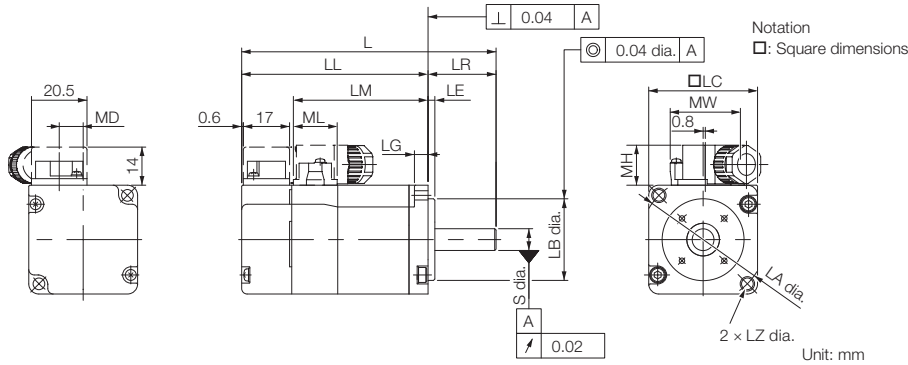

Model SGM7J-	L*	LL*	LM	Flange Dimensions							S	MD	MW	MH	ML	Approx. Mass [kg]
				LR	LE	LG	LC	LA	LB	LZ						
A5A□A2□	81.5 (122)	56.5 (97)	37.9	25	2.5	5	40	46	30 ⁰ _{-0.021}	4.3	8 ⁰ _{-0.009}	8.8	25.8	14.7	16.1	0.3 (0.6)
01A□A2□	93.5 (134)	68.5 (109)	49.9	25	2.5	5	40	46	30 ⁰ _{-0.021}	4.3	8 ⁰ _{-0.009}	8.8	25.8	14.7	16.1	0.4 (0.7)
C2A□A2□	105.5 (153.5)	80.5 (128.5)	61.9	25	2.5	5	40	46	30 ⁰ _{-0.021}	4.3	8 ⁰ _{-0.009}	8.8	25.8	14.7	16.1	0.5 (0.8)

* For models that have a batteryless absolute encoder, L and LL are 8 mm greater than the given value. Refer to the following section for the values for individual models.

☞ *Dimensions of Servomotors with Batteryless Absolute Encoders (page 32)*

Note: 1. The values in parentheses are for Servomotors with Holding Brakes.

2. The values for a straight, without key specification are given. Refer to the information given below for other shaft end specifications and option specifications.

■ Shaft End Specifications

- Straight with Key and Tap

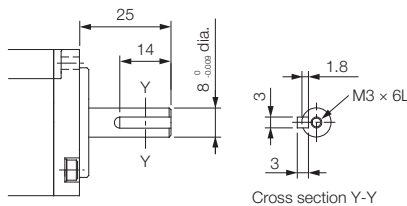

- With Two Flat Seats

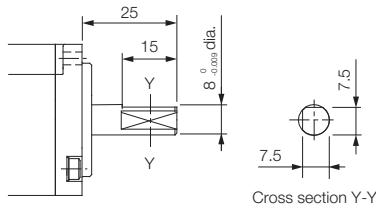

■ Specifications of Options

- Oil Seal

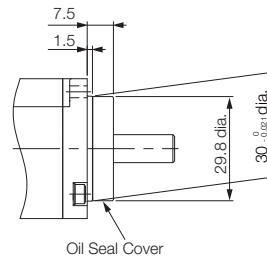

■ Connector Mounting Dimensions

- Cable Installed on Load Side

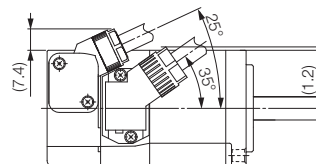

- Cable Installed on Non-load Side

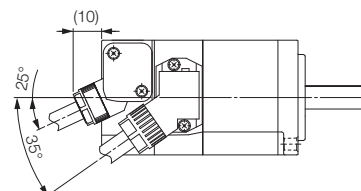

◆ SGM7J-02, -04, and -06

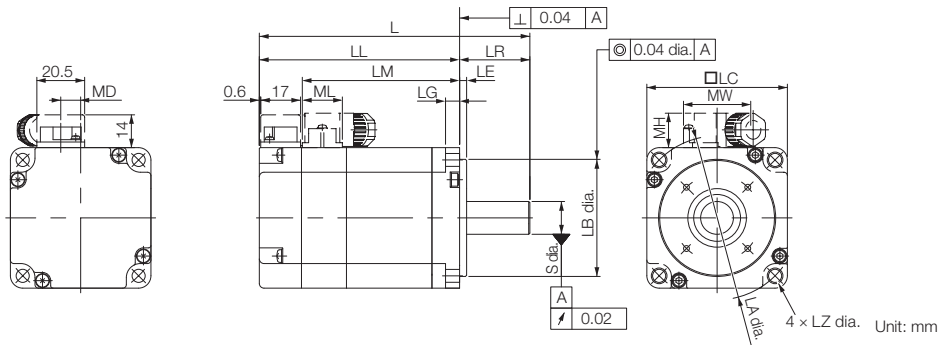

Model SGM7J-	L*	LL*	LM	Flange Dimensions							S	MD	MW	MH	ML	Approx. Mass [kg]
				LR	LE	LG	LC	LA	LB	LZ						
02A□A2□	99.5 (140)	69.5 (110)	51.2	30	3	6	60	70	50 ⁰ _{-0.025}	5.5	14 ⁰ _{-0.011}	8.5	28.7	14.7	17.1	0.8 (1.4)
04A□A2□	115.5 (156)	85.5 (126)	67.2	30	3	6	60	70	50 ⁰ _{-0.025}	5.5	14 ⁰ _{-0.011}	8.5	28.7	14.7	17.1	1.1 (1.7)
06A□A2□	137.5 (191.5)	107.5 (161.5)	89.2	30	3	6	60	70	50 ⁰ _{-0.025}	5.5	14 ⁰ _{-0.011}	8.5	28.7	14.7	17.1	1.6 (2.2)

* For models that have a batteryless absolute encoder, L and LL are 8 mm greater than the given value. Refer to the following section for the values for individual models.

🔗 **Dimensions of Servomotors with Batteryless Absolute Encoders** (page 32)

Note: 1. The values in parentheses are for Servomotors with Holding Brakes.

2. The values for a straight, without key specification are given. Refer to the information given below for other shaft end specifications and option specifications.

■ **Shaft End Specifications**

- Straight with Key and Tap

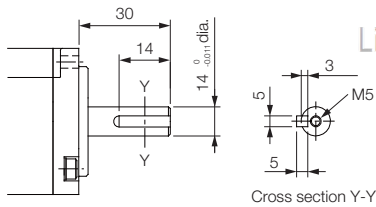

- With Two Flat Seats

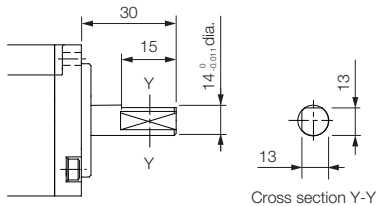

■ **Specifications of Options**

- Oil Seal

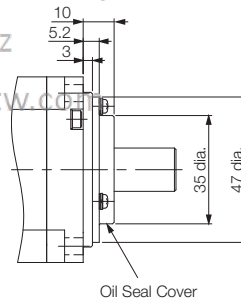

■ **Connector Mounting Dimensions**

- Cable Installed on Load Side

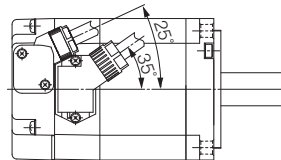

- Cable Installed on Non-load Side

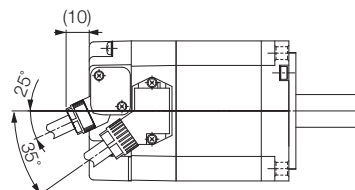

◆ SGM7J-08

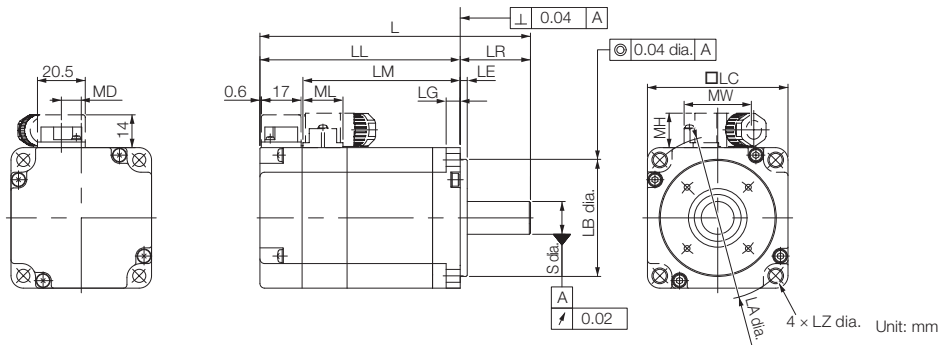

Model SGM7J-	L*	LL*	LM	Flange Dimensions							S	MD	MW	MH	ML	Approx. Mass* [kg]
				LR	LE	LG	LC	LA	LB	LZ						
08A□A2□	137 (184)	97 (144)	78.5	40	3	8	80	90	70 ⁰ _{-0.030}	7	19 ⁰ _{-0.013}	13.6	38	14.7	19.3	2.2 (2.8)

* For models that have a batteryless absolute encoder, L and LL are 8 mm greater and the approximate mass is 0.1 kg greater than the given value. Refer to the following section for the values for individual models.

🔧 **Dimensions of Servomotors with Batteryless Absolute Encoders (page 32)**

Note: 1. The values in parentheses are for Servomotors with Holding Brakes.

2. The values for a straight, without key specification are given. Refer to the information given below for other shaft end specifications and option specifications.

■ Shaft End Specifications

- Straight with Key and Tap

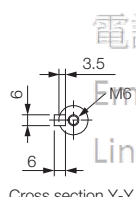
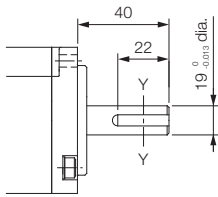

- With Two Flat Seats

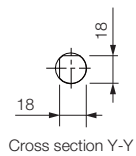
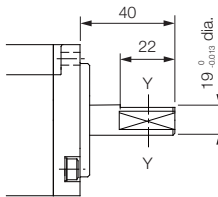

■ Specifications of Options

- Oil Seal

上正科技有限公司
電話：037-4663
Email: service@repairtw.com
Line id: @zzzz
www.repairtw.com

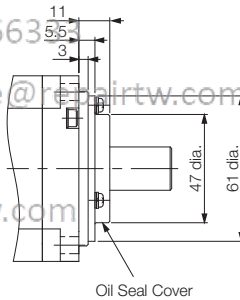

■ Connector Mounting Dimensions

- Cable Installed on Load Side

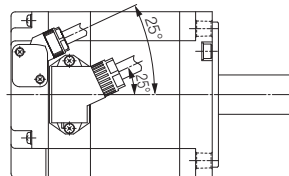

- Cable Installed on Non-load Side

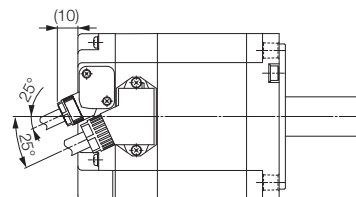

Servomotors with Gears

◆ SGM7J-A5, -01, and -C2

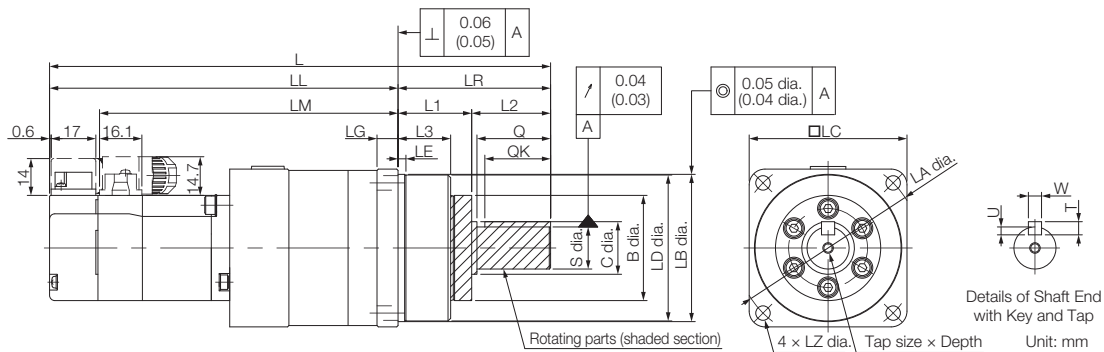

Model SGM7J-	Gear Ratio	L*	LL*	LM	Flange Dimensions									
					LR	LE	LG	B	LD	LB	LC	LA	LZ	
A5A□AH1□□	1/5	138	96	77.4										
A5A□AH2□□	1/9	(178.5)	(136.5)		42	2.2	5	29	39.5	40 ⁰ _{-0.025}	40	46	3.4	
A5A□AHC□□	1/21	147	105	86.4										
A5A□AH7□□	1/33	178.5	120.5	101.9	58	2.5	8	40	55.5	56 ⁰ _{-0.030}	60	70	5.5	
01A□AH1□□	1/5	150	108	89.4	42	2.2	5	29	39.5	40 ⁰ _{-0.025}	40	46	3.4	
01A□AHB□□	1/11	190.5	132.5	113.9	58	2.5	8	40	55.5	56 ⁰ _{-0.030}	60	70	5.5	
01A□AHC□□	1/21	(231)	(173)											
01A□AH7□□	1/33	215	135	116.4	80	7.5	10	59	84	85 ⁰ _{-0.035}	90	105	9	
C2A□AH1□□	1/5	162	120	101.4	42	2.2	5	29	39.5	40 ⁰ _{-0.025}	40	46	3.4	
C2A□AHB□□	1/11	202.5	144.5	125.9	58	2.5	8	40	55.5	56 ⁰ _{-0.030}	60	70	5.5	
C2A□AHC□□	1/21	227	147	128.4	80	7.5	10	59	84	85 ⁰ _{-0.035}	90	105	9	
C2A□AH7□□	1/33	(275)	(195)											

Model SGM7J-	Flange Dimensions			Q	C	S	Tap Size × Depth	Key Dimensions				Approx. Mass [kg]
	L1	L2	L3					QK	U	W	T	
A5A□AH1□□	22	20	14.6	-	-	10 ⁰ _{-0.015}	M3 × 6L	15	2.5	4	4	0.6 (0.9)
A5A□AH2□□												0.7 (1.0)
A5A□AHC□□												1.3 (1.6)
A5A□AH7□□	28	30	20	28	20	16 ⁰ _{-0.018}	M4 × 8L	25	3	5	5	2.8 (3.1)
01A□AH1□□	22	20	14.6	-	-	10 ⁰ _{-0.015}	M3 × 6L	15	2.5	4	4	0.7 (1.0)
01A□AHB□□	28	30	20	28	20	16 ⁰ _{-0.018}	M4 × 8L	25	3	5	5	1.4 (1.7)
01A□AHC□□												2.8 (3.1)
01A□AH7□□	36	44	26	42	32	25 ⁰ _{-0.021}	M6 × 12L	36	4	8	7	2.8 (3.1)
C2A□AH1□□	22	20	14.6	-	-	10 ⁰ _{-0.015}	M3 × 6L	15	2.5	4	4	0.8 (1.1)
C2A□AHB□□	28	30	20	28	20	16 ⁰ _{-0.018}	M4 × 8L	25	3	5	5	1.5 (1.8)
C2A□AHC□□	36	44	26	42	32	25 ⁰ _{-0.021}	M6 × 12L	36	4	8	7	2.9 (3.2)
C2A□AH7□□												2.9 (3.2)

* For models that have a batteryless absolute encoder, L and LL are 8 mm greater than the given value. Refer to the following section for the values for individual models.

🔧 Dimensions of Servomotors with Batteryless Absolute Encoders (page 32)

Note: 1. The values in parentheses are for Servomotors with Holding Brakes.

2. Gear dimensions are different from those of the Σ, Σ-II, and Σ-III Series.

3. The values for the shaft end are for a straight shaft with key and tap. If a key and tap are not necessary, specify shaft end code 2 for the 8th digit.

■ Flange Output Face

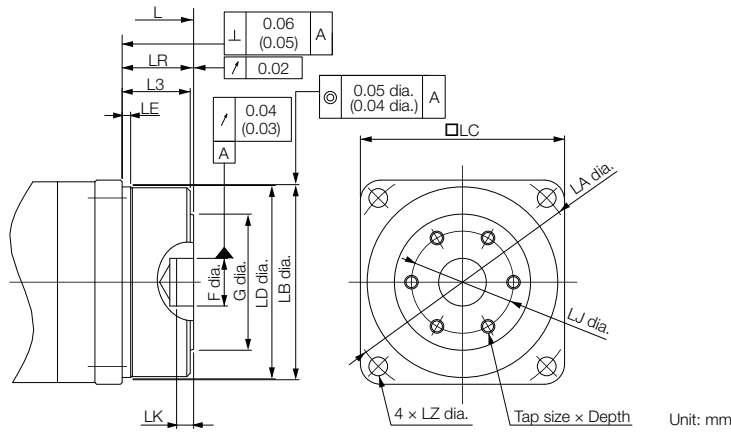

Note: The geometric tolerance in parentheses is the value for LC = 40.

Model SGM7J-	Gear Ratio	L*	LR	LJ	F	G	LK	No. of Taps × Tap Size × Depth	Approx. Mass [kg]
A5A□AH10□	1/5	111	15	18	5 ^{+0.012} ₀	24	3	3 × M4 × 6L	0.6 (0.9)
A5A□AH20□	1/9	(151.5)							
A5A□AHC0□	1/21	120 (160.5)							
A5A□AH70□	1/33	141.5 (182)	21	30	14 ^{+0.018} ₀	40	5	6 × M4 × 7L	1.2 (1.5)
O1A□AH10□	1/5	123 (163.5)	15	18	5 ^{+0.012} ₀	24	3	3 × M4 × 6L	0.7 (1.0)
O1A□AHB0□	1/11	153.5 (194)	21	30	14 ^{+0.018} ₀	40	5	3 × M4 × 7L	1.3 (1.6)
O1A□AHC0□	1/21	162 (202.5)							
O1A□AH70□	1/33	162 (202.5)	27	45	24 ^{+0.021} ₀	59	5	6 × M6 × 10L	2.4 (2.7)
C2A□AH10□	1/5	135 (183)	15	18	5 ^{+0.012} ₀	24	3	3 × M4 × 6L	0.8 (1.1)
C2A□AHB0□	1/11	165.5 (213.5)	21	30	14 ^{+0.018} ₀	40	5	6 × M4 × 7L	1.4 (1.7)
C2A□AHC0□	1/21	174 (222)	27	45	24 ^{+0.021} ₀	59	5	6 × M6 × 10L	2.5 (2.8)
C2A□AH70□	1/33								

* For models that have a batteryless absolute encoder, L is 8 mm greater than the given value. Refer to the following section for the values for individual models.

🔧 Dimensions of Servomotors with Batteryless Absolute Encoders (page 32)

Note: 1. The values in parentheses are for Servomotors with Holding Brakes.

2. Dimensions not found in the above table are the same as those in the table on the previous page.

Important For a Servomotor with a flange output that has square gear flange dimensions (□LC) of 40 mm, we recommend that you design the Servomotor with the dimensions shown in the following figure in order to secure a gap between the gear oil seal and the connecting parts on the load side.

0.5 min. Connecting parts on the load side
24 dia. max.

◆ SGM7J-02, -04, and -06

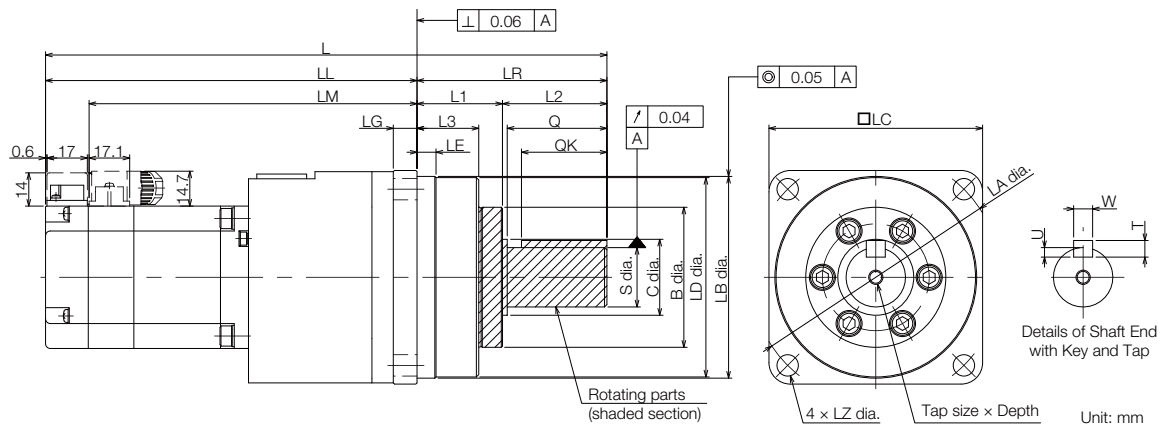

Model SGM7J-	Gear Ratio	L*	LL*	LM	Flange Dimensions								
					LR	LE	LG	B	LD	LB	LC	LA	LZ
02A□AH1□□	1/5	191.5	133.5	115.2	58	2.5	8	40	55.5	56 ⁰ _{-0.030}	60	70	5.5
02A□AHB□□	1/11	(232)	(174)										
02A□AHC□□	1/21	220.5	140.5	122.2	80	7.5	10	59	84	85 ⁰ _{-0.035}	90	105	9
02A□AH7□□	1/33	(261)	(181)										
04A□AH1□□	1/5	207.5	149.5	131.2	58	2.5	8	40	55.5	56 ⁰ _{-0.030}	60	70	5.5
04A□AHB□□	1/11	236.5	156.5										
04A□AHC□□	1/21	(277)	(197)	138.2	80	7.5	10	59	84	85 ⁰ _{-0.035}	90	105	9
04A□AH7□□	1/33	322.5	189.5	171.2	133	12.5	13	84	114	115 ⁰ _{-0.035}	120	135	11
06A□AH1□□	1/5	258.5	178.5	160.2	80	7.5	10	59	84	85 ⁰ _{-0.035}	90	105	9
06A□AHB□□	1/11	(312.5)	(232.5)										
06A□AHC□□	1/21	344.5	211.5	193.2	133	12.5	13	84	114	115 ⁰ _{-0.035}	120	135	11
06A□AH7□□	1/33	(398.5)	(265.5)										

Model SGM7J-	Flange Dimensions			Q	C	S	Tap Size × Depth	Key Dimensions				Approx. Mass [kg]
	L1	L2	L3					QK	U	W	T	
02A□AH1□□	28	30	20	28	20	16 ⁰ _{-0.018}	M4 × 8L	25	3	5	5	1.8 (2.4)
02A□AHB□□												1.9 (2.5)
02A□AHC□□	36	44	26	42	32	25 ⁰ _{-0.021}	M6 × 12L	36	4	8	7	3.7 (4.3)
02A□AH7□□												
04A□AH1□□	28	30	20	28	20	16 ⁰ _{-0.018}	M4 × 8L	25	3	5	5	2.1 (2.7)
04A□AHB□□	36	44	26	42	32	25 ⁰ _{-0.021}	M6 × 12L	36	4	8	7	4.0 (4.6)
04A□AHC□□												
04A□AH7□□	48	85	33	82	44	40 ⁰ _{-0.025}	M10 × 20L	70	5	12	8	8.6 (9.2)
06A□AH1□□	36	44	26	42	32	25 ⁰ _{-0.021}	M6 × 12L	36	4	8	7	4.3 (4.9)
06A□AHB□□												4.5 (5.1)
06A□AHC□□	48	85	33	82	44	40 ⁰ _{-0.025}	M10 × 20L	70	5	12	8	9.1 (9.7)
06A□AH7□□												

* For models that have a batteryless absolute encoder, L and LL are 8 mm greater than the given value. Refer to the following section for the values for individual models.

🔍 **Dimensions of Servomotors with Batteryless Absolute Encoders (page 32)**

- Note: 1. The values in parentheses are for Servomotors with Holding Brakes.
 2. Gear dimensions are different from those of the Σ, Σ-II, and Σ-III Series.
 3. The values for the shaft end are for a straight shaft with key and tap. If a key and tap are not necessary, specify shaft end code 2 for the 8th digit.

■ Flange Output Face

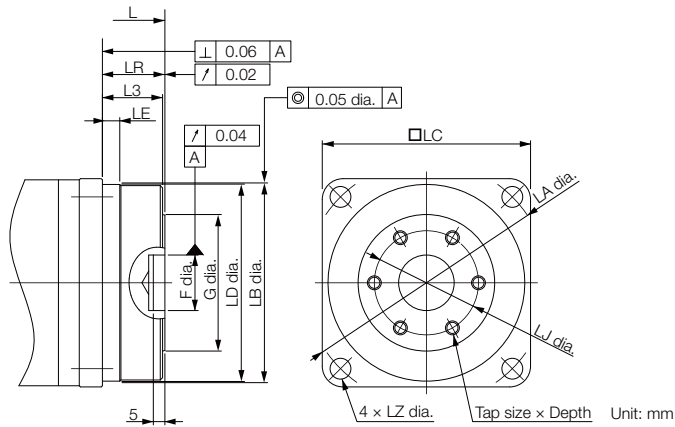

Model SGM7J-	Gear Ratio	L*	LR	LJ	F	G	No. of Taps × Tap Size × Depth	Approx. Mass [kg]
02A□AH10□	1/5	154.5 (195)	21	30	14 ^{+0.018} ₀	40	6 × M4 × 7L	1.7 (2.3)
02A□AHB0□	1/11							1.8 (2.4)
02A□AHC0□	1/21	167.5 (208)	27	45	24 ^{+0.021} ₀	59	6 × M6 × 10L	3.3 (3.9)
02A□AH70□	1/33							3.3 (3.9)
04A□AH10□	1/5	170.5 (211)	21	30	14 ^{+0.018} ₀	40	6 × M4 × 7L	2.0 (2.6)
04A□AHB0□	1/11							2.0 (2.6)
04A□AHC0□	1/21	183.5 (224)	27	45	24 ^{+0.021} ₀	59	6 × M6 × 10L	3.6 (4.2)
04A□AH70□	1/33							3.6 (4.2)
06A□AH10□	1/5	205.5 (259.5)	27	45	24 ^{+0.021} ₀	59	6 × M6 × 10L	3.9 (4.5)
06A□AHB0□	1/11							3.9 (4.5)
06A□AHC0□	1/21	246.5 (300.5)	35	60	32 ^{+0.025} ₀	84	6 × M8 × 12L	7.7 (8.3)
06A□AH70□	1/33							7.7 (8.3)

* For models that have a batteryless absolute encoder, L is 8 mm greater than the given value. Refer to the following section for the values for individual models.

📖 **Dimensions of Servomotors with Batteryless Absolute Encoders (page 32)**

Note: 1. The values in parentheses are for Servomotors with Holding Brakes.

2. Dimensions not found in the above table are the same as those in the table on the previous page.

◆ SGM7J-08

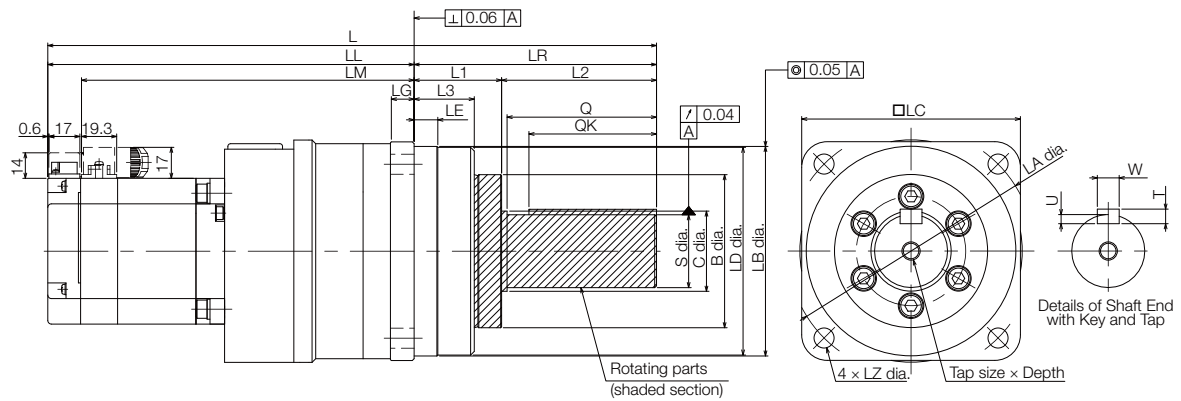

Unit: mm

Model SGM7J-	Gear Ratio	L*	LL*	LM	Flange Dimensions								
					LR	LE	LG	B	LD	LB	LC	LA	LZ
08A□AH1□□	1/5	255	175	156.5	80	7.5	10	59	84	85 ⁰ _{-0.035}	90	105	9
08A□AHB□□	1/11	(302)	(222)										
08A□AHC□□	1/21	334	201	182.5	133	12.5	13	84	114	115 ⁰ _{-0.035}	120	135	11
08A□AH7□□	1/33	(381)	(248)										

Model SGM7J-	Flange Dimensions			Q	C	S	Tap Size × Depth	Key Dimensions				Approx. Mass* [kg]
	L1	L2	L3					QK	U	W	T	
08A□AH1□□	36	44	26	42	32	25 ⁰ _{-0.021}	M6 × 12L	36	4	8	7	5.1 (5.7)
08A□AHB□□												5.3 (5.9)
08A□AHC□□	48	85	33	82	44	40 ⁰ _{-0.025}	M10 × 20L	70	5	12	8	10 (10.6)
08A□AH7□□												

* For models that have a batteryless absolute encoder, L and LL are 8 mm greater and the approximate mass is 0.1 kg greater than the given value. Refer to the following section for the values for individual models.

🔧 Dimensions of Servomotors with Batteryless Absolute Encoders (page 32)

- Note: 1. The values in parentheses are for Servomotors with Holding Brakes.
 2. Gear dimensions are different from those of the Σ, Σ-II, and Σ-III Series.
 3. The values for the shaft end are for a straight shaft with key and tap. If a key and tap are not necessary, specify shaft end code 2 for the 8th digit.

■ Flange Output Face

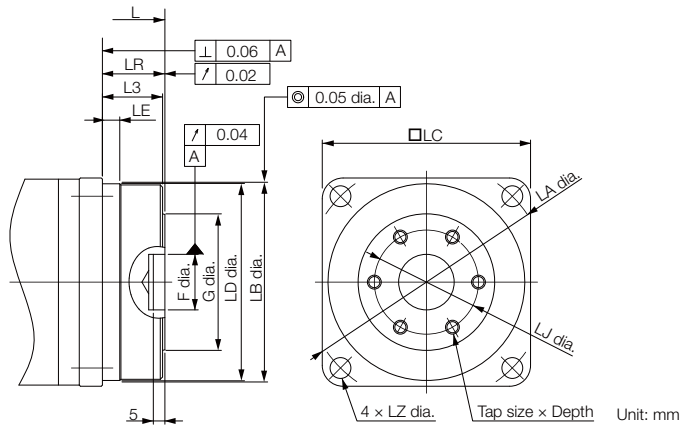

Model SGM7J-	Gear Ratio	L*	LR	LJ	F	G	No. of Taps × Tap Size × Depth	Approx. Mass* [kg]
08A□AH101	1/5	202 (249)	27	45	24 ^{+0.021} ₀	59	6 × M6 × 10L	4.7 (5.3)
08A□AHB01	1/11							4.9 (5.5)
08A□AHC01	1/21	236 (283)	35	60	32 ^{+0.025} ₀	84	6 × M8 × 12L	8.6 (9.2)
08A□AH701	1/33							

* For models that have a batteryless absolute encoder, L is 8 mm greater and the approximate mass is 0.1 kg greater than the given value. Refer to the following section for the values for individual models.

📏 **Dimensions of Servomotors with Batteryless Absolute Encoders (page 32)**

Note: 1. The values in parentheses are for Servomotors with Holding Brakes.

2. Dimensions not found in the above table are the same as those in the table on the previous page.

Email: service@repairtw.com

Line id: @zzzz

www.repairtw.com

Dimensions of Servomotors with Batteryless Absolute Encoders

◆ Servomotors without Gears

Model SGM7J-	L	LL	Approx. Mass [kg]
A5A6A2□	89.5 (130)	64.5 (105)	0.3 (0.6)
01A6A2□	101.5 (142)	76.5 (117)	0.4 (0.7)
C2A6A2□	113.5 (161.5)	88.5 (136.5)	0.5 (0.8)
02A6A2□	107.5 (148)	77.5 (118)	0.8 (1.4)
04A6A2□	123.5 (164)	93.5 (134)	1.1 (1.7)
06A6A2□	145.5 (198.5)	115.5 (169.5)	1.6 (2.2)
08A6A2□	145 (192)	105 (152)	2.3 (2.9)

Note: The values in parentheses are for Servomotors with Holding Brakes.

◆ Servomotors with Gears

• Shaft End Specification: Straight

Model SGM7J-	L	LL	Approx. Mass [kg]
A5A6AH1□□	146 (186.5)	104 (144.5)	0.6 (0.9)
A5A6AH2□□			
A5A6AHC□□	155 (195.5)	113 (153.5)	0.7 (1.7)
A5A6AH7□□	186.5 (227)	128.5 (169)	1.3 (1.6)
01A6AH1□□	158 (198.5)	116 (156.5)	0.7 (1.0)
01A6AHB□□	198.5 (239)	140.5 (181)	1.4 (1.7)
01A6AHC□□			
01A6AH7□□	223 (263.5)	143 (183.5)	2.8 (3.1)
C2A6AH1□□	170 (218)	128 (176)	0.8 (1.1)
C2A6AHB□□	210.5 (258.5)	152.5 (200.5)	1.5 (1.8)
C2A6AHC□□	235 (283)	155 (203)	2.9 (3.2)
C2A6AH7□□			
02A6AH1□□	191.5 (232)	141.5 (182.5)	1.8 (2.4)
02A6AHB□□			1.9 (2.5)
02A6AHC□□	228.5 (269)	148.5 (189)	3.7 (4.3)
02A6AH7□□			
04A6AH1□□	207.5 (248)	149.5 (198)	2.1 (2.7)
04A6AHB□□	236.5 (285)	184.5 (205)	4.0 (4.6)
04A6AHC□□			
04A6AH7□□	330.5 (371)	197.5 (238)	8.6 (9.2)
06A6AH1□□	266.5 (320.5)	186.5 (240.5)	4.3 (4.9)
06A6AHB□□			4.5 (5.1)
06A6AHC□□	352.5 (406.5)	219.5 (273.5)	9.1 (9.7)
06A6AH7□□			
08A6AH1□□	263 (310)	183 (230)	5.2 (5.8)
08A6AHB□□			5.4 (6.0)
08A6AHC□□	342 (389)	209 (256)	10.1 (10.7)
08A6AH7□□			

• Shaft End Specification: Flange Output

Model SGM7J-	L	Approx. Mass [kg]
A5A6AH10□	119 (159.5)	0.6 (0.9)
A5A6AH20□		
A5A6AHC0□	128 (168.5)	
A5A6AH70□	149.5 (190)	1.2 (1.5)
01A6AH10□	131 (171.5)	0.7 (1.0)
01A6AHB0□	161.5 (202)	1.3 (1.6)
01A6AHC0□		
01A6AH70□	170 (210.5)	2.4 (2.7)
C2A6AH10□	143 (191)	0.8 (1.1)
C2A6AHB0□	173.5 (221.5)	1.4 (1.7)
C2A6AHC0□	210.5 (258.5)	2.5 (2.8)
C2A6AH70□		
02A6AH10□	162.5 (203)	1.7 (2.3)
02A6AHB0□		1.8 (2.4)
02A6AHC0□	175.5 (216)	3.3 (3.9)
02A6AH70□		
04A6AH10□	178.5 (219)	2.0 (2.6)
04A6AHB0□	191.5 (232)	3.6 (4.2)
04A6AHC0□		
04A6AH70□	232.5 (273)	7.2 (7.8)
06A6AH10□	213.5 (267.5)	3.9 (4.5)
06A6AHB0□		4.1 (4.7)
06A6AHC0□	254.5 (308.5)	7.7 (8.3)
06A6AH70□		
08A6AH10□	210 (257)	4.8 (5.4)
08A6AHB0□		5.0 (5.6)
08A6AHC0□	244 (291)	8.7 (9.3)
08A6AH70□		

Note: The values in parentheses are for Servomotors with Holding Brakes.

Selecting Cables

◆ Cable Configurations

The cables shown below are required to connect a Servomotor to a SERVOPACK.

Encoder Cable of 20 m or Less

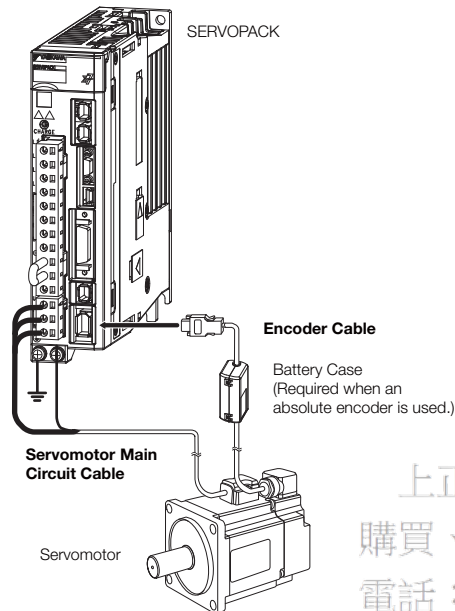

Encoder Cable of 30 m to 50 m (Relay Cable)

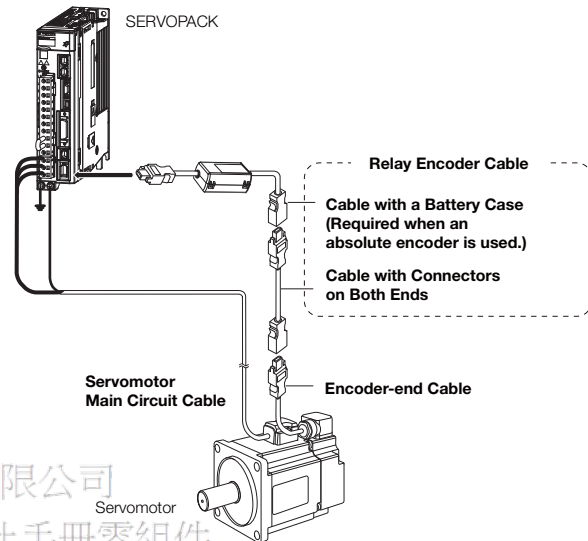

上正科技有限公司
購買、維修 此手冊零組件
電話： 037-466333

Note: 1. If the Encoder Cable length exceeds 20 m, be sure to use a Relay Encoder Cable.

2. If you use a Servomotor Main Circuit Cable that exceeds 20 m, the intermittent duty zone in the torque-speed characteristics will become smaller because the voltage drop increases.

3. Refer to the following manual for the following information.

- Cable dimensional drawings and cable connection specifications
- Order numbers and specifications of individual connectors for cables
- Order numbers and specifications for wiring materials

☞ *Σ-7-Series AC Servo Drive Peripheral Device Selection Manual (Manual No.: S1EP S80001 32)*



Important

There are different order numbers for the Servomotor Main Circuit Cables and Encoder Cables depending on the cable installation direction. Confirm the order numbers before you order.

Cable Installed toward Load

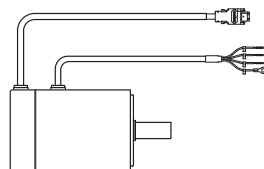

Cable Installed away from Load

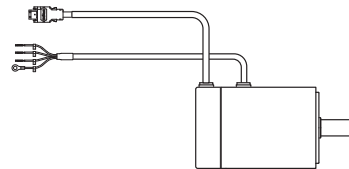

◆ Servomotor Main Circuit Cables

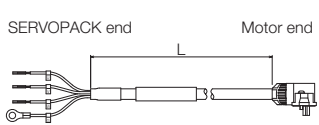
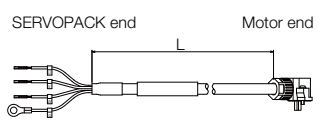
Servomotor Model	Name	Length (L)	Order Number		Appearance
			Standard Cable	Flexible Cable*	
SGM7J-A5 to -C2 50 W to 150 W		3 m	JZSP-C7M10F-03-E	JZSP-C7M12F-03-E	
		5 m	JZSP-C7M10F-05-E	JZSP-C7M12F-05-E	
		10 m	JZSP-C7M10F-10-E	JZSP-C7M12F-10-E	
		15 m	JZSP-C7M10F-15-E	JZSP-C7M12F-15-E	
		20 m	JZSP-C7M10F-20-E	JZSP-C7M12F-20-E	
		30 m	JZSP-C7M10F-30-E	JZSP-C7M12F-30-E	
		40 m	JZSP-C7M10F-40-E	JZSP-C7M12F-40-E	
		50 m	JZSP-C7M10F-50-E	JZSP-C7M12F-50-E	
SGM7J-02 to -06 200 W to 600 W	For Servo- motors with- out Holding Brakes	3 m	JZSP-C7M20F-03-E	JZSP-C7M22F-03-E	SERVOPACK end Motor end 
		5 m	JZSP-C7M20F-05-E	JZSP-C7M22F-05-E	
		10 m	JZSP-C7M20F-10-E	JZSP-C7M22F-10-E	
		15 m	JZSP-C7M20F-15-E	JZSP-C7M22F-15-E	
		20 m	JZSP-C7M20F-20-E	JZSP-C7M22F-20-E	
		30 m	JZSP-C7M20F-30-E	JZSP-C7M22F-30-E	
		40 m	JZSP-C7M20F-40-E	JZSP-C7M22F-40-E	
		50 m	JZSP-C7M20F-50-E	JZSP-C7M22F-50-E	
SGM7J-08 750 W, 1.0 kW		3 m	JZSP-C7M30F-03-E	JZSP-C7M32F-03-E	
		5 m	JZSP-C7M30F-05-E	JZSP-C7M32F-05-E	
		10 m	JZSP-C7M30F-10-E	JZSP-C7M32F-10-E	
		15 m	JZSP-C7M30F-15-E	JZSP-C7M32F-15-E	
		20 m	JZSP-C7M30F-20-E	JZSP-C7M32F-20-E	
		30 m	JZSP-C7M30F-30-E	JZSP-C7M32F-30-E	
		40 m	JZSP-C7M30F-40-E	JZSP-C7M32F-40-E	
		50 m	JZSP-C7M30F-50-E	JZSP-C7M32F-50-E	
SGM7J-A5 to -C2 50 W to 150 W		3 m	JZSP-C7M10G-03-E	JZSP-C7M12G-03-E	
		5 m	JZSP-C7M10G-05-E	JZSP-C7M12G-05-E	
		10 m	JZSP-C7M10G-10-E	JZSP-C7M12G-10-E	
		15 m	JZSP-C7M10G-15-E	JZSP-C7M12G-15-E	
		20 m	JZSP-C7M10G-20-E	JZSP-C7M12G-20-E	
		30 m	JZSP-C7M10G-30-E	JZSP-C7M12G-30-E	
		40 m	JZSP-C7M10G-40-E	JZSP-C7M12G-40-E	
		50 m	JZSP-C7M10G-50-E	JZSP-C7M12G-50-E	
SGM7J-02 to -06 200 W to 600 W	For Servo- motors with- out Holding Brakes	3 m	JZSP-C7M20G-03-E	JZSP-C7M22G-03-E	SERVOPACK end Motor end 
		5 m	JZSP-C7M20G-05-E	JZSP-C7M22G-05-E	
		10 m	JZSP-C7M20G-10-E	JZSP-C7M22G-10-E	
		15 m	JZSP-C7M20G-15-E	JZSP-C7M22G-15-E	
		20 m	JZSP-C7M20G-20-E	JZSP-C7M22G-20-E	
		30 m	JZSP-C7M20G-30-E	JZSP-C7M22G-30-E	
		40 m	JZSP-C7M20G-40-E	JZSP-C7M22G-40-E	
		50 m	JZSP-C7M20G-50-E	JZSP-C7M22G-50-E	
SGM7J-08 750 W, 1.0 kW		3 m	JZSP-C7M30G-03-E	JZSP-C7M32G-03-E	
		5 m	JZSP-C7M30G-05-E	JZSP-C7M32G-05-E	
		10 m	JZSP-C7M30G-10-E	JZSP-C7M32G-10-E	
		15 m	JZSP-C7M30G-15-E	JZSP-C7M32G-15-E	
		20 m	JZSP-C7M30G-20-E	JZSP-C7M32G-20-E	
		30 m	JZSP-C7M30G-30-E	JZSP-C7M32G-30-E	
		40 m	JZSP-C7M30G-40-E	JZSP-C7M32G-40-E	
		50 m	JZSP-C7M30G-50-E	JZSP-C7M32G-50-E	

* Use Flexible Cables for moving parts of machines, such as robots. The recommended bending radius (R) is 90 mm or larger.

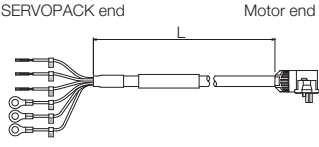
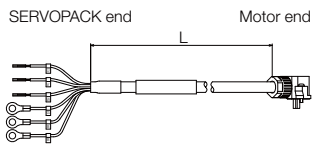
Servomotor Model	Name	Length (L)	Order Number		Appearance
			Standard Cable	Flexible Cable*	
SGM7J-A5 to -C2 50 W to 150 W		3 m	JZSP-C7M13F-03-E	JZSP-C7M14F-03-E	
		5 m	JZSP-C7M13F-05-E	JZSP-C7M14F-05-E	
		10 m	JZSP-C7M13F-10-E	JZSP-C7M14F-10-E	
		15 m	JZSP-C7M13F-15-E	JZSP-C7M14F-15-E	
		20 m	JZSP-C7M13F-20-E	JZSP-C7M14F-20-E	
		30 m	JZSP-C7M13F-30-E	JZSP-C7M14F-30-E	
		40 m	JZSP-C7M13F-40-E	JZSP-C7M14F-40-E	
		50 m	JZSP-C7M13F-50-E	JZSP-C7M14F-50-E	
SGM7J-02 to -06 200 W to 600 W	For Servo- motors with Holding Brakes	3 m	JZSP-C7M23F-03-E	JZSP-C7M24F-03-E	
		5 m	JZSP-C7M23F-05-E	JZSP-C7M24F-05-E	
		10 m	JZSP-C7M23F-10-E	JZSP-C7M24F-10-E	
		15 m	JZSP-C7M23F-15-E	JZSP-C7M24F-15-E	
		20 m	JZSP-C7M23F-20-E	JZSP-C7M24F-20-E	
		30 m	JZSP-C7M23F-30-E	JZSP-C7M24F-30-E	
		40 m	JZSP-C7M23F-40-E	JZSP-C7M24F-40-E	
		50 m	JZSP-C7M23F-50-E	JZSP-C7M24F-50-E	
SGM7J-08 750 W, 1.0 kW		3 m	JZSP-C7M33F-03-E	JZSP-C7M34F-03-E	
		5 m	JZSP-C7M33F-05-E	JZSP-C7M34F-05-E	
		10 m	JZSP-C7M33F-10-E	JZSP-C7M34F-10-E	
		15 m	JZSP-C7M33F-15-E	JZSP-C7M34F-15-E	
		20 m	JZSP-C7M33F-20-E	JZSP-C7M34F-20-E	
		30 m	JZSP-C7M33F-30-E	JZSP-C7M34F-30-E	
		40 m	JZSP-C7M33F-40-E	JZSP-C7M34F-40-E	
		50 m	JZSP-C7M33F-50-E	JZSP-C7M34F-50-E	
SGM7J-A5 to -C2 50 W to 150 W		3 m	JZSP-C7M13G-03-E	JZSP-C7M14G-03-E	
		5 m	JZSP-C7M13G-05-E	JZSP-C7M14G-05-E	
		10 m	JZSP-C7M13G-10-E	JZSP-C7M14G-10-E	
		15 m	JZSP-C7M13G-15-E	JZSP-C7M14G-15-E	
		20 m	JZSP-C7M13G-20-E	JZSP-C7M14G-20-E	
		30 m	JZSP-C7M13G-30-E	JZSP-C7M14G-30-E	
		40 m	JZSP-C7M13G-40-E	JZSP-C7M14G-40-E	
		50 m	JZSP-C7M13G-50-E	JZSP-C7M14G-50-E	
SGM7J-02 to -06 200 W to 600 W	For Servo- motors with Holding Brakes	3 m	JZSP-C7M23G-03-E	JZSP-C7M24G-03-E	
		5 m	JZSP-C7M23G-05-E	JZSP-C7M24G-05-E	
		10 m	JZSP-C7M23G-10-E	JZSP-C7M24G-10-E	
		15 m	JZSP-C7M23G-15-E	JZSP-C7M24G-15-E	
		20 m	JZSP-C7M23G-20-E	JZSP-C7M24G-20-E	
		30 m	JZSP-C7M23G-30-E	JZSP-C7M24G-30-E	
		40 m	JZSP-C7M23G-40-E	JZSP-C7M24G-40-E	
		50 m	JZSP-C7M23G-50-E	JZSP-C7M24G-50-E	
SGM7J-08 750 W, 1.0 kW		3 m	JZSP-C7M33G-03-E	JZSP-C7M34G-03-E	
		5 m	JZSP-C7M33G-05-E	JZSP-C7M34G-05-E	
		10 m	JZSP-C7M33G-10-E	JZSP-C7M34G-10-E	
		15 m	JZSP-C7M33G-15-E	JZSP-C7M34G-15-E	
		20 m	JZSP-C7M33G-20-E	JZSP-C7M34G-20-E	
		30 m	JZSP-C7M33G-30-E	JZSP-C7M34G-30-E	
		40 m	JZSP-C7M33G-40-E	JZSP-C7M34G-40-E	
		50 m	JZSP-C7M33G-50-E	JZSP-C7M34G-50-E	

* Use Flexible Cables for moving parts of machines, such as robots. The recommended bending radius (R) is 90 mm or larger.

◆ Encoder Cables of 20 m or Less

Servomotor Model	Name	Length (L)	Order Number		Appearance	
			Standard Cable	Flexible Cable* ¹		
All SGM7J models	For incremental encoder, or batteryless absolute encoder	3 m	JZSP-C7PI0D-03-E	JZSP-C7PI2D-03-E		
		5 m	JZSP-C7PI0D-05-E	JZSP-C7PI2D-05-E		
		10 m	JZSP-C7PI0D-10-E	JZSP-C7PI2D-10-E		
		Cable installed toward load	15 m	JZSP-C7PI0D-15-E		JZSP-C7PI2D-15-E
			20 m	JZSP-C7PI0D-20-E		JZSP-C7PI2D-20-E
	For incremental encoder, or batteryless absolute encoder	3 m	JZSP-C7PI0E-03-E	JZSP-C7PI2E-03-E		
		5 m	JZSP-C7PI0E-05-E	JZSP-C7PI2E-05-E		
		10 m	JZSP-C7PI0E-10-E	JZSP-C7PI2E-10-E		
		Cable installed away from load	15 m	JZSP-C7PI0E-15-E		JZSP-C7PI2E-15-E
			20 m	JZSP-C7PI0E-20-E		JZSP-C7PI2E-20-E
	For absolute encoder: With Battery Case* ²	Cable installed toward load	3 m	JZSP-C7PA0D-03-E	JZSP-C7PA2D-03-E	
			5 m	JZSP-C7PA0D-05-E	JZSP-C7PA2D-05-E	
			10 m	JZSP-C7PA0D-10-E	JZSP-C7PA2D-10-E	
		Cable installed away from load	15 m	JZSP-C7PA0D-15-E	JZSP-C7PA2D-15-E	
			20 m	JZSP-C7PA0D-20-E	JZSP-C7PA2D-20-E	
	For absolute encoder: With Battery Case* ²	Cable installed toward load	3 m	JZSP-C7PA0E-03-E	JZSP-C7PA2E-03-E	
			5 m	JZSP-C7PA0E-05-E	JZSP-C7PA2E-05-E	
			10 m	JZSP-C7PA0E-10-E	JZSP-C7PA2E-10-E	
		Cable installed away from load	15 m	JZSP-C7PA0E-15-E	JZSP-C7PA2E-15-E	
			20 m	JZSP-C7PA0E-20-E	JZSP-C7PA2E-20-E	

*1. Use Flexible Cables for moving parts of machines, such as robots. The recommended bending radius (R) is 90 mm or larger.

*2. If a battery is connected to the host controller, the Battery Case is not required. If so, use a cable for incremental encoders.

Line id: @zzzz

◆ Relay Encoder Cable of 30 m to 50 m

Servomotor Model	Name	Length (L)	Order Number	Appearance
All SGM7J models	Encoder-end Cable (for all types of encoders) Cable installed toward load	0.3 m	JZSP-C7PRCD-E	
	Encoder-end Cable (for all types of encoders) Cable installed away from load	0.3 m	JZSP-C7PRCE-E	
	Cables with Connectors on Both Ends (for all types of encoders)	30 m	JZSP-UCMP00-30-E	
		40 m	JZSP-UCMP00-40-E	
		50 m	JZSP-UCMP00-50-E	
Cable with a Battery Case (Required when an absolute encoder is used.*)	0.3 m	JZSP-CSP12-E		

* This Cable is not required if you use a Servomotor with a Batteryless Absolute Encoder, and you connect a battery to the host controller.

MEMO

上正科技有限公司
購買、維修 此手冊零組件
電話： 037-466333
Email: service@repairtw.com
Line id: @zzzz
www.repairtw.com

SGM7A

Model Designations

Without Gears

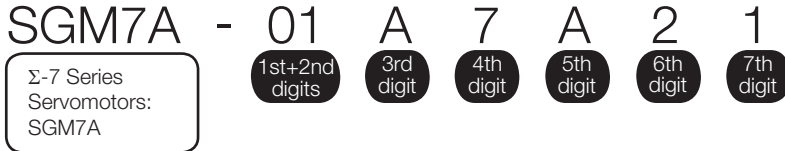

1st+2nd digits Rated Output

Code	Specification
A5	50 W
01	100 W
C2	150 W
02	200 W
04	400 W
06	600 W
08	750 W
10	1.0 kW
15	1.5 kW
20	2.0 kW
25	2.5 kW
30	3.0 kW
40	4.0 kW
50	5.0 kW
70	7.0 kW

3rd digit Power Supply Voltage

Code	Specification
A	200 VAC

4th digit Serial Encoder

Code	Specification
6	24-bit batteryless absolute
7	24-bit absolute
F	24-bit incremental

5th digit Design Revision Order

A

6th digit Shaft End

Code	Specification
2	Straight without key
6	Straight with key and tap
B*	With two flat seats

* Code B is not supported for models with a rated output of 1.5 kW or higher.

7th digit Options

Code	Specification
1	Without options
C	With holding brake (24 VDC)
E	With oil seal and holding brake (24 VDC)
S	With oil seal

Note: SGM7A-70A Servomotors with holding brakes are not available.

With Gears



1st+2nd digits Rated Output

Code	Specification
A5	50 W
01	100 W
C2	150 W
02	200 W
04	400 W
06	600 W
08	750 W
10	1.0 kW

4th digit Serial Encoder

Code	Specification
6	24-bit batteryless absolute
7	24-bit absolute
F	24-bit incremental

Note: Contact your Yaskawa representative for models of 1.5 kW or higher.

5th digit Design Revision Order

A

7th digit Gear Ratio

Code	Specification
B	1/11 ^{*1}
C	1/21
1	1/5
2	1/9 ^{*2}
7	1/33

*1. This specification is not supported for models with a rated output of 50 W.

*2. This specification is supported only for models with a rated output of 50 W.

3rd digit Power Supply Voltage

Code	Specification
A	200 VAC

6th digit Gear Type

Code	Specification
H	HDS planetary low-backlash gear

8th digit Shaft End

Code	Specification
0	Flange output
2	Straight without key
6	Straight with key and tap

9th digit Options

Code	Specification
1	Without options
C	With holding brake (24 VDC)

上正科技有限公司
 購買、維修 此手冊零組件
 電話： 037-466333

Email: service@repairtw.com

line id: @7zz
www.repairtw.com

Specifications and Ratings

Specifications

Voltage		200 V									
Model SGM7A-	A5A	01A	C2A, 02A	04A	06A, 08A	10A	15A	20A	25A, 30A	40A, 50A	70A
Time Rating	Continuous										
Thermal Class	UL: B, CE: B						UL: F, CE: F				
Insulation Resistance	500 VDC, 10 MΩ min.										
Withstand Voltage	1,500 VAC for 1 minute										
Excitation	Permanent magnet										
Mounting	Flange-mounted										
Drive Method	Direct drive										
Rotation Direction	Counterclockwise (CCW) for forward reference when viewed from the load side										
Vibration Class*1	V15										
Environmental Conditions	Surrounding Air Temperature	0°C to 40°C (With derating, usage is possible between 40°C and 60°C.)*3									
	Surrounding Air Humidity	20% to 80% relative humidity (with no condensation)									
	Installation Site	<ul style="list-style-type: none"> • Must be indoors and free of corrosive and explosive gases. • Must be well-ventilated and free of dust and moisture. • Must facilitate inspection and cleaning. • Must have an altitude of 1,000 m or less. (With derating, usage is possible between 1,000 m and 2,000 m.)*3 • Must be free of strong magnetic fields. 									
	Storage Environment	Store the Servomotor in the following environment if you store it with the power cable disconnected: Storage Temperature: -20°C to 60°C (with no freezing) Storage Humidity: 20% to 80% relative humidity (with no condensation)									
Shock Resistance*2	Impact Acceleration Rate at Flange	490 m/s ²									
	Number of Impacts	2 times									
Vibration Resistance*2	Vibration Acceleration Rate at Flange	49 m/s ² (Models 15A to 50A: 24.5 m/s ² front to back)									14.7 m/s ²
Applicable SERVOPACKs	SGD7S-	R70A, R70F	R90A, R90F	1R6A, 2R1F	2R8A, 2R8F	5R5A	120A	180A	200A	330A	550A
	SGD7W-SGD7C-	1R6A*4, 2R8A*4		1R6A, 2R8A*4	2R8A, 5R5A*4, 7R6A*4	5R5A, 7R6A	-				

*1. A vibration class of V15 indicates a vibration amplitude of 15 μm maximum on the Servomotor without a load at the rated motor speed.

*2. The given values are for when the Servomotor shaft is mounted horizontally and shock or vibration is applied in the directions shown in the following figures.

The strength of the vibration that the Servomotor can withstand depends on the application. Always check the vibration acceleration rate that is applied to the Servomotor with the actual equipment.

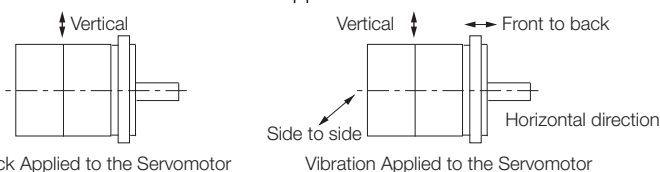

*3. Refer to the following section for the derating rates.

Derating Rates (page 48)

*4. If you use a Servomotor together with a Σ-7W or Σ-7C SERVOPACK, the control gain may not increase as much as with a Σ-7S SERVOPACK and other performances may be lower than those achieved with a Σ-7S SERVOPACK.

Ratings of Servomotors without Gears

Voltage		200 V								
Model SGM7A-		A5A	01A	C2A	02A	04A	06A	08A	10A	
Rated Output*1	W	50	100	150	200	400	600	750	1000	
Rated Torque*1, *2	N·m	0.159	0.318	0.477	0.637	1.27	1.91	2.39	3.18	
Instantaneous Maximum Torque*1	N·m	0.557	1.11	1.67	2.23	4.46	6.69	8.36	11.1	
Rated Current*1	Arms	0.57	0.89	1.5	1.5	2.4	4.5	4.4	6.4	
Instantaneous Maximum Current*1	Arms	2.1	3.2	5.6	5.9	9.3	16.9	16.8	23.2	
Rated Motor Speed*1	min ⁻¹	3000								
Maximum Motor Speed*1	min ⁻¹	6000								
Torque Constant	N·m/Arms	0.304	0.384	0.332	0.458	0.576	0.456	0.584	0.541	
Motor Moment of Inertia	×10 ⁻⁴ kg·m ²	0.0217	0.0337	0.0458	0.139	0.216	0.315	0.775	0.971	
With holding brake		0.0297	0.0417	0.0538	0.209	0.286	0.385	0.955	1.15	
With batteryless absolute encoder		0.0232	0.0352	0.0473	0.140	0.217	0.316	0.776	0.972	
Rated Power Rate*1	kW/s	11.7	30.0	49.7	29.2	74.7	115	73.7	104	
With holding brake		8.51	24.2	42.2	19.4	56.3	94.7	59.8	87.9	
Rated Angular Acceleration Rate*1	rad/s ²	73200	94300	104000	45800	58700	60600	30800	32700	
With holding brake		53500	76200	88600	30400	44400	49600	25000	27600	
Derating Rate for Servomotor with Oil Seal	%	80	90			95				
Heat Sink Size (Aluminum)*3	mm	200 × 200 × 6		250 × 250 × 6			300 × 300 × 12*9	250 × 250 × 6	300 × 300 × 12	
Protective Structure*4	Totally enclosed, self-cooled, IP67									
Holding Brake Specifications*5	Rated Voltage	24 VDC±10%								
	Capacity	5.5			6			6.5		
	Holding Torque	0.159	0.318	0.477	0.637	1.27	1.91	2.39	3.18	
	Coil Resistance	104.8±10%			96±10%			88.6±10%		
	Rated Current	0.23			0.25			0.27		
	Time Required to Release Brake	60						80		
	Time Required to Brake	100								
Allowable Load Moment of Inertia (Motor Moment of Inertia Ratio)*6		40 times			30 times	20 times		20 times		
	With External Regenerative Resistor and External Dynamic Brake Resistor*7	40 times			30 times	20 times		30 times		
Allowable Shaft Loads*8	LF	20			25		35			
	Allowable Radial Load	78			245		392			
	Allowable Thrust Load	54			74		147			

*1. These values are for operation in combination with a SERVOPACK when the temperature of the armature winding is 100°C. The values for other items are at 20°C. These are typical values.

*2. The rated torques are the continuous allowable torque values at a surrounding air temperature of 40°C with an aluminum heat sink of the dimensions given in the table.

*3. Refer to the following section for the relation between the heat sinks and derating rate.

 **Servomotor Heat Dissipation Conditions (page 48)**

*4. This does not apply to the shaft opening. Protective structure specifications apply only when the special cable is used.

*5. Observe the following precautions if you use a Servomotor with a Holding Brake.

- The holding brake cannot be used to stop the Servomotor.
- The time required to release the brake and the time required to brake depend on which discharge circuit is used. Confirm that the operation delay time is appropriate for the actual equipment.
- The 24-VDC power supply is not provided by Yaskawa.

*6. The motor moment of inertia scaling factor is the value for a standard Servomotor without a Holding Brake.

*7. To externally connect a dynamic brake resistor, select hardware option specification 020 for the SERVOPACK. However, you cannot externally connect a dynamic brake resistor if you use the following SERVOPACKs (maximum applicable motor capacity: 400 W).

- SGD7S-R70□□□A020 to -2R8□□□A020
- SGD7W-1R6A20A020 to -2R8A20A020
- SGD7C-1R6AMAA020 to -2R8AMAA020

*8. Design the mechanical system so that the thrust and radial loads applied to the Servomotor shaft end during operation do not exceed the values given in the table.

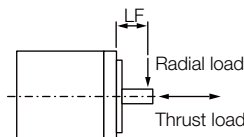

*9. If the heat sink is 250 mm × 250 mm × 6 mm, the rated output is 550 W and the rated torque is 1.75 N·m. Refer to the following section for details.

 **Servomotor Heat Dissipation Conditions (page 48)**

Ratings of Servomotors without Gears

Voltage		200 V						
Model SGM7A-		15A	20A	25A	30A	40A	50A	70A
Rated Output* ¹	kW	1.5	2.0	2.5	3.0	4.0	5.0	7.0
Rated Torque* ^{1, *2}	N·m	4.90	6.36	7.96	9.80	12.6	15.8	22.3
Instantaneous Maximum Torque* ¹	N·m	14.7	19.1	23.9	29.4	37.8	47.6	54.0
Rated Current* ¹	Arms	9.3	12.1	15.6	17.9	25.4	27.6	38.3
Instantaneous Maximum Current* ¹	Arms	28	42	51	56	77	84	105
Rated Motor Speed* ¹	min ⁻¹	3000						
Maximum Motor Speed* ¹	min ⁻¹	6000* ⁹						
Torque Constant	N·m/Arms	0.590	0.561	0.538	0.582	0.519	0.604	0.604
Motor Moment of Inertia	×10 ⁻⁴ kg·m ²	2.00	2.47	3.19	7.00	9.60	12.3	12.3
With holding brake		2.25	2.72	3.44	9.20	11.8	14.5	-
With batteryless absolute encoder		2.00	2.47	3.19	7.00	9.60	12.3	12.3
Rated Power Rate* ¹	kW/s	120	164	199	137	165	203	404
With holding brake		106	148	184	104	134	172	-
Rated Angular Acceleration Rate* ¹	rad/s ²	24500	25700	24900	14000	13100	12800	18100
With holding brake		21700	23300	23100	10600	10600	10800	-
Heat Sink Size (Aluminum)* ³	mm	300 × 300 × 12			400 × 400 × 20			
Protective Structure* ⁴	Totally enclosed, self-cooled, IP67							Totally enclosed, separately cooled (with fan), IP22
Holding Brake Specifications* ⁵	Rated Voltage	V	24 VDC ^{+10%} ₀					
	Capacity	W	12		10			
	Holding Torque	N·m	7.84		10			
	Coil Resistance	Ω (at 20°C)	48		59			
	Rated Current	A (at 20°C)	0.5		0.41			
	Time Required to Release Brake	ms	170		100			
	Time Required to Brake	ms	80		80			
Allowable Load Moment of Inertia (Motor Moment of Inertia Ratio)* ⁶	Line id: @zzl		10 times			5 times		
With External Regenerative Resistor and External Dynamic Brake Resistor* ⁷	www.repairtw.com		20 times			15 times		
Allowable Shaft Loads* ⁸	LF	mm	45		63			
	Allowable Radial Load	N	686		980	1176		
	Allowable Thrust Load	N	196		392			

*1. These values are for operation in combination with a SERVOPACK when the temperature of the armature winding is 20°C. These are typical values.

*2. The rated torques are the continuous allowable torque values at a surrounding air temperature of 40°C with an aluminum heat sink of the dimensions given in the table.

*3. Refer to the following section for the relation between the heat sinks and derating rate.

 **Servomotor Heat Dissipation Conditions (page 48)**

*4. This does not apply to the shaft opening. Protective structure specifications apply only when the special cable is used.

*5. Observe the following precautions if you use a Servomotor with a Holding Brake.

- The holding brake cannot be used to stop the Servomotor.
- The time required to release the brake and the time required to brake depend on which discharge circuit is used. Confirm that the operation delay time is appropriate for the actual equipment.
- The 24-VDC power supply is not provided by Yaskawa.

*6. The motor moment of inertia scaling factor is the value for a standard Servomotor without a Holding Brake.

*7. To externally connect a dynamic brake resistor, select hardware option specification 020 for the SERVOPACK. However, you cannot externally connect a dynamic brake resistor if you use the following SERVOPACKS (maximum applicable motor capacity: 400 W).

- SGD7S-R70□□□A020 to -2R8□□□A020
- SGD7W-1R6A20A020 to -2R8A20A020
- SGD7C-1R6AMAA020 to -2R8AMAA020

*8. Design the mechanical system so that the thrust and radial loads applied to the Servomotor shaft end during operation do not exceed the values given in the table.

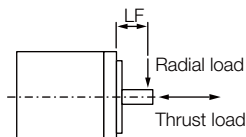

*9. For the SGM7A-25A or SGM7A-50A, the maximum motor speed for the continuous duty zone is 5,000 min⁻¹. Use the Servomotor within the continuous duty zone for the average motor speed and effective torque.

Torque-Motor Speed Characteristics

A : Continuous duty zone — (solid lines): With three-phase 200-V or single-phase 230-V input
B : Intermittent duty zone - - - (dotted lines): With single-phase 200-V input

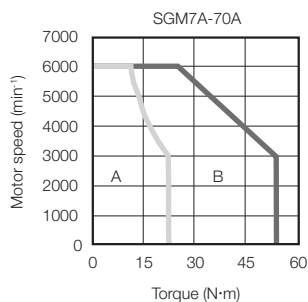
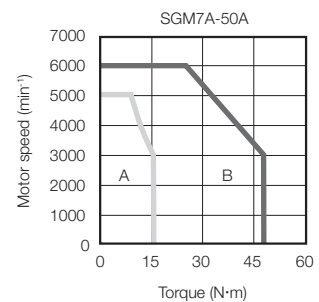
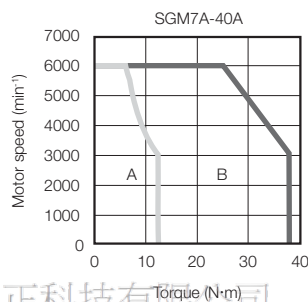
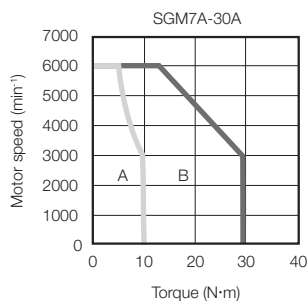
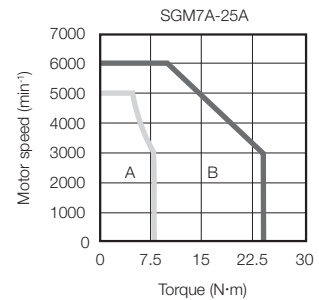
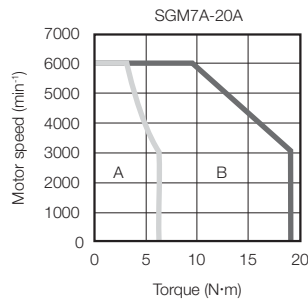
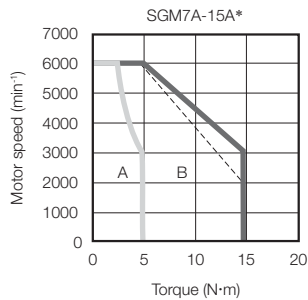

上正科技有限公司

購買、維修 此手冊零組件

電話： 037-466333

Email: service@repairtw.com

Line id: @zzzz

www.repairtw.com

* A single-phase power input can be used in combination with the SGD7S-120A□□A008.

Note: 1. These values (typical values) are for operation in combination with a SERVOPACK when the temperature of the armature winding is 20°C.

2. The characteristics in the intermittent duty zone depend on the power supply voltage.
3. If the effective torque is within the allowable range for the rated torque, the Servomotor can be used within the intermittent duty zone.
4. If you use a Servomotor Main Circuit Cable that exceeds 20 m, the intermittent duty zone in the torque-motor speed characteristics will become smaller because the voltage drop increases.

Ratings of Servomotors with Gears

All Models	Gear Mechanism		Protective Structure		Lost Motion [arc-min]	
	Planetary gear mechanism		Totally enclosed, self-cooled, IP55 (except for shaft opening)		3 max.	

Servomotor Model SGM7A-	Servomotor					Gear Output				
	Rated Output [W]	Rated Motor Speed [min ⁻¹]	Maximum Motor Speed [min ⁻¹]	Rated Torque [N·m]	Instantaneous Maximum Torque [N·m]	Gear Ratio	Rated Torque/Efficiency* ¹ [N·m/%]	Instantaneous Maximum Torque [N·m]	Rated Motor Speed [min ⁻¹]	Maximum Motor Speed [min ⁻¹]
A5A□AH1□	50	3000	6000	0.159	0.557	1/5	0.433/64* ²	2.37	600	1200
A5A□AH2□						1/9	1.12/78	3.78* ³	333	667
A5A□AHC□						1/21	2.84/85	10.6	143	286
A5A□AH7□						1/33	3.68/70	15.8	91	182
01A□AH1□	100	3000	6000	0.318	1.11	1/5	1.06/78* ²	4.96	600	1200
01A□AHB□						1/11	2.52/72	10.7	273	545
01A□AHC□						1/21	5.35/80	20.8	143	286
01A□AH7□						1/33	7.35/70	32.7	91	182
C2A□AH1□	150	3000	6000	0.477	1.67	1/5	1.68/83* ²	7.80	600	1200
C2A□AHB□						1/11	3.53/79* ²	16.9	273	545
C2A□AHC□						1/21	6.30/70* ²	31.0	143	286
C2A□AH7□						1/33	11.2/79* ²	49.7	91	182
02A□AH1□	200	3000	6000	0.637	2.23	1/5	2.39/75	9.80	600	1200
02A□AHB□						1/11	5.74/82	22.1	273	545
02A□AHC□						1/21	10.2/76	42.1	143	286
02A□AH7□						1/33	17.0/81	67.6	91	182
04A□AH1□	400	3000	6000	1.27	4.46	1/5	5.35/84	20.1	600	1200
04A□AHB□						1/11	11.5/82	45.1	273	545
04A□AHC□						1/21	23.0/86	87.0	143	286
04A□AH7□						1/33	34.0/81	135	91	182
06A□AH1□	600	3000	6000	1.91	6.69	1/5	7.54/79	30.5	600	1200
06A□AHB□						1/11	18.1/86	68.6	273	545
06A□AHC□						1/21	32.1/80	129	143	286
06A□AH7□						1/33	53.6/85	206	91	182
08A□AH1□	750	3000	6000	2.39	8.36	1/5	10.0/84	38.4	600	1200
08A□AHB□						1/11	23.1/88	86.4	273	545
08A□AHC□						1/21	42.1/84	163	143	286
08A□AH7□						1/33	69.3/88	259	91	182
10A□AH1□	1000	3000	6000	3.18	11.1	1/5	13.7/86	52.5	600	1200
10A□AHB□						1/11	29.1/83	111	273	545
10A□AHC□						1/21	58.2/87	215	143	286
10A□AH7□						1/33	94.5/90	296* ³	91	182

*1. The gear output torque is expressed by the following formula.

$$\text{Gear output torque} = \text{Servomotor output torque} \times \frac{1}{\text{Gear ratio}} \times \text{Efficiency}$$

The gear efficiency depends on operating conditions such as the output torque, motor speed, and temperature. The values in the table are typical values for the rated torque, rated motor speed, and a surrounding air temperature of 25°C. They are reference values only.

*2. When using an SGM7A-A5A, SGM7A-01A, or SGM7A-C2A Servomotor with a gear ratio of 1/5 or an SGM7A-C2A Servomotor with a gear ratio of 1/11, maintain an 85% maximum effective load ratio. For an SGM7A-C2A Servomotor with a gear ratio of 1/21 or 1/33, maintain a 90% maximum effective load ratio. The values in the table take the effective load ratio into consideration.

*3. The instantaneous maximum torque is 300% of the rated torque.

Note: 1. The gears that are mounted to Yaskawa Servomotors have not been broken in.

Break in the Servomotor if necessary. First, operate the Servomotor at low speed with no load. If no problems occur, gradually increase the speed and load.

2. The no-load torque for a Servomotor with a Gear is high immediately after the Servomotor starts, and it then decreases and becomes stable after a few minutes. This is a common phenomenon caused by grease circulation in the gears and it does not indicate faulty gears.

3. Contact your Yaskawa representative for information on Servomotor with Gears with a rated output of 1.5 kW or higher.

4. Other specifications are the same as those for Servomotors without Gears.



Important

The SERVOPACK speed control range is 1:5,000. If you use Servomotors at extremely low speeds (0.02 min⁻¹ or lower at the gear output shaft), if you use Servomotors with a one-pulse feed reference for extended periods, or under some other operating conditions, the gear bearing lubrication may be insufficient. That may cause deterioration of the bearing or increase the load ratio. Contact your Yaskawa representative if you use a Servomotor under these conditions.

Servomotor Model SGM7A-	Moment of Inertia [$\times 10^{-4}$ kg·m ²]				With Gears			Reference Diagram
	Shaft Output		Flange Output		Allowable Radial Load [N]	Allowable Thrust Load [N]	LF [mm]	
	Motor* + Gear	Gear	Motor* + Gear	Gear				
A5A□AH1□	0.0277	0.006	0.0267	0.005	95	431	37	
A5A□AH2□	0.0247	0.003	0.0247	0.003	113	514	37	
A5A□AHC□	0.0257	0.004	0.0257	0.004	146	663	37	
A5A□AH7□	0.0667	0.045	0.0667	0.045	267	1246	53	
01A□AH1□	0.0397	0.006	0.0387	0.005	95	431	37	
01A□AHB□	0.0937	0.060	0.0927	0.059	192	895	53	
01A□AHC□	0.0837	0.050	0.0837	0.050	233	1087	53	
01A□AH7□	0.0987	0.065	0.0977	0.064	605	2581	75	
C2A□AH1□	0.0518	0.006	0.0508	0.005	95	431	37	
C2A□AHB□	0.106	0.060	0.105	0.059	192	895	53	
C2A□AHC□	0.156	0.110	0.154	0.108	528	2254	75	
C2A□AH7□	0.111	0.065	0.110	0.064	605	2581	75	
02A□AH1□	0.346	0.207	0.340	0.201	152	707	53	
02A□AHB□	0.332	0.193	0.331	0.192	192	895	53	
02A□AHC□	0.629	0.490	0.627	0.488	528	2254	75	
02A□AH7□	0.589	0.450	0.588	0.449	605	2581	75	
04A□AH1□	0.423	0.207	0.417	0.201	152	707	53	
04A□AHB□	0.786	0.570	0.776	0.560	435	1856	75	
04A□AHC□	0.706	0.490	0.704	0.488	528	2254	75	
04A□AH7□	0.836	0.620	0.826	0.610	951	4992	128	
06A□AH1□	1.02	0.700	0.975	0.660	343	1465	75	
06A□AHB□	0.885	0.570	0.875	0.560	435	1856	75	
06A□AHC□	1.16	0.840	1.14	0.820	830	4359	128	
06A□AH7□	0.935	0.620	0.925	0.610	951	4992	128	
08A□AH1□	1.48	0.700	1.44	0.660	343	1465	75	
08A□AHB□	1.38	0.600	1.37	0.590	435	1856	75	
08A□AHC□	3.78	3.00	3.76	2.98	830	4359	128	
08A□AH7□	3.58	2.80	3.57	2.79	951	4992	128	
10A□AH1□	1.67	0.700	1.63	0.660	343	1465	75	
10A□AHB□	4.37	3.40	4.31	3.34	684	3590	128	
10A□AHC□	3.97	3.00	3.95	2.98	830	4359	128	
10A□AH7□	3.77	2.80	3.76	2.79	951	4992	128	

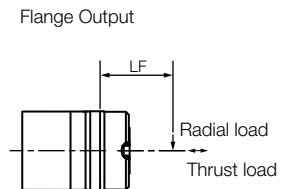
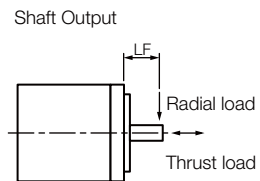

* The moment of inertia for the Servomotor and gear is the value without a holding brake. You can calculate the moment of inertia for a Servomotor with a Gear and Holding Brake with the following formula.

Motor moment of inertia for a Servomotor with a Holding Brake from *Ratings of Servomotors without Gears* (page 40) + Moment of inertia for the gear from the above table.



Important

During operation, the gear generates the loss at the gear mechanism and oil seal. The loss depends on the torque and motor speed conditions. The temperature rise depends on the loss and heat dissipation conditions. For the heat dissipation conditions, always refer to the following table and check the gear and motor temperatures with the actual equipment. If the temperature is too high, implement the following measures.

- Decrease the load ratio.
- Change the heat dissipation conditions.
- Use forced-air cooling for the motor with a cooling fan or other means.

Model	Heat Sink Size			
	1/5	1/9 or 1/11	1/21	1/33
SGM7A-A5	A			
SGM7A-01	B			
SGM7A-C2				
SGM7A-02	C			
SGM7A-04				
SGM7A-06				
SGM7A-08				
SGM7A-10A				

- A: 250 mm × 250 mm × 6 mm, aluminum plate
- B: 300 mm × 300 mm × 12 mm, aluminum plate
- C: 350 mm × 350 mm × 12 mm, aluminum plate

Servomotor Overload Protection Characteristics

The overload detection level is set for hot start conditions with a Servomotor surrounding air temperature of 40°C.

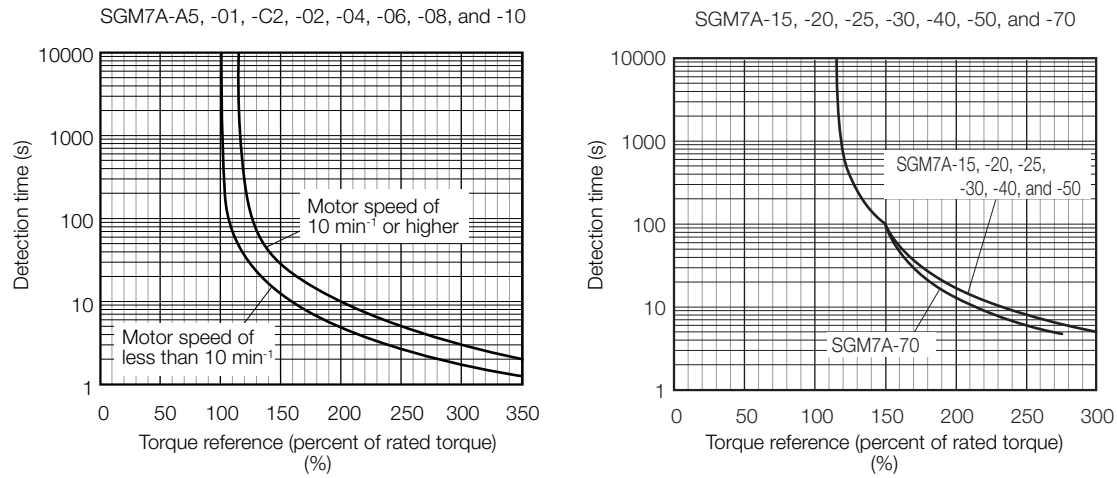

Note: The above overload protection characteristics do not mean that you can perform continuous duty operation with an output of 100% or higher. Use the Servomotor so that the effective torque remains within the continuous duty zone given in *Torque-Motor Speed Characteristics* on page 41 or page 43.

上正科技有限公司

購買、維修 此手冊零組件

電話： 037-466333

Email: service@repairtw.com

Line id: @zzzz

www.repairtw.com

Allowable Load Moment of Inertia

The allowable load moments of inertia (motor moment of inertia ratios) for the Servomotors are given in the *Ratings of Servomotors without Gears* (pages 40 and 42). The values are determined by the regenerative energy processing capacity of the SERVOPACK and are also affected by the drive conditions of the Servomotor. Perform the required Steps for each of the following cases.

Use the SigmaSize+ AC Servo Drive Capacity Selection Program to check the driving conditions. Contact your Yaskawa representative for information on this program.

◆ Exceeding the Allowable Load Moment of Inertia

Use one of the following measures to adjust the load moment of inertia to within the allowable value.

- Reduce the torque limit.
- Reduce the deceleration rate.
- Reduce the maximum motor speed.

If the above steps is not possible, install an external regenerative resistor.

Information

An Overvoltage Alarm (A.400) is likely to occur during deceleration if the load moment of inertia exceeds the allowable load moment of inertia. SERVOPACKs with a built-in regenerative resistor may generate a Regenerative Overload Alarm (A.320). Refer to *Built-In Regenerative Resistor* (page 472) for the regenerative power (W) that can be processed by the SERVOPACKs.

Install an External Regenerative Resistor when the built-in regenerative resistor cannot process all of the regenerative power.

◆ SERVOPACKs without Built-in Regenerative Resistors

The following graph shows the allowable load moment of inertia scaling factor of the motor speed (reference values for deceleration operation at or above the rated torque). Application is possible without an external regenerative resistor within the allowable value. However, an External Regenerative Resistor is required in the shaded areas of the graphs.

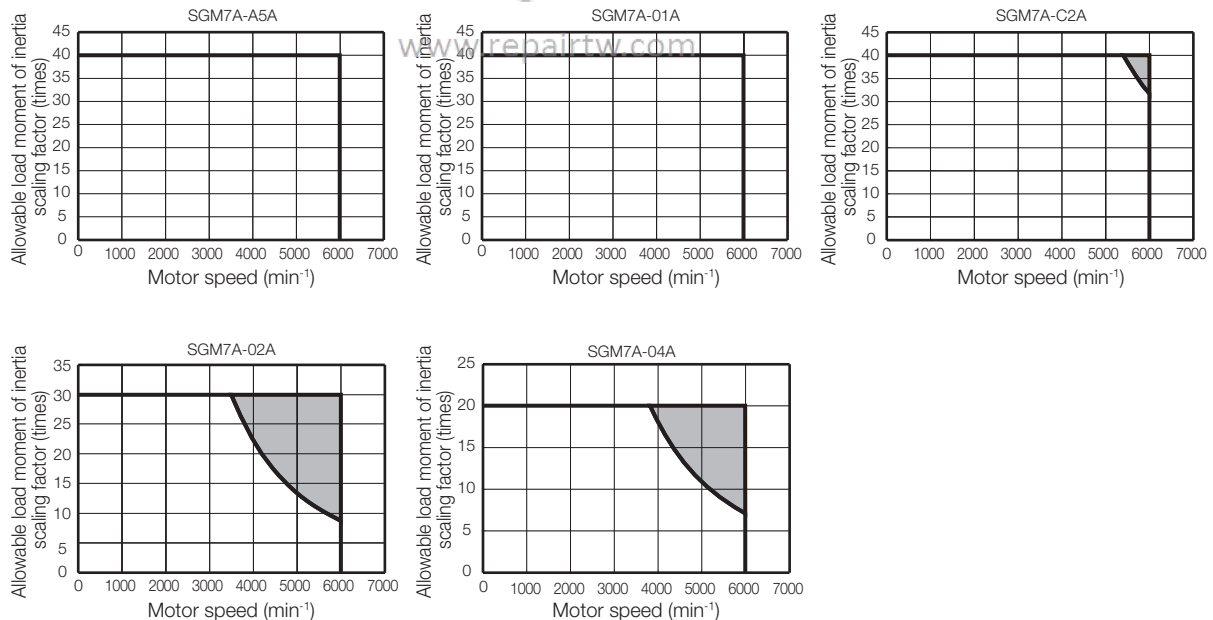

Note: Applicable SERVOPACK models: SGD7S-R70A, -R90A, -1R6A, -2R8A, -R70F, -R90F, -2R1F, and -2R8F

◆ When an External Regenerative Resistor Is Required

Install the External Regenerative Resistor. Refer to the following section for the recommended products.

External Regenerative Resistors (page 472)

Derating Rates

◆ Servomotor Heat Dissipation Conditions

The Servomotor ratings are the continuous allowable values at a surrounding air temperature of 40°C when a heat sink is installed on the Servomotor. If the Servomotor is mounted on a small device component, the Servomotor temperature may rise considerably because the surface for heat dissipation becomes smaller. Refer to the following graphs for the relation between the heat sink size and derating rate.

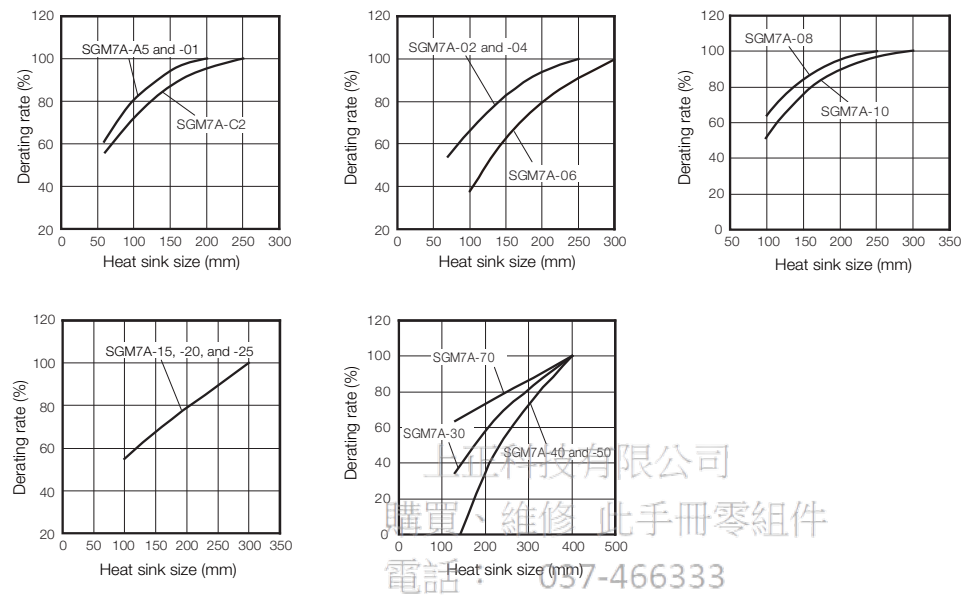

Important

The actual temperature rise depends on how the heat sink (i.e. the Servomotor mounting section) is attached to the installation surface, what material is used for the Servomotor mounting section, and the motor speed. Always check the Servomotor temperature with the actual equipment.

◆ Applications Where the Surrounding Air Temperature Exceeds 40°C

The Servomotor ratings are the continuous allowable values at a surrounding air temperature of 40°C. If you use a Servomotor at a surrounding air temperature that exceeds 40°C (60°C max.), apply a suitable derating rate from the following graphs.

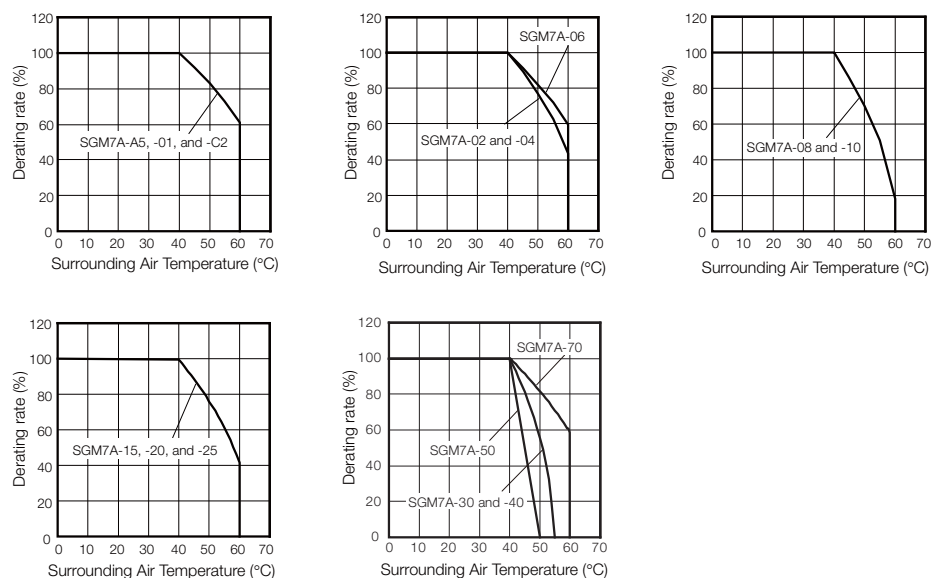

◆ Applications Where the Altitude Exceeds 1,000 m

The Servomotor ratings are the continuous allowable values at an altitude of 1,000 m or less. If you use a Servomotor at an altitude that exceeds 1,000 m (2,000 m max.), the heat dissipation effect of the air is reduced. Apply the appropriate derating rate from the following graphs.

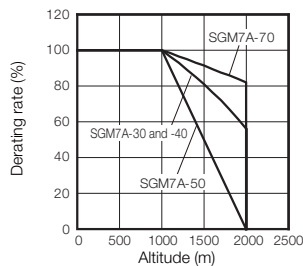
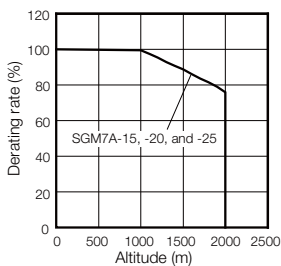
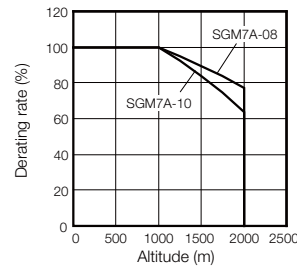
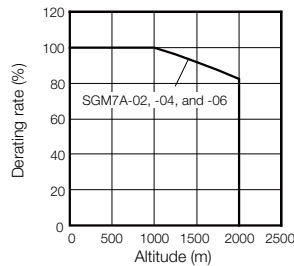
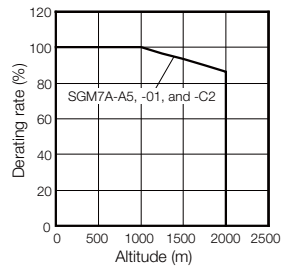

Information

When using Servomotors with derating, change the detection timing of overload warning and overload alarm based on the overload detection level of the motor given in *Servomotor Overload Protection Characteristics* (page 46).

- Note: 1. Use the combination of the SERVOPACK and Servomotor so that the derating conditions are satisfied for both the SERVOPACK and Servomotor.
2. The derating rates are applicable only when the average motor speed is less than or equal to the rated motor speed. If the average motor speed exceeds the rated motor speed, consult with your Yaskawa representative.

上海科技有限公司
 備有 維修 零件 組件
 Email: service@repairtw.com
 Line id: @zzzz
 www.repairtw.com

External Dimensions

Servomotors without Gears

◆ SGM7A-A5, -01, and -C2

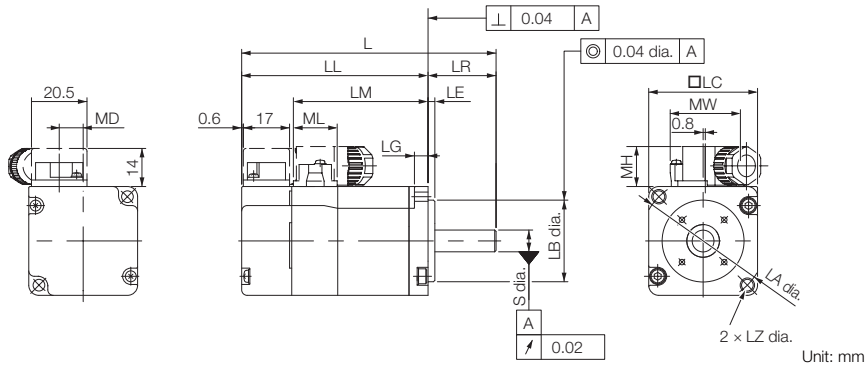

Model SGM7A-	L*	LL*	LM	Flange Dimensions							S	MD	MW	MH	ML	Approx. Mass [kg]
				LR	LE	LG	LC	LA	LB	LZ						
A5A□A2□	81.5 (122)	56.5 (97)	37.9	25	2.5	5	40	46	30 ⁰ _{-0.021}	4.3	8 ⁰ _{-0.009}	8.8	25.8	14.7	16.1	0.3 (0.6)
01A□A2□	93.5 (134)	68.5 (109)	49.9	25	2.5	5	40	46	30 ⁰ _{-0.021}	4.3	8 ⁰ _{-0.009}	8.8	25.8	14.7	16.1	0.4 (0.7)
C2A□A2□	105.5 (153.5)	80.5 (128.5)	61.9	25	2.5	5	40	46	30 ⁰ _{-0.021}	4.3	8 ⁰ _{-0.009}	8.8	25.8	14.7	16.1	0.5 (0.8)

* For models that have a batteryless absolute encoder, L and LL are 8 mm greater than the given value. Refer to the following section for the values for individual models.

☞ *Dimensions of Servomotors with Batteryless Absolute Encoders* (page 64)

Note: 1. The values in parentheses are for Servomotors with Holding Brakes.

2. The values for a straight, without key specification are given. Refer to the information given below for other shaft end specifications and option specifications.

■ Shaft End Specifications

- Straight with Key and Tap

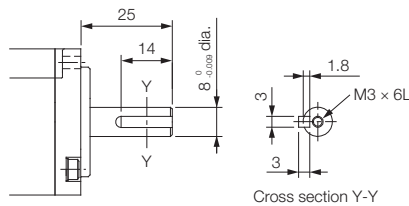

- With Two Flat Seats

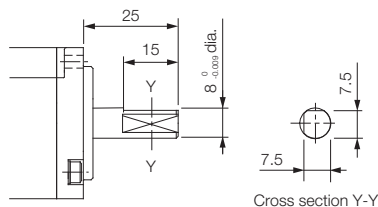

■ Specifications of Options

- Oil Seal

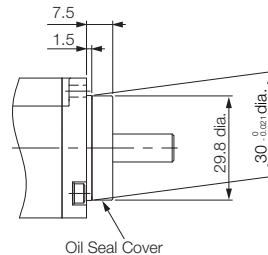

■ Connector Mounting Dimensions

- Cable Installed on Load Side

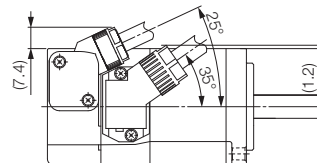

- Cable Installed on Non-load Side

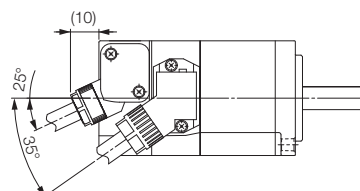

◆ SGM7A-02, -04, and -06

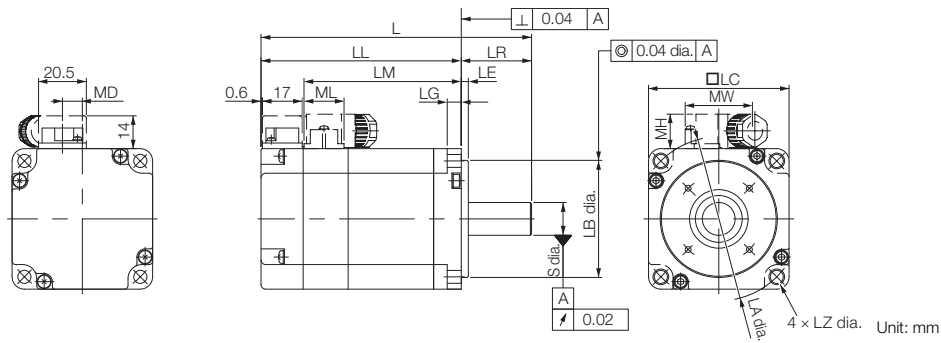

Model SGM7A-	L*	LL*	LM	Flange Dimensions							S	MD	MW	MH	ML	Approx. Mass [kg]
				LR	LE	LG	LC	LA	LB	LZ						
02A□A2□	99.5 (140)	69.5 (110)	51.2	30	3	6	60	70	50 ⁰ _{-0.025}	5.5	14 ⁰ _{-0.011}	8.5	28.7	14.7	17.1	0.8 (1.4)
04A□A2□	115.5 (156)	85.5 (126)	67.2	30	3	6	60	70	50 ⁰ _{-0.025}	5.5	14 ⁰ _{-0.011}	8.5	28.7	14.7	17.1	1.2 (1.8)
06A□A2□	137.5 (191.5)	107.5 (161.5)	89.2	30	3	6	60	70	50 ⁰ _{-0.025}	5.5	14 ⁰ _{-0.011}	8.5	28.7	14.7	17.1	1.6 (2.2)

* For models that have a batteryless absolute encoder, L and LL are 8 mm greater than the given value. Refer to the following section for the values for individual models.

🔧 **Dimensions of Servomotors with Batteryless Absolute Encoders (page 64)**

Note: 1. The values in parentheses are for Servomotors with Holding Brakes.

2. The values for a straight, without key specification are given. Refer to the information given below for other shaft end specifications and option specifications.

■ Shaft End Specifications

- Straight with Key and Tap

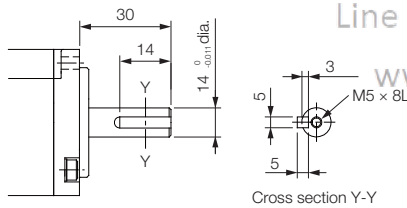

- With Two Flat Seats

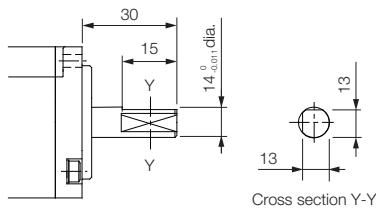

■ Specifications of Options

- Oil Seal

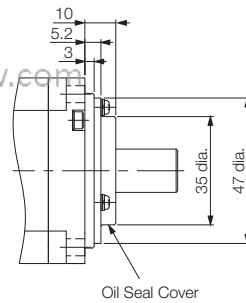

■ Connector Mounting Dimensions

- Cable Installed on Load Side

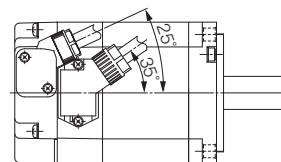

- Cable Installed on Non-load Side

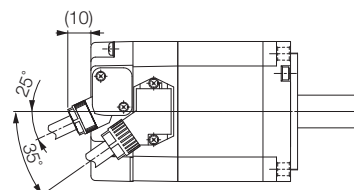

◆ SGM7A-08 and -10

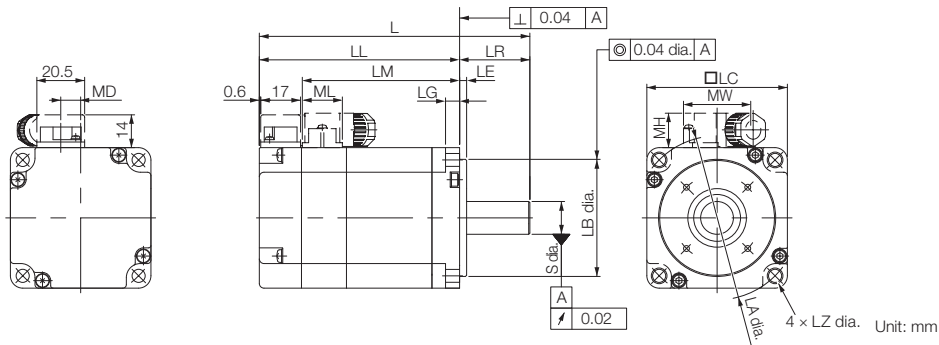

Model SGM7A-	L*	LL*	LM	Flange Dimensions						S	MD	MW	MH	ML	Approx. Mass* [kg]	
				LR	LE	LG	LC	LA	LB							LZ
08A□A2□	137 (184)	97 (144)	78.5	40	3	8	80	90	70 ⁰ _{-0.030}	7	19 ⁰ _{-0.013}	13.6	38	14.7	19.3	2.3 (2.9)
10A□A2□	162 (209)	122 (169)	103.5	40	3	8	80	90	70 ⁰ _{-0.030}	7	19 ⁰ _{-0.013}	13.6	38	14.7	19.3	3.1 (3.7)

* For models that have a batteryless absolute encoder, L and LL are 8 mm greater and the approximate mass is 0.1 kg greater than the given value. Refer to the following section for the values for individual models.

🔧 *Dimensions of Servomotors with Batteryless Absolute Encoders (page 64)*

Note: 1. The values in parentheses are for Servomotors with Holding Brakes.

2. The values for a straight, without key specification are given. Refer to the information given below for other shaft end specifications and option specifications.

■ Shaft End Specifications

- Straight with Key and Tap

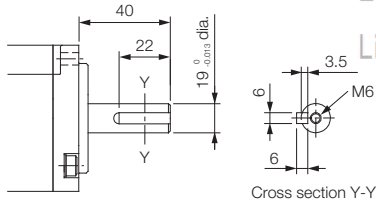

- With Two Flat Seats

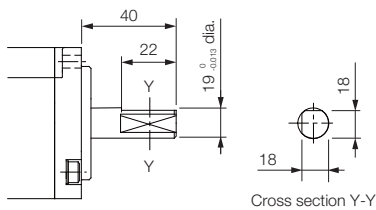

■ Specifications of Options

- Oil Seal

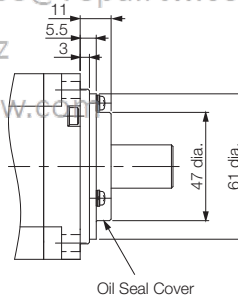

■ Connector Mounting Dimensions

- Cable Installed on Load Side

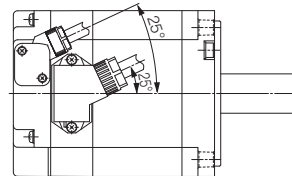

- Cable Installed on Non-load Side

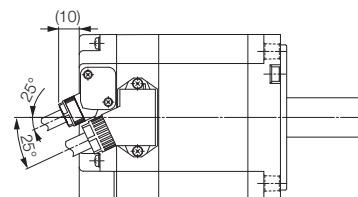

電話： 037-663333
Email: service@repairtw.com
Line id: @zzzz
www.repairtw.com

購、維修 此手冊零組件

Servomotors without Gears and without Holding Brakes

◆ SGM7A-15, -20, and -25

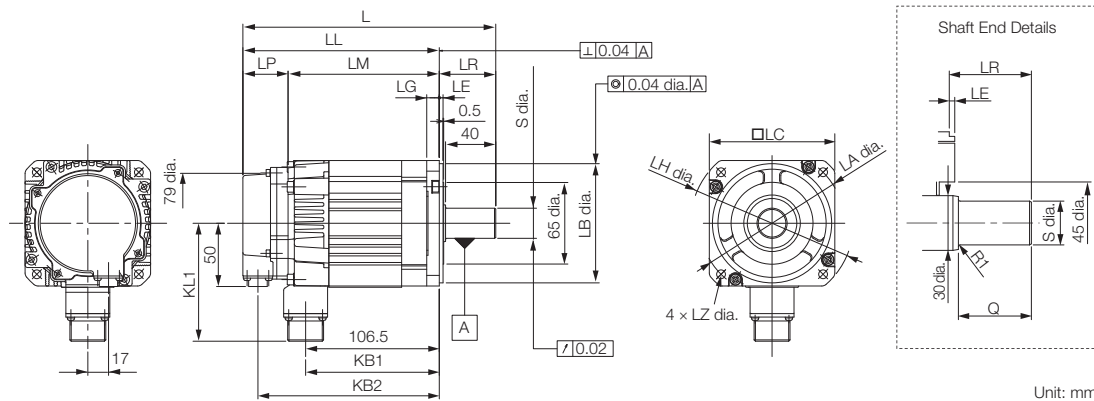

Model SGM7A-	L*	LL*	LM	LP*	LR	KB1	KB2*	KL1
15A□A21	202	157	121	36	45	107	145	94
20A□A21	218	173	137	36	45	123	161	94
25A□A21	241	196	160	36	45	146	184	94

Model SGM7A-	Flange Dimensions							Shaft End Dimensions		Approx. Mass [kg]
	LA	LB	LC	LE	LG	LH	LZ	S	Q	
15A□A21	115	95 ⁰ _{-0.035}	100	3	10	130	7	24 ⁰ _{-0.013}	40	4.6
20A□A21	115	95 ⁰ _{-0.035}	100	3	10	130	7	24 ⁰ _{-0.013}	40	5.4
25A□A21	115	95 ⁰ _{-0.035}	100	3	10	130	7	24 ⁰ _{-0.013}	40	6.8

* For models that have a batteryless absolute encoder, L, LL, LP, and KB2 are 8 mm greater than the given value. Refer to the following section for the values for individual models.

📖 **Dimensions of Servomotors with Batteryless Absolute Encoders (page 64)**

Note: 1. The values in parentheses are for Servomotors with Holding Brakes.

2. The values for a straight, without key specification are given. Refer to the information given below for other shaft end specifications and option specifications.

■ Shaft End Specifications

• Straight with Key and Tap

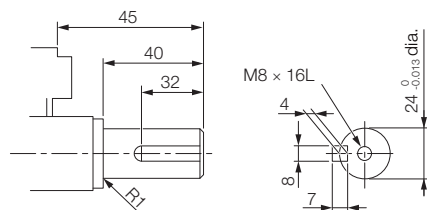

■ Connector Specifications

• Encoder Connector (24-bit Encoder)

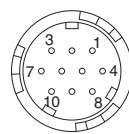

1	PS	6*	BAT(+)
2	/PS	7	-
3	-	8	-
4	PG5V	9	PG0V
5*	BAT(-)	10	FG (frame ground)

* A battery is required only for an absolute encoder.

Receptacle: CM10-R10P-D

Applicable plug: Not provided by Yaskawa.

Plug: CM10-AP10S-□-D for Right-angle Plug

CM10-SP10S-□-D for Straight Plug

(□ depends on the applicable cable size.)

Manufacturer: DDK Ltd.

• Servomotor Connector

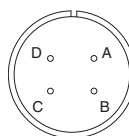

A	Phase U	C	Phase W
B	Phase V	D	FG (frame ground)

Manufacturer: DDK Ltd.

◆ SGM7A-30, -40, and -50

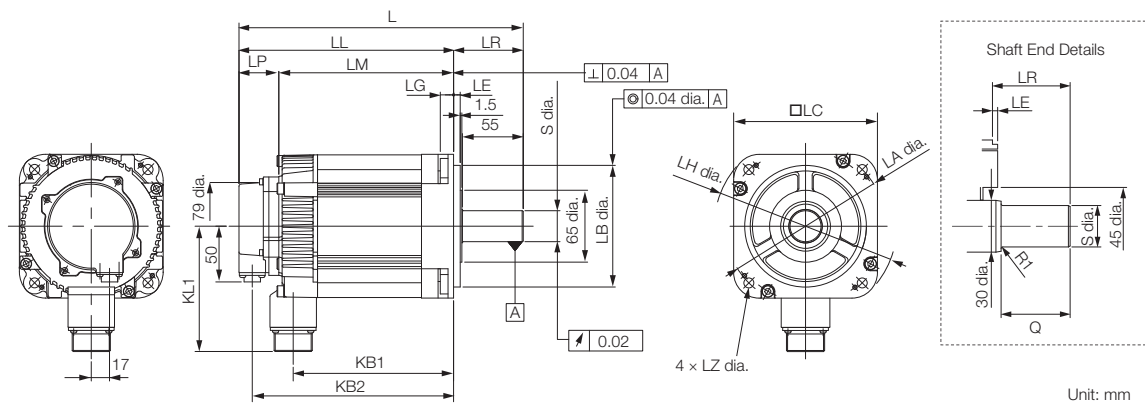

Model SGM7A-	L*	LL*	LM	LP*	LR	KB1	KB2*	KL1
30A□A21	257	194	158	36	63	145	182	114
40A□A21	296	233	197	36	63	184	221	114
50A□A21	336	273	237	36	63	224	261	114

Model SGM7A-	Flange Dimensions							Shaft End Dimensions		Approx. Mass [kg]
	LA	LB	LC	LE	LG	LH	LZ	S	Q	
30A□A21	145	110 ⁰ _{-0.035}	130	6	12	165	9	28 ⁰ _{-0.013}	55	10.5
40A□A21	145	110 ⁰ _{-0.035}	130	6	12	165	9	28 ⁰ _{-0.013}	55	13.5
50A□A21	145	110 ⁰ _{-0.035}	130	6	12	165	9	28 ⁰ _{-0.013}	55	16.5

* For models that have a batteryless absolute encoder, L, LL, LP, and KB2 are 8 mm greater than the given value. Refer to the following section for the values for individual models.

🔧 Dimensions of Servomotors with Batteryless Absolute Encoders (page 64)

Note: 1. The values in parentheses are for Servomotors with Holding Brakes.

2. The values for a straight, without key specification are given. Refer to the information given below for other shaft end specifications and option specifications.

■ Shaft End Specifications

- Straight with Key and Tap

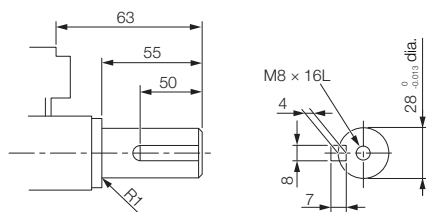

■ Connector Specifications

- Encoder Connector (24-bit Encoder)

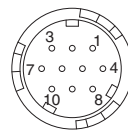

1	PS	6*	BAT(+)
2	/PS	7	-
3	-	8	-
4	PG5V	9	PG0V
5*	BAT(-)	10	FG (frame ground)

* A battery is required only for an absolute encoder.

Receptacle: CM10-R10P-D

Applicable plug: Not provided by Yaskawa.

Plug: CM10-AP10S-□-D for Right-angle Plug

CM10-SP10S-□-D for Straight Plug

(□ depends on the applicable cable size.)

Manufacturer: DDK Ltd.

- Servomotor Connector

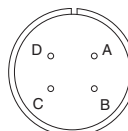

A	Phase U	C	Phase W
B	Phase V	D	FG (frame ground)

Manufacturer: DDK Ltd.

◆ SGM7A-70

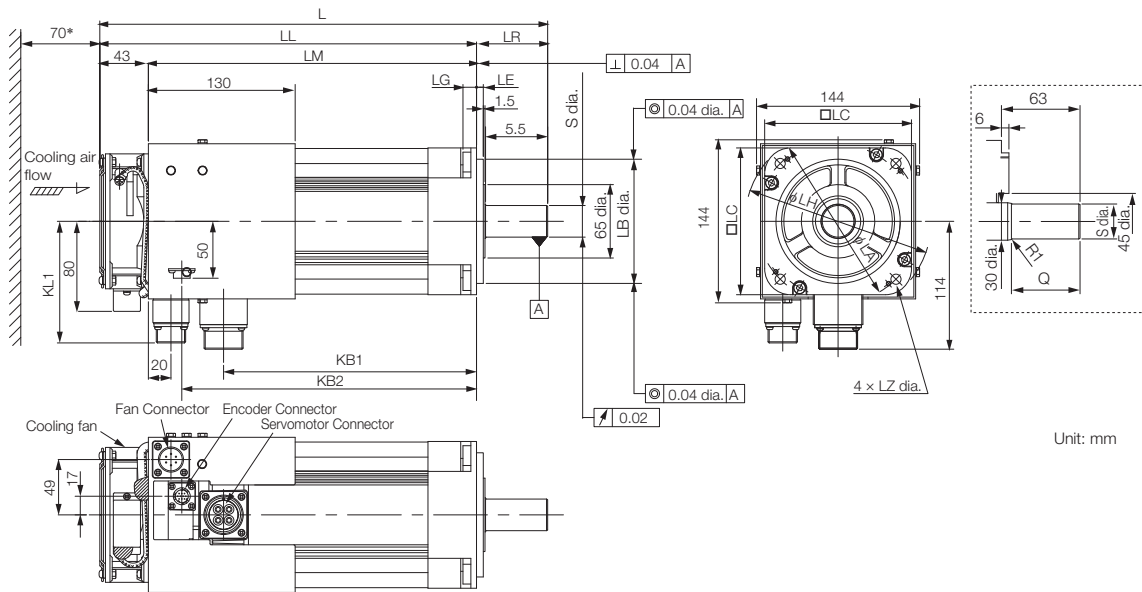

* Leave a minimum space of 70 mm around the Servomotor from walls and other equipment to allow for a sufficient amount of cooling air.

Model SGM7A-	L	LL	LM	LR	KB1	KB2*	KL1	Flange Dimensions							Shaft End Dimensions		Approx. Mass [kg]
								LA	LB	LC	LE	LG	LH	LZ	S	Q	
70A□A21	397	334	291	63	224	261	108	145	110 ⁰ _{-0.035}	130	6	12	165	9	28 ⁰ _{-0.013}	55	18.5

* For models that have a batteryless absolute encoder, KB is 8 mm greater than the given value. Refer to the following section for the values for individual models.

☞ **Dimensions of Servomotors with Batteryless Absolute Encoders** (page 64)

Note: 1. The values in parentheses are for Servomotors with Holding Brakes.

2. The values for a straight, without key specification are given. Refer to the information given below for other shaft end specifications and option specifications.

■ Cooling Fan Specifications

Single-phase, 220 V
50/60 Hz
17/15 W
0.11/0.09 A

■ Specifications of Fan Operation Error Detector

Contact Capacity

Maximum allowable voltage: 350 V (AC/DC)
Maximum allowable current: 120 mA (AC/DC)
Maximum controllable power: 360 mW

Alarm Contacts

ON for normal fan rotation.
OFF at 1,680 ± 100 min⁻¹ max.
OFF for 3 seconds at startup.

■ Shaft End Specifications

• Straight with Key and Tap

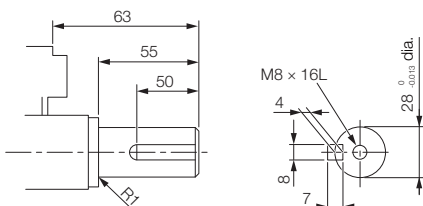

■ Connector Specifications

• Encoder Connector (24-bit Encoder)

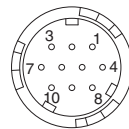

1	PS	6*	BAT(+)
2	/PS	7	-
3	-	8	-
4	PG5V	9	PG0V
5*	BAT(-)	10	FG (frame ground)

* A battery is required only for an absolute encoder.
Receptacle: CM10-R10P-D
Applicable plug: Not provided by Yaskawa.
Plug: CM10-AP10S-□-D for Right-angle Plug
CM10-SP10S-□-D for Straight Plug
(□ depends on the applicable cable size.)
Manufacturer: DDK Ltd.

• Servomotor Connector

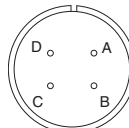

A	Phase U	C	Phase W
B	Phase V	D	FG (frame ground)

Manufacturer: DDK Ltd.

• Fan Connector

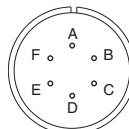

A	Fan motor	D	Alarm pin
B	Fan motor	E	Alarm pin
C	-	F	FG (frame ground)

Receptacle: MS3102A14S-6P
Applicable Plug (Available from Yaskawa Controls Co., Ltd.)
Plug: MS3108B14S-6S
Cable Clamp: MS3057-6A

Note: The Servomotor Connector (receptacle) is RoHS compliant. Contact the connector manufacturer for RoHS-compliant cable-side connectors (not provided by Yaskawa).

Servomotors without Gears and with Holding Brakes

◆ SGM7A-15 to -25

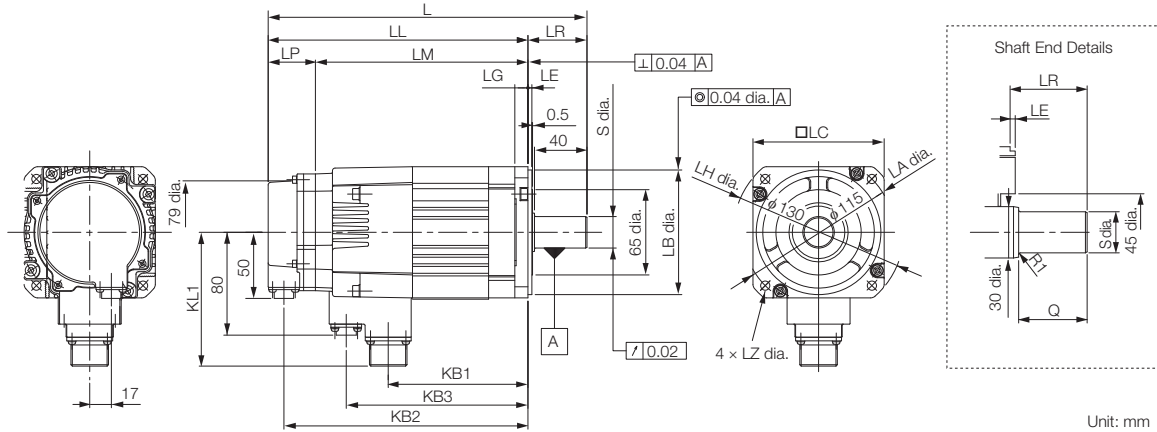

Unit: mm

Model SGM7A-	L*	LL*	LM	LP*	LR	KB1	KB2*	KB3	KL1
15A□A2C	243	198	162	36	45	107	186	139	102
20A□A2C	259	214	178	36	45	123	202	155	102
25A□A2C	292	247	211	36	45	156	235	188	102

Model SGM7A-	Flange Dimensions							Shaft End Dimensions		Approx. Mass [kg]
	LA	LB	LC	LE	LG	LH	LZ	S	Q	
15A□A2C	115	95 ⁰ _{-0.035}	100	3	10	130	7	24 ⁰ _{-0.013}	40	6.0
20A□A2C	115	95 ⁰ _{-0.035}	100	3	10	130	7	24 ⁰ _{-0.013}	40	6.8
25A□A2C	115	95 ⁰ _{-0.035}	100	3	10	130	7	24 ⁰ _{-0.013}	40	8.7

* For models that have a batteryless absolute encoder, L, LL, LP, and KB2 are 8 mm greater than the given value. Refer to the following section for the values for individual models.

Dimensions of Servomotors with Batteryless Absolute Encoders (page 64)

Note: 1. The values in parentheses are for Servomotors with Holding Brakes.

2. The values for a straight, without key specification are given. Refer to the information given below for other shaft end specifications and option specifications.

■ Shaft End Specifications

• Straight with Key and Tap

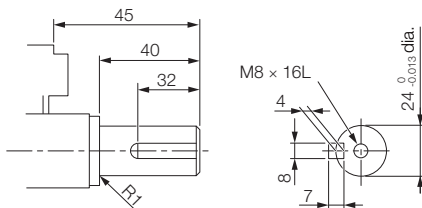

■ Connector Specifications

• Encoder Connector (24-bit Encoder)

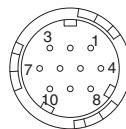

1	PS	6*	BAT(+)
2	/PS	7	-
3	-	8	-
4	PG5V	9	PG0V
5*	BAT(-)	10	FG (frame ground)

* A battery is required only for an absolute encoder.
Receptacle: CM10-R10P-D

Applicable plug: Not provided by Yaskawa.

Plug: CM10-AP10S-□-D for Right-angle Plug

CM10-SP10S-□-D for Straight Plug

(□ depends on the applicable cable size.)

Manufacturer: DDK Ltd.

• Servomotor Connector

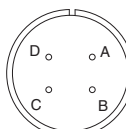

A	Phase U	C	Phase W
B	Phase V	D	FG (frame ground)

Manufacturer: DDK Ltd.

• Brake Connector

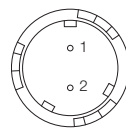

1	Brake terminal
2	Brake terminal

Note: There is no voltage polarity for the brake terminals.

Receptacle: CM10-R10P-D

Applicable plug: Not provided by Yaskawa.

Plug: CM10-AP2S-□-D for Right-angle Plug

CM10-SP2S-□-D for Straight Plug

(□ depends on the applicable cable size.)

Manufacturer: DDK Ltd.

◆ SGM7A-30 to -50

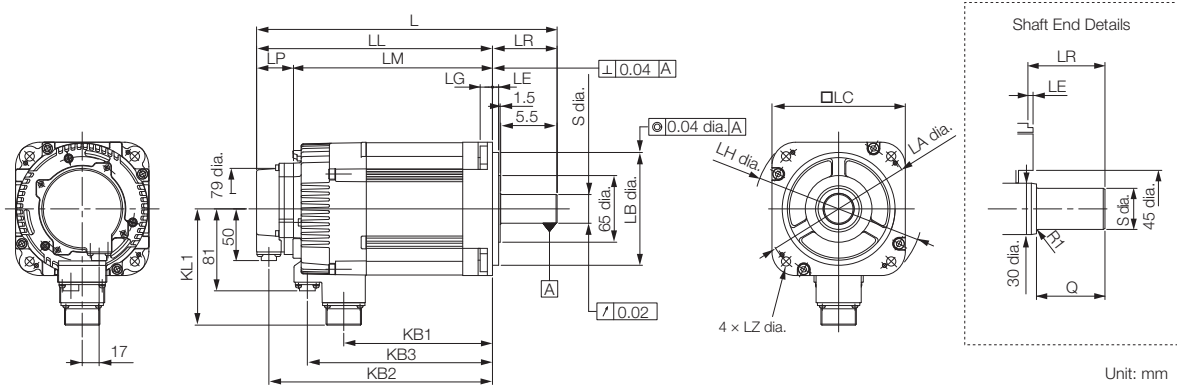

Model SGM7A-	L*	LL*	LM	LP*	LR	KB1	KB2*	KB3	KL1
30A□A2C	293	232	196	36	63	145	220	181	119
40A□A2C	332	269	233	36	63	184	257	220	119
50A□A2C	372	309	273	36	63	224	297	260	119

Model SGM7A-	Flange Dimensions							Shaft End Dimensions		Approx. Mass [kg]
	LA	LB	LC	LE	LG	LH	LZ	S	Q	
30A□A2C	145	110 ⁰ _{-0.035}	130	6	12	165	9	28 ⁰ _{-0.013}	55	13
40A□A2C	145	110 ⁰ _{-0.035}	130	6	12	165	9	28 ⁰ _{-0.013}	55	16
50A□A2C	145	110 ⁰ _{-0.035}	130	6	12	165	9	28 ⁰ _{-0.013}	55	19

* For models that have a batteryless absolute encoder, L, LL, LP, and KB2 are 8 mm greater than the given value. Refer to the following section for the values for individual models.

■ Dimensions of Servomotors with Batteryless Absolute Encoders (page 64)

Note: 1. The values in parentheses are for Servomotors with Holding Brakes.

2. The values for a straight, without key specification are given. Refer to the information given below for other shaft end specifications and option specifications.

■ Shaft End Specifications

- Straight with Key and Tap

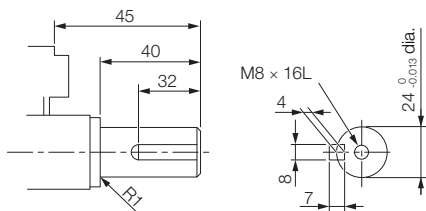

■ Connector Specifications

- Encoder Connector (24-bit Encoder)

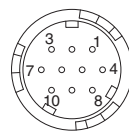

1	PS	6*	BAT(+)
2	/PS	7	-
3	-	8	-
4	PG5V	9	PG0V
5*	BAT(-)	10	FG (frame ground)

* A battery is required only for an absolute encoder.
Receptacle: CM10-R10P-D
Applicable plug: Not provided by Yaskawa.
Plug: CM10-AP10S-□-D for Right-angle Plug
CM10-SP10S-□-D for Straight Plug
(□ depends on the applicable cable size.)
Manufacturer: DDK Ltd.

- Servomotor Connector

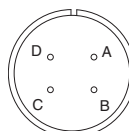

A	Phase U	C	Phase W
B	Phase V	D	FG (frame ground)

Manufacturer: DDK Ltd.

- Brake Connector

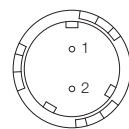

1	Brake terminal
2	Brake terminal

Note: There is no voltage polarity for the brake terminals.
Receptacle: CM10-R10P-D
Applicable plug: Not provided by Yaskawa.
Plug: CM10-AP2S-□-D for Right-angle Plug
CM10-SP2S-□-D for Straight Plug
(□ depends on the applicable cable size.)
Manufacturer: DDK Ltd.

Servomotors with Gears

◆ SGM7A-A5, -01, and -C2

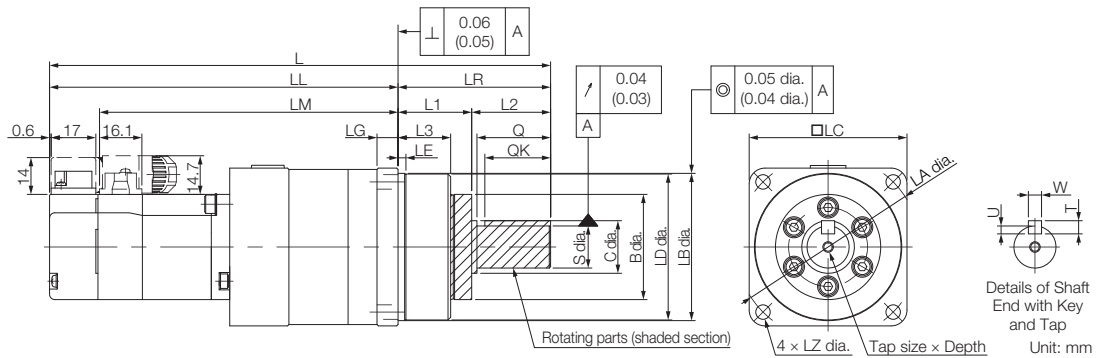

Model SGM7A-	Gear Ratio	L*	LL*	LM	Flange Dimensions										
					LR	LE	LG	B	LD	LB	LC	LA	LZ		
A5A□AH1□□	1/5	138	96	77.4	42	2.2	5	29	39.5	40 ⁰ _{-0.025}	40	46	3.4		
A5A□AH2□□	1/9	(178.5)	(136.5)												
A5A□AHC□□	1/21	147	105											(187.5)	(145.5)
A5A□AH7□□	1/33	178.5	120.5	101.9	58	2.5	8	40	55.5	56 ⁰ _{-0.030}	60	70	5.5		
01A□AH1□□	1/5	150	108	89.4	42	2.2	5	29	39.5	40 ⁰ _{-0.025}	40	46	3.4		
01A□AHB□□	1/11	190.5	132.5	113.9	58	2.5	8	40	55.5	56 ⁰ _{-0.030}	60	70	5.5		
01A□AHC□□	1/21	(231)	(173)												
01A□AH7□□	1/33	215	135											(255.5)	(175.5)
C2A□AH1□□	1/5	162	120	101.4	42	2.2	5	29	39.5	40 ⁰ _{-0.025}	40	46	3.4		
C2A□AHB□□	1/11	202.5	144.5	125.9	58	2.5	8	40	55.5	56 ⁰ _{-0.030}	60	70	5.5		
C2A□AHC□□	1/21	(275)	(195)												
C2A□AH7□□	1/33	227	147											(275)	(195)

Model SGM7A-	Flange Dimensions			Q	C	S	Tap Size × Depth	Key Dimensions				Approx. Mass [kg]
	L1	L2	L3					QK	U	W	T	
A5A□AH1□□	22	20	14.6	-	-	10 ⁰ _{-0.015}	M3 × 6L	15	2.5	4	4	0.6
A5A□AH2□□												0.7
A5A□AHC□□												(1.0)
A5A□AH7□□	28	30	20	28	20	16 ⁰ _{-0.018}	M4 × 8L	25	3	5	5	1.3
01A□AH1□□	22	20	14.6	-	-	10 ⁰ _{-0.015}	M3 × 6L	15	2.5	4	4	0.7
01A□AHB□□	28	30	20	28	20	16 ⁰ _{-0.018}	M4 × 8L	25	3	5	5	1.4
01A□AHC□□												(1.7)
01A□AH7□□	36	44	26	42	32	25 ⁰ _{-0.021}	M6 × 12L	36	4	8	7	2.8
C2A□AH1□□	22	20	14.6	-	-	10 ⁰ _{-0.015}	M3 × 6L	15	2.5	4	4	0.8
C2A□AHB□□	28	30	20	28	20	16 ⁰ _{-0.018}	M4 × 8L	25	3	5	5	1.5
C2A□AHC□□	36	44	26	42	32	25 ⁰ _{-0.021}	M6 × 12L	36	4	8	7	2.9
C2A□AH7□□												(3.2)

* For models that have a batteryless absolute encoder, L and LL are 8 mm greater than the given value. Refer to the following section for the values for individual models.

🔧 **Dimensions of Servomotors with Batteryless Absolute Encoders (page 64)**

Note: 1. The values in parentheses are for Servomotors with Holding Brakes.

2. Gear dimensions are different from those of the Σ, Σ-II, and Σ-III Series.

3. The values for the shaft end are for a straight shaft with key and tap. If a key and tap are not necessary, specify shaft end code 2 for the 8th digit.

■ Flange Output Face

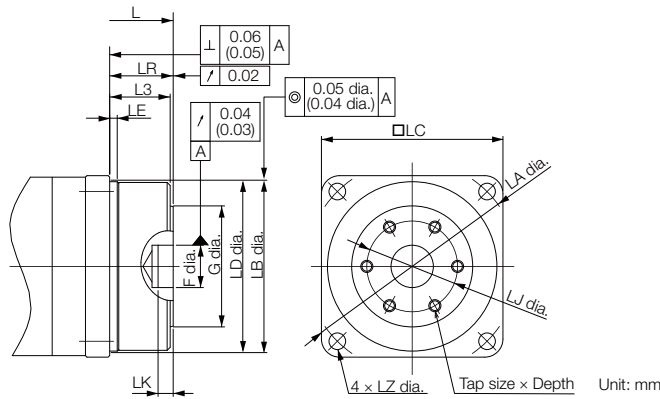

Note: The geometric tolerance in parentheses is the value for LC = 40.

Model SGM7A-	Gear Ratio	L*	LR	LJ	F	G	LK	No. of Taps × Tap Size × Depth	Approx. Mass [kg]
A5A□AH10□	1/5	111	15	18	5 ^{+0.012} ₀	24	3	3 × M4 × 6L	0.6 (0.9)
A5A□AH20□	1/9	(151.5)							
A5A□AHC0□	1/21	120 (160.5)							
A5A□AH70□	1/33	141.5 (182)	21	30	14 ^{+0.018} ₀	40	5	6 × M4 × 7L	1.2 (1.5)
01A□AH10□	1/5	123 (163.5)	15	18	5 ^{+0.012} ₀	24	3	3 × M4 × 6L	0.7 (1.0)
01A□AHB0□	1/11	153.5 (194)	21	30	14 ^{+0.018} ₀	40	5	3 × M4 × 7L	1.3 (1.6)
01A□AHC0□	1/21	(194)							
01A□AH70□	1/33	162 (202.5)	27	45	24 ^{+0.021} ₀	59		6 × M6 × 10L	2.4 (2.7)
C2A□AH10□	1/5	135 (183)	15	18	5 ^{+0.012} ₀	24	3	3 × M4 × 6L	0.8 (1.1)
C2A□AHB0□	1/11	165.5 (213.5)	21	30	14 ^{+0.018} ₀	40	5	6 × M4 × 7L	1.4 (1.7)
C2A□AHC0□	1/21	174 (222)	27	45	24 ^{+0.021} ₀	59	5	6 × M6 × 10L	2.5 (2.8)
C2A□AH70□	1/33	(222)							

* For models that have a batteryless absolute encoder, L is 8 mm greater than the given value. Refer to the following section for the values for individual models.

📖 **Dimensions of Servomotors with Batteryless Absolute Encoders (page 64)**

Note: 1. The values in parentheses are for Servomotors with Holding Brakes.

2. Dimensions not found in the above table are the same as those in the table on the previous page.



Important

For a Servomotor with a flange output that has square gear flange dimensions (□LC) of 40 mm, we recommend that you design the Servomotor with the dimensions shown in the following figure in order to secure a gap between the gear oil seal and the connecting parts on the load side.

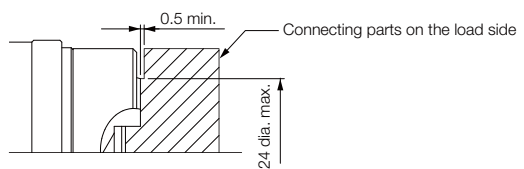

◆ SGM7A-02, -04, and -06

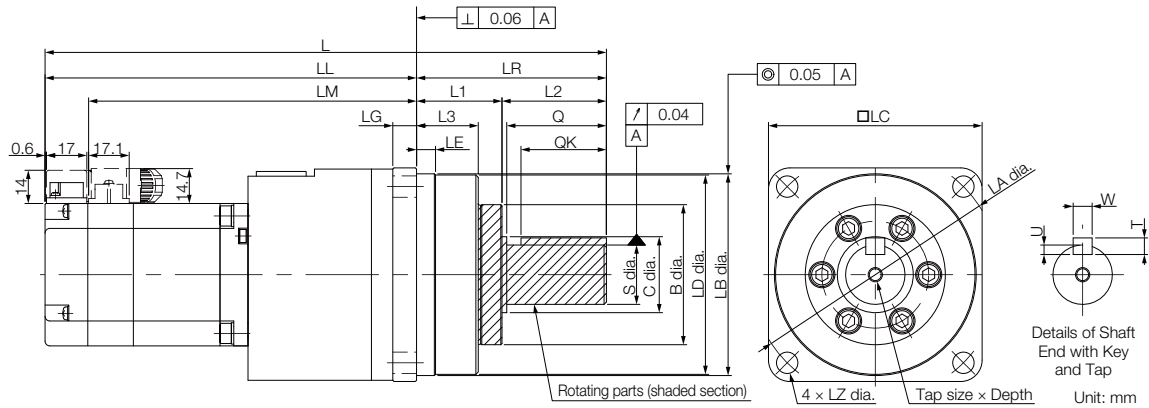

Model SGM7A-	Gear Ratio	L*	LL*	LM	Flange Dimensions								
					LR	LE	LG	B	LD	LB	LC	LA	LZ
02A□AH1□□	1/5	191.5 (232)	133.5 (174)	115.2	58	2.5	8	40	55.5	56 ⁰ _{-0.030}	60	70	5.5
02A□AHB□□	1/11												
02A□AHC□□	1/21	220.5 (261)	140.5 (181)	122.2	80	7.5	10	59	84	85 ⁰ _{-0.035}	90	105	9
02A□AH7□□	1/33												
04A□AH1□□	1/5	207.5 (248)	149.5 (190)	131.2	58	2.5	8	40	55.5	56 ⁰ _{-0.030}	60	70	5.5
04A□AHB□□	1/11	236.5 (277)	156.5 (197)	138.2	80	7.5	10	59	84	85 ⁰ _{-0.035}	90	105	9
04A□AHC□□	1/21												
04A□AH7□□	1/33	322.5 (363)	189.5 (230)	171.2	133	12.5	13	84	114	115 ⁰ _{-0.035}	120	135	11
06A□AH1□□	1/5	258.5 (312.5)	178.5 (232.5)	160.2	80	7.5	10	59	84	85 ⁰ _{-0.035}	90	105	9
06A□AHB□□	1/11												
06A□AHC□□	1/21	344.5 (398.5)	211.5 (265.5)	193.2	133	12.5	13	84	114	115 ⁰ _{-0.035}	120	135	11
06A□AH7□□	1/33												

Model SGM7A-	Flange Dimensions						Tap Size × Depth	Key Dimensions				Approx. Mass [kg]
	L1	L2	L3	Q	C	S		QK	U	W	T	
02A□AH1□□	28	30	20	28	20	16 ⁰ _{-0.018}	M4 × 8L	25	3	5	5	1.8 (2.4)
02A□AHB□□												1.9 (2.5)
02A□AHC□□	36	44	26	42	32	25 ⁰ _{-0.021}	M6 × 12L	36	4	8	7	3.7 (4.3)
02A□AH7□□												
04A□AH1□□	36	44	26	42	32	25 ⁰ _{-0.021}	M6 × 12L	36	4	8	7	2.1 (2.7)
04A□AHB□□												4.0 (4.6)
04A□AHC□□	48	85	33	82	44	40 ⁰ _{-0.025}	M10 × 20L	70	5	12	8	8.6 (9.2)
04A□AH7□□												
06A□AH1□□	36	44	26	42	32	25 ⁰ _{-0.021}	M6 × 12L	36	4	8	7	4.3 (4.9)
06A□AHB□□												4.5 (5.1)
06A□AHC□□	48	85	33	82	44	40 ⁰ _{-0.025}	M10 × 20L	70	5	12	8	9.1 (9.7)
06A□AH7□□												

* For models that have a batteryless absolute encoder, L and LL are 8 mm greater than the given value. Refer to the following section for the values for individual models.

📐 Dimensions of Servomotors with Batteryless Absolute Encoders (page 64)

- Note: 1. The values in parentheses are for Servomotors with Holding Brakes.
 2. Gear dimensions are different from those of the Σ, Σ-II, and Σ-III Series.
 3. The values for the shaft end are for a straight shaft with key and tap. If a key and tap are not necessary, specify shaft end code 2 for the 8th digit.

■ Flange Output Face

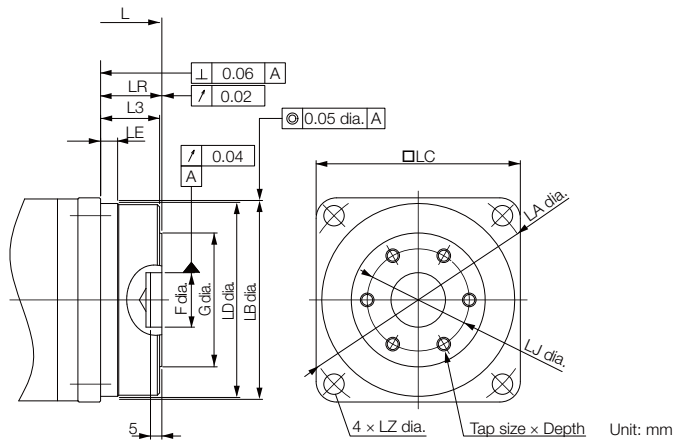

Model SGM7A-	Gear Ratio	L*	LR	LJ	F	G	No. of Taps × Tap Size × Depth	Approx. Mass [kg]
02A□AH10□	1/5	154.5 (195)	21	30	14 ^{+0.018} ₀	40	6 × M4 × 7L	1.7 (2.3)
02A□AB20□	1/11							1.8 (2.4)
02A□AHC0□	1/21	167.5 (208)	27	45	24 ^{+0.021} ₀	59	6 × M6 × 10L	3.3 (3.9)
02A□AH70□	1/33							
04A□AH10□	1/5	170.5 (211)	21	30	14 ^{+0.018} ₀	40	6 × M4 × 7L	2.0 (2.6)
04A□AHB0□	1/11	183.5 (224)	27	45	24 ^{+0.021} ₀	59	6 × M6 × 10L	3.6 (4.2)
04A□AHC0□	1/21							
04A□AH70□	1/33	224.5 (265)	35	60	32 ^{+0.025} ₀	84	6 × M8 × 12L	7.2 (7.8)
06A□AH10□	1/5	205.5 (259.5)	27	45	24 ^{+0.021} ₀	59	6 × M6 × 10L	3.9 (4.5)
06A□AHB0□	1/11							4.1 (4.7)
06A□AHC0□	1/21	246.5 (300.5)	35	60	32 ^{+0.025} ₀	84	6 × M8 × 12L	7.7 (8.3)
06A□AH70□	1/33							

* For models that have a batteryless absolute encoder, L is 8 mm greater than the given value. Refer to the following section for the values for individual models.

📖 **Dimensions of Servomotors with Batteryless Absolute Encoders (page 64)**

Note: 1. The values in parentheses are for Servomotors with Holding Brakes.

2. Dimensions not found in the above table are the same as those in the table on the previous page.

◆ SGM7A-08 and -10

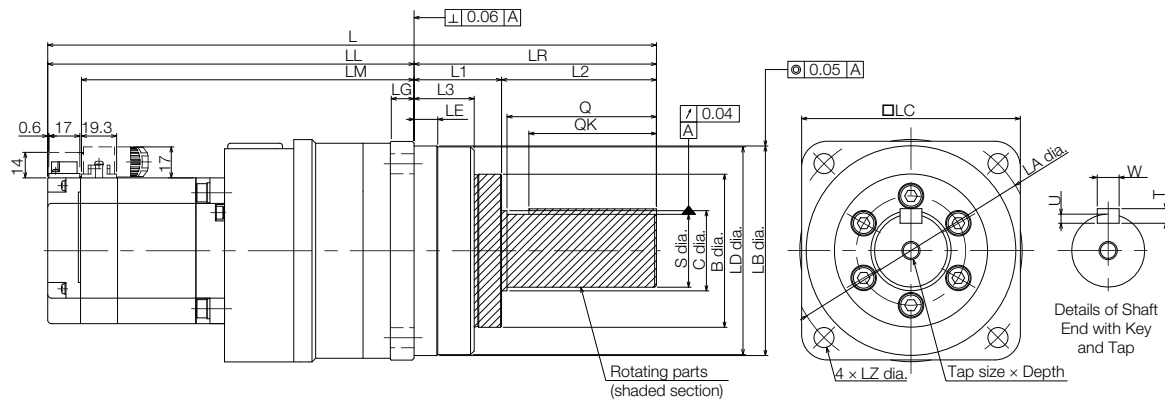

Unit: mm

Model SGM7A-	Gear Ratio	L*	LL*	LM	Flange Dimensions								
					LR	LE	LG	B	LD	LB	LC	LA	LZ
08A□AH1□□	1/5	255	175	156.5	80	7.5	10	59	84	85 ⁰ _{-0.035}	90	105	9
08A□AHB□□	1/11	(302)	(222)										
08A□AHC□□	1/21	334	201	182.5	133	12.5	13	84	114	115 ⁰ _{-0.035}	120	135	11
08A□AH7□□	1/33	(381)	(248)										
10A□AH1□□	1/5	280	200	181.5	80	7.5	10	59	84	85 ⁰ _{-0.035}	90	105	9
10A□AHB□□	1/11	(327)	(247)										
10A□AHC□□	1/21	359	226	207.5	133	12.5	13	84	114	115 ⁰ _{-0.035}	120	135	11
10A□AH7□□	1/33	(406)	(273)										

Model SGM7A-	Flange Dimensions			Q	C	S	Tap Size x Depth	Key Dimensions				Approx. Mass* [kg]
	L1	L2	L3					QK	U	W	T	
08A□AH1□□	36	44	26	42	32	25 ⁰ _{-0.021}	M6 x 12L	36	4	8	7	4.9 (5.8)
08A□AHB□□												5.1 (6.0)
08A□AHC□□	48	85	33	82	44	40 ⁰ _{-0.025}	M10 x 20L	70	5	12	8	9.8 (10.7)
08A□AH7□□												
10A□AH1□□	36	44	26	42	32	25 ⁰ _{-0.021}	M6 x 12L	36	4	8	7	6.0 (6.6)
10A□AHB□□												
10A□AHC□□	48	85	33	82	44	40 ⁰ _{-0.025}	M10 x 20L	70	5	12	8	10.9 (11.5)
10A□AH7□□												

* For models that have a batteryless absolute encoder, L and LL are 8 mm greater and the approximate mass is 0.1 kg greater than the given value. Refer to the following section for the values for individual models.

☞ Dimensions of Servomotors with Batteryless Absolute Encoders (page 64)

Note: 1. The values in parentheses are for Servomotors with Holding Brakes.

2. Gear dimensions are different from those of the Σ, Σ-II, and Σ-III Series.

3. The values for the shaft end are for a straight shaft with key and tap. If a key and tap are not necessary, specify shaft end code 2 for the 8th digit.

■ Flange Output Face

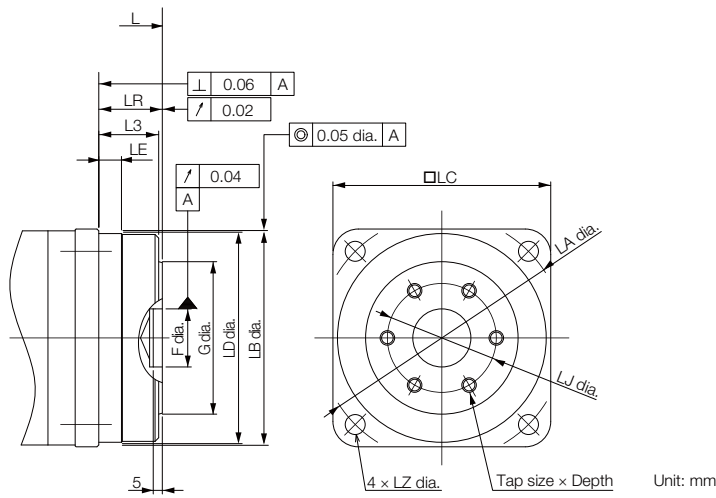

Model SGM7A-	Gear Ratio	L*	LR	LJ	F	G	No. of Taps × Tap Size × Depth	Approx. Mass* [kg]
08A□AH10□	1/5	202 (249)	27	45	24 ^{+0.021} ₀	59	6 × M6 × 10L	4.7 (5.3)
08A□AHB0□	1/11							4.9 (5.5)
08A□AHC0□	1/21	236 (283)	35	60	32 ^{+0.025} ₀	84	6 × M8 × 12L	8.6 (9.2)
08A□AH70□	1/33							8.6 (9.2)
10A□AH10□	1/5	227 (274)	27	45	24 ^{+0.021} ₀	59	6 × M6 × 10L	5.6 (6.3)
10A□AHB0□	1/11							5.6 (6.3)
10A□AHC0□	1/21	261 (308)	35	60	32 ^{+0.025} ₀	84	6 × M8 × 12L	9.5 (10.1)
10A□AH70□	1/33							9.5 (10.1)

* For models that have a batteryless absolute encoder, L is 8 mm greater and the approximate mass is 0.1 kg greater than the given value. Refer to the following section for the values for individual models.

🔧 **Dimensions of Servomotors with Batteryless Absolute Encoders (page 64)**

Note: 1. The values in parentheses are for Servomotors with Holding Brakes.

2. Dimensions not found in the above table are the same as those in the table on the previous page.

Dimensions of Servomotors with Batteryless Absolute Encoders

◆ Servomotors without Gears

Model SGM7A-	L	LL	LP	KB2	Approx. Mass [kg]
A5A6A2□	89.5 (130)	64.5 (105)	-	-	0.3 (0.6)
01A6A2□	101.5 (142)	76.5 (117)	-	-	0.4 (0.7)
C2A6A2□	113.5 (161.5)	88.5 (136.5)	-	-	0.5 (0.8)
02A6A2□	107.5 (148)	77.5 (118)	-	-	0.8 (1.4)
04A6A2□	123.5 (164)	93.5 (134)	-	-	1.2 (1.8)
06A6A2□	145.5 (198.5)	115.5 (169.5)	-	-	1.6 (2.2)
08A6A2□	145 (192)	105 (152)	-	-	2.4 (3.0)
10A6A2□	170 (217)	130 (177)	-	-	3.2 (3.8)
15A6A2□	210 (251)	165 (206)	44 (44)	153 (194)	4.6 (6.0)
20A6A2□	226 (267)	181 (222)	44 (44)	169 (210)	5.4 (6.8)
25A6A2□	249 (300)	204 (255)	44 (44)	192 (243)	6.8 (8.7)
30A6A2□	265 (301)	202 (240)	44 (44)	190 (228)	10.5 (13)
40A6A2□	304 (340)	241 (277)	44 (44)	229 (265)	13.5 (16)
50A6A2□	344 (380)	281 (317)	44 (44)	269 (305)	16.5 (19)
70A6A2□	397	334		269	18.5

Note: The values in parentheses are for Servomotors with Holding Brakes.

Line id: @zzzz

www.repairtw.com

◆ Servomotors with Gears

• Shaft End Specification: Straight

Model SGM7A-	L	LL	Approx. Mass [kg]
A5A6AH1□□	146	104	0.6
A5A6AH2□□	(186.5)	(144.5)	(0.9)
A5A6AHC□□	155	113	0.7
	(195.5)	(153.5)	(1.7)
A5A6AH7□□	186.5	128.5	1.3
	(227)	(169)	(1.6)
01A6AH1□□	158	116	0.7
	(198.5)	(156.5)	(1.0)
01A6AHB□□	198.5	140.5	1.4
01A6AHC□□	(239)	(181)	(1.7)
01A6AH7□□	223	143	2.8
	(263.5)	(183.5)	(3.1)
C2A6AH1□□	170	128	0.8
	(218)	(176)	(1.1)
C2A6AHB□□	210.5	152.5	1.5
	(258.5)	(200.5)	(1.8)
C2A6AHC□□	235	155	2.9
C2A6AH7□□	(283)	(203)	(3.2)
02A6AH1□□	191.5	141.5	1.8
	(232)	(182.5)	(2.4)
02A6AHB□□			1.9
			(2.5)
02A6AHC□□	228.5	148.5	3.7
02A6AH7□□	(269)	(189)	(4.3)
04A6AH1□□	207.5	149.5	2.1
	(248)	(198)	(2.7)
04A6AHB□□	236.5	184.5	4.0
04A6AHC□□	(285)	(205)	(4.6)
04A6AH7□□	330.5	197.5	8.6
	(371)	(238)	(9.2)
06A6AH1□□			4.3
	266.5	186.5	(4.9)
06A6AHB□□	(320.5)	(240.5)	4.5
			(5.1)
06A6AHC□□	352.5	219.5	9.1
06A6AH7□□	(406.5)	(273.5)	(9.7)
08A6AH1□□			5.0
	263	183	(5.9)
08A6AHB□□	(310)	(230)	5.2
			(6.1)
08A6AHC□□	342	209	9.9
08A6AH7□□	(389)	(256)	(10.8)
10A6AH1□□	288	208	6.1
	(335)	(255)	(6.7)
10A6AHB□□			11.0
10A6AHC□□	367	234	(11.6)
10A6AH7□□	(414)	(281)	

• Shaft End Specification: Flange Output

Model SGM7A-	L	Approx. Mass [kg]
A5A6AH10□	119	0.6
A5A6AH20□	(159.5)	(0.9)
A5A6AHC0□	128	
	(168.5)	
A5A6AH70□	149.5	1.2
	(190)	(1.5)
01A6AH10□	131	0.7
	(171.5)	(1.0)
01A6AHB0□	161.5	1.3
01A6AHC0□	(202)	(1.6)
01A6AH70□	170	2.4
	(210.5)	(2.7)
C2A6AH10□	143	0.8
	(191)	(1.1)
C2A6AHB0□	173.5	1.4
	(221.5)	(1.7)
C2A6AHC0□	210.5	2.5
C2A6AH70□	(258.5)	(2.8)
02A6AH10□		1.7
	162.5	(2.3)
02A6AHB0□	(203)	1.8
		(2.4)
02A6AHC0□	175.5	3.3
02A6AH70□	(216)	(3.9)
04A6AH10□	178.5	2.0
	(219)	(2.6)
04A6AHB0□	191.5	3.6
04A6AHC0□	(232)	(4.2)
04A6AH70□	232.5	7.2
	(273)	(7.8)
06A6AH10□		3.9
	213.5	(4.5)
06A6AHB0□	(267.5)	4.1
		(4.7)
06A6AHC0□	254.5	7.7
06A6AH70□	(308.5)	(8.3)
08A6AH10□		4.8
	210	(5.4)
08A6AHB0□	(257)	5.0
		(5.6)
08A6AHC0□	244	8.7
08A6AH70□	(291)	(9.3)
10A6AH10□	235	5.7
	(282)	(6.4)
10A6AHB0□		9.6
10A6AHC0□	269	(10.2)
10A6AH70□	(316)	

Note: The values in parentheses are for Servomotors with Holding Brakes.

Selecting Cables

◆ Cable Configurations

The cables shown below are required to connect a Servomotor to a SERVOPACK.

Encoder Cable of 20 m or Less

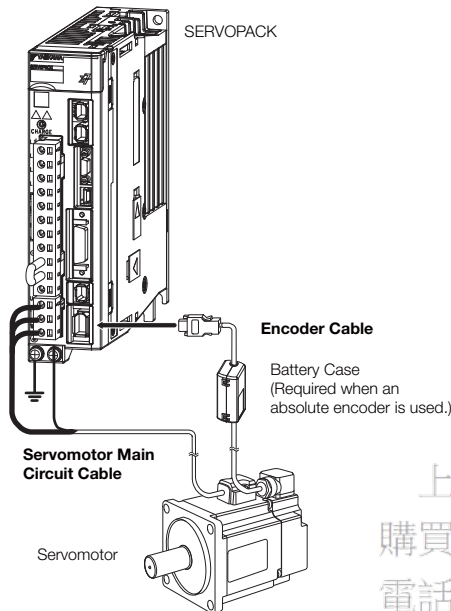

Encoder Cable of 30 m to 50 m (Relay Cable)

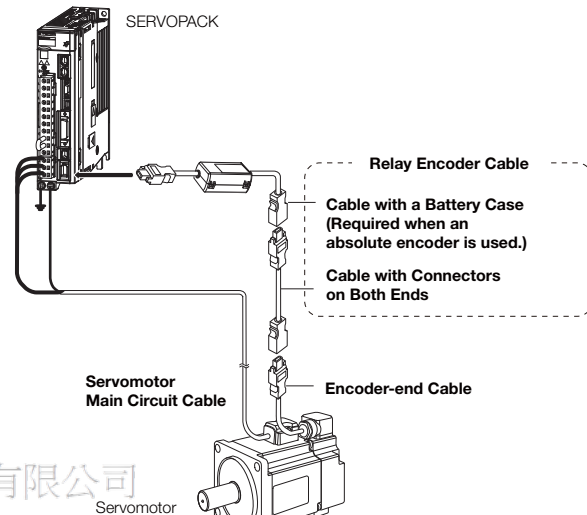

上正科技有限公司
購買、維修 此手冊零組件
電話： 037-466333

- Note: 1. Cables with connectors on both ends that are compliant with an IP67 protective structure and European Safety Standards are not available from Yaskawa for the SGM7A-15A to SGM7A-70A Servomotors. You must make such a cable yourself. Use the Connectors specified by Yaskawa for these Servomotors. (These Connectors are compliant with the standards.) Yaskawa does not specify what wiring materials to use.
2. If the Encoder Cable length exceeds 20 m, be sure to use a Relay Encoder Cable.
3. If you use a Servomotor Main Circuit Cable that exceeds 20 m, the intermittent duty zone in the torque-motor speed characteristics will become smaller because the voltage drop increases.
4. Refer to the following manual for the following information.
- Cable dimensional drawings and cable connection specifications
 - Order numbers and specifications of individual connectors for cables
 - Order numbers and specifications for wiring materials
- 📖 *Σ-7-Series AC Servo Drive Peripheral Device Selection Manual (Manual No.: SIEP S80001 32)*



Important

For the SGM7A-A5 to -10, there are different order numbers for the Servomotor Main Circuit Cables and Encoder Cables depending on the cable installation direction. Confirm the order numbers before you order.

Cable Installed toward Load

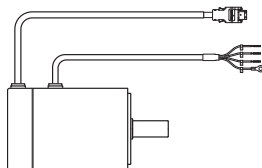

Cable Installed away from Load

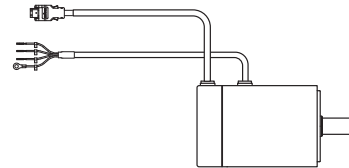

◆ Servomotor Main Circuit Cables

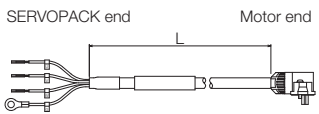
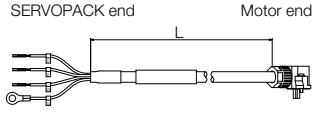
Servomotor Model	Name	Length (L)	Order Number		Appearance
			Standard Cable	Flexible Cable*	
SGM7A-A5 to -C2 50 W to 150 W	For Servo- motors with- out Holding Brakes Cable installed toward load	3 m	JZSP-C7M10F-03-E	JZSP-C7M12F-03-E	
		5 m	JZSP-C7M10F-05-E	JZSP-C7M12F-05-E	
		10 m	JZSP-C7M10F-10-E	JZSP-C7M12F-10-E	
		15 m	JZSP-C7M10F-15-E	JZSP-C7M12F-15-E	
		20 m	JZSP-C7M10F-20-E	JZSP-C7M12F-20-E	
		30 m	JZSP-C7M10F-30-E	JZSP-C7M12F-30-E	
		40 m	JZSP-C7M10F-40-E	JZSP-C7M12F-40-E	
50 m		JZSP-C7M10F-50-E	JZSP-C7M12F-50-E		
SGM7A-02 to -06 200 W to 600 W		3 m	JZSP-C7M20F-03-E	JZSP-C7M22F-03-E	
		5 m	JZSP-C7M20F-05-E	JZSP-C7M22F-05-E	
		10 m	JZSP-C7M20F-10-E	JZSP-C7M22F-10-E	
		15 m	JZSP-C7M20F-15-E	JZSP-C7M22F-15-E	
		20 m	JZSP-C7M20F-20-E	JZSP-C7M22F-20-E	
		30 m	JZSP-C7M20F-30-E	JZSP-C7M22F-30-E	
	40 m	JZSP-C7M20F-40-E	JZSP-C7M22F-40-E		
SGM7A-08 and -10 750 W, 1.0 kW	3 m	JZSP-C7M30F-03-E	JZSP-C7M32F-03-E		
	5 m	JZSP-C7M30F-05-E	JZSP-C7M32F-05-E		
	10 m	JZSP-C7M30F-10-E	JZSP-C7M32F-10-E		
	15 m	JZSP-C7M30F-15-E	JZSP-C7M32F-15-E		
	20 m	JZSP-C7M30F-20-E	JZSP-C7M32F-20-E		
	30 m	JZSP-C7M30F-30-E	JZSP-C7M32F-30-E		
	40 m	JZSP-C7M30F-40-E	JZSP-C7M32F-40-E		
SGM7A-A5 to -C2 50 W to 150 W	For Servo- motors with- out Holding Brakes Cable installed away from load	3 m	JZSP-C7M10G-03-E	JZSP-C7M12G-03-E	
		5 m	JZSP-C7M10G-05-E	JZSP-C7M12G-05-E	
		10 m	JZSP-C7M10G-10-E	JZSP-C7M12G-10-E	
		15 m	JZSP-C7M10G-15-E	JZSP-C7M12G-15-E	
		20 m	JZSP-C7M10G-20-E	JZSP-C7M12G-20-E	
		30 m	JZSP-C7M10G-30-E	JZSP-C7M12G-30-E	
		40 m	JZSP-C7M10G-40-E	JZSP-C7M12G-40-E	
50 m		JZSP-C7M10G-50-E	JZSP-C7M12G-50-E		
SGM7A-02 to -06 200 W to 600 W		3 m	JZSP-C7M20G-03-E	JZSP-C7M22G-03-E	
		5 m	JZSP-C7M20G-05-E	JZSP-C7M22G-05-E	
		10 m	JZSP-C7M20G-10-E	JZSP-C7M22G-10-E	
		15 m	JZSP-C7M20G-15-E	JZSP-C7M22G-15-E	
		20 m	JZSP-C7M20G-20-E	JZSP-C7M22G-20-E	
		30 m	JZSP-C7M20G-30-E	JZSP-C7M22G-30-E	
	40 m	JZSP-C7M20G-40-E	JZSP-C7M22G-40-E		
SGM7A-08 and -10 750 W, 1.0 kW	3 m	JZSP-C7M30G-03-E	JZSP-C7M32G-03-E		
	5 m	JZSP-C7M30G-05-E	JZSP-C7M32G-05-E		
	10 m	JZSP-C7M30G-10-E	JZSP-C7M32G-10-E		
	15 m	JZSP-C7M30G-15-E	JZSP-C7M32G-15-E		
	20 m	JZSP-C7M30G-20-E	JZSP-C7M32G-20-E		
	30 m	JZSP-C7M30G-30-E	JZSP-C7M32G-30-E		
	40 m	JZSP-C7M30G-40-E	JZSP-C7M32G-40-E		
50 m	JZSP-C7M30G-50-E	JZSP-C7M32G-50-E			

* Use Flexible Cables for moving parts of machines, such as robots. The recommended bending radius (R) is 90 mm or larger.

Rotary Servomotors
SGM7A

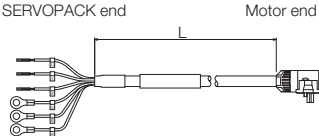
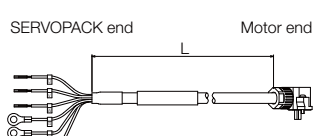
Servomotor Model	Name	Length (L)	Order Number		Appearance
			Standard Cable	Flexible Cable*	
SGM7A-A5 to -C2 50 W to 150 W		3 m	JZSP-C7M13F-03-E	JZSP-C7M14F-03-E	
		5 m	JZSP-C7M13F-05-E	JZSP-C7M14F-05-E	
		10 m	JZSP-C7M13F-10-E	JZSP-C7M14F-10-E	
		15 m	JZSP-C7M13F-15-E	JZSP-C7M14F-15-E	
		20 m	JZSP-C7M13F-20-E	JZSP-C7M14F-20-E	
		30 m	JZSP-C7M13F-30-E	JZSP-C7M14F-30-E	
		40 m	JZSP-C7M13F-40-E	JZSP-C7M14F-40-E	
		50 m	JZSP-C7M13F-50-E	JZSP-C7M14F-50-E	
SGM7A-02 to -06 200 W to 600 W	For Servo-motors with Holding Brakes Cable installed toward load	3 m	JZSP-C7M23F-03-E	JZSP-C7M24F-03-E	
		5 m	JZSP-C7M23F-05-E	JZSP-C7M24F-05-E	
		10 m	JZSP-C7M23F-10-E	JZSP-C7M24F-10-E	
		15 m	JZSP-C7M23F-15-E	JZSP-C7M24F-15-E	
		20 m	JZSP-C7M23F-20-E	JZSP-C7M24F-20-E	
		30 m	JZSP-C7M23F-30-E	JZSP-C7M24F-30-E	
		40 m	JZSP-C7M23F-40-E	JZSP-C7M24F-40-E	
		50 m	JZSP-C7M23F-50-E	JZSP-C7M24F-50-E	
SGM7A-08 and -10 750 W, 1.0 kW		3 m	JZSP-C7M33F-03-E	JZSP-C7M34F-03-E	
		5 m	JZSP-C7M33F-05-E	JZSP-C7M34F-05-E	
		10 m	JZSP-C7M33F-10-E	JZSP-C7M34F-10-E	
		15 m	JZSP-C7M33F-15-E	JZSP-C7M34F-15-E	
		20 m	JZSP-C7M33F-20-E	JZSP-C7M34F-20-E	
		30 m	JZSP-C7M33F-30-E	JZSP-C7M34F-30-E	
		40 m	JZSP-C7M33F-40-E	JZSP-C7M34F-40-E	
		50 m	JZSP-C7M33F-50-E	JZSP-C7M34F-50-E	
SGM7A-A5 to -C2 50 W to 150 W		3 m	JZSP-C7M13G-03-E	JZSP-C7M14G-03-E	
		5 m	JZSP-C7M13G-05-E	JZSP-C7M14G-05-E	
		10 m	JZSP-C7M13G-10-E	JZSP-C7M14G-10-E	
		15 m	JZSP-C7M13G-15-E	JZSP-C7M14G-15-E	
		20 m	JZSP-C7M13G-20-E	JZSP-C7M14G-20-E	
		30 m	JZSP-C7M13G-30-E	JZSP-C7M14G-30-E	
		40 m	JZSP-C7M13G-40-E	JZSP-C7M14G-40-E	
		50 m	JZSP-C7M13G-50-E	JZSP-C7M14G-50-E	
SGM7A-02 to -06 200 W to 600 W	For Servo-motors with Holding Brakes Cable installed away from load	3 m	JZSP-C7M23G-03-E	JZSP-C7M24G-03-E	
		5 m	JZSP-C7M23G-05-E	JZSP-C7M24G-05-E	
		10 m	JZSP-C7M23G-10-E	JZSP-C7M24G-10-E	
		15 m	JZSP-C7M23G-15-E	JZSP-C7M24G-15-E	
		20 m	JZSP-C7M23G-20-E	JZSP-C7M24G-20-E	
		30 m	JZSP-C7M23G-30-E	JZSP-C7M24G-30-E	
		40 m	JZSP-C7M23G-40-E	JZSP-C7M24G-40-E	
		50 m	JZSP-C7M23G-50-E	JZSP-C7M24G-50-E	
SGM7A-08 and -10 750 W, 1.0 kW		3 m	JZSP-C7M33G-03-E	JZSP-C7M34G-03-E	
		5 m	JZSP-C7M33G-05-E	JZSP-C7M34G-05-E	
		10 m	JZSP-C7M33G-10-E	JZSP-C7M34G-10-E	
		15 m	JZSP-C7M33G-15-E	JZSP-C7M34G-15-E	
		20 m	JZSP-C7M33G-20-E	JZSP-C7M34G-20-E	
		30 m	JZSP-C7M33G-30-E	JZSP-C7M34G-30-E	
		40 m	JZSP-C7M33G-40-E	JZSP-C7M34G-40-E	
		50 m	JZSP-C7M33G-50-E	JZSP-C7M34G-50-E	

* Use Flexible Cables for moving parts of machines, such as robots. The recommended bending radius (R) is 90 mm or larger.

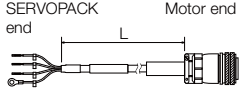
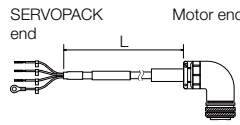
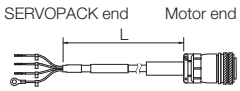
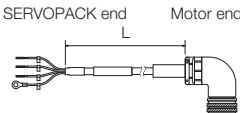
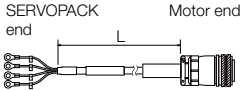
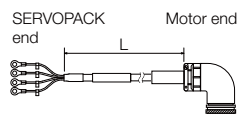
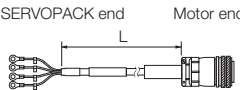
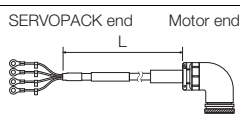
Servo-motor Model	Name	Connector Specifications	Length (L)	Order Number		Appearance
				Standard Cable	Flexible Cable*1	
SGM7A-15	For Servomotors without Holding Brakes	Straight	3 m	JZSP-UVA101-03-E	JZSP-UVA121-03-E	
			5 m	JZSP-UVA101-05-E	JZSP-UVA121-05-E	
			10 m	JZSP-UVA101-10-E	JZSP-UVA121-10-E	
			15 m	JZSP-UVA101-15-E	JZSP-UVA121-15-E	
			20 m	JZSP-UVA101-20-E	JZSP-UVA121-20-E	
		Right-angle	3 m	JZSP-UVA102-03-E	JZSP-UVA122-03-E	
			5 m	JZSP-UVA102-05-E	JZSP-UVA122-05-E	
			10 m	JZSP-UVA102-10-E	JZSP-UVA122-10-E	
			15 m	JZSP-UVA102-15-E	JZSP-UVA122-15-E	
			20 m	JZSP-UVA102-20-E	JZSP-UVA122-20-E	
1.5 kW	For Servomotors with Holding Brakes	Straight	3 m	JZSP-UVA131-03-E	JZSP-UVA141-03-E	
			5 m	JZSP-UVA131-05-E	JZSP-UVA141-05-E	
			10 m	JZSP-UVA131-10-E	JZSP-UVA141-10-E	
			15 m	JZSP-UVA131-15-E	JZSP-UVA141-15-E	
			20 m	JZSP-UVA131-20-E	JZSP-UVA141-20-E	
	(Set of Two Cables*2)	Right-angle	3 m	JZSP-UVA132-03-E	JZSP-UVA142-03-E	
			5 m	JZSP-UVA132-05-E	JZSP-UVA142-05-E	
			10 m	JZSP-UVA132-10-E	JZSP-UVA142-10-E	
			15 m	JZSP-UVA132-15-E	JZSP-UVA142-15-E	
			20 m	JZSP-UVA132-20-E	JZSP-UVA142-20-E	
SGM7A-20	For Servomotors without Holding Brakes	Straight	3 m	JZSP-UVA301-03-E	JZSP-UVA321-03-E	
			5 m	JZSP-UVA301-05-E	JZSP-UVA321-05-E	
			10 m	JZSP-UVA301-10-E	JZSP-UVA321-10-E	
			15 m	JZSP-UVA301-15-E	JZSP-UVA321-15-E	
			20 m	JZSP-UVA301-20-E	JZSP-UVA321-20-E	
		Right-angle	3 m	JZSP-UVA302-03-E	JZSP-UVA322-03-E	
			5 m	JZSP-UVA302-05-E	JZSP-UVA322-05-E	
			10 m	JZSP-UVA302-10-E	JZSP-UVA322-10-E	
			15 m	JZSP-UVA302-15-E	JZSP-UVA322-15-E	
			20 m	JZSP-UVA302-20-E	JZSP-UVA322-20-E	
2.0 kW	For Servomotors with Holding Brakes	Straight	3 m	JZSP-UVA331-03-E	JZSP-UVA341-03-E	
			5 m	JZSP-UVA331-05-E	JZSP-UVA341-05-E	
			10 m	JZSP-UVA331-10-E	JZSP-UVA341-10-E	
			15 m	JZSP-UVA331-15-E	JZSP-UVA341-15-E	
			20 m	JZSP-UVA331-20-E	JZSP-UVA341-20-E	
	(Set of Two Cables*2)	Right-angle	3 m	JZSP-UVA332-03-E	JZSP-UVA342-03-E	
			5 m	JZSP-UVA332-05-E	JZSP-UVA342-05-E	
			10 m	JZSP-UVA332-10-E	JZSP-UVA342-10-E	
			15 m	JZSP-UVA332-15-E	JZSP-UVA342-15-E	
			20 m	JZSP-UVA332-20-E	JZSP-UVA342-20-E	

*1. Use Flexible Cables for moving parts of machines, such as robots. The recommended bending radius (R) is 90 mm or larger.

*2. This order number is for a set of two cables (Main Power Supply Cable and Holding Brake Cable). When you purchase them separately, the order numbers for Main Power Supply Cables are the same as for a Servomotor without a Holding Brake.

The following order numbers are for a Holding Brake Cable. These Standard Cables are Flexible Cables.

- Cable with Straight Plug: JZSP-U7B23-□□-E
- Cable with Right-angle Plug: JZSP-U7B24-□□-E

Rotary Servomotors
SGM7A

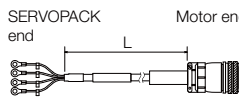
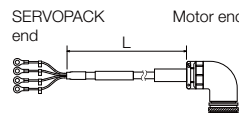
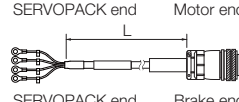
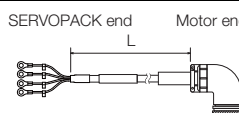
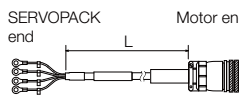
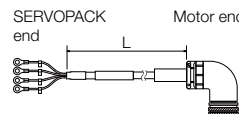
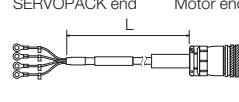
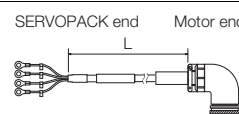
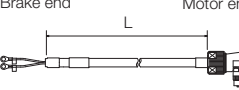
Servo-motor Model	Name	Connector Specifications	Length (L)	Order Number		Appearance
				Standard Cable	Flexible Cable* ¹	
SGM7A-25 2.5 kW	For Servomotors without Holding Brakes	Straight	3 m	JZSP-UVA501-03-E	JZSP-UVA521-03-E	
			5 m	JZSP-UVA501-05-E	JZSP-UVA521-05-E	
			10 m	JZSP-UVA501-10-E	JZSP-UVA521-10-E	
			15 m	JZSP-UVA501-15-E	JZSP-UVA521-15-E	
		Right-angle	3 m	JZSP-UVA502-03-E	JZSP-UVA522-03-E	
			5 m	JZSP-UVA502-05-E	JZSP-UVA522-05-E	
			10 m	JZSP-UVA502-10-E	JZSP-UVA522-10-E	
			15 m	JZSP-UVA502-15-E	JZSP-UVA522-15-E	
	(Set of Two Cables* ²)	Straight	3 m	JZSP-U7A551-03-E	JZSP-U7A561-03-E	
			5 m	JZSP-U7A551-05-E	JZSP-U7A561-05-E	
			10 m	JZSP-U7A551-10-E	JZSP-U7A561-10-E	
			15 m	JZSP-U7A551-15-E	JZSP-U7A561-15-E	
		Right-angle	3 m	JZSP-U7A552-03-E	JZSP-U7A562-03-E	
			5 m	JZSP-U7A552-05-E	JZSP-U7A562-05-E	
			10 m	JZSP-U7A552-10-E	JZSP-U7A562-10-E	
			15 m	JZSP-U7A552-15-E	JZSP-U7A562-15-E	
SGM7A-30 3.0 kW	For Servomotors without Holding Brakes	Straight	3 m	JZSP-UVA601-03-E	JZSP-UVA621-03-E	
			5 m	JZSP-UVA601-05-E	JZSP-UVA621-05-E	
			10 m	JZSP-UVA601-10-E	JZSP-UVA621-10-E	
			15 m	JZSP-UVA601-15-E	JZSP-UVA621-15-E	
		Right-angle	3 m	JZSP-UVA602-03-E	JZSP-UVA622-03-E	
			5 m	JZSP-UVA602-05-E	JZSP-UVA622-05-E	
			10 m	JZSP-UVA602-10-E	JZSP-UVA622-10-E	
			15 m	JZSP-UVA602-15-E	JZSP-UVA622-15-E	
	(Set of Two Cables* ²)	Straight	3 m	JZSP-UVA631-03-E	JZSP-UVA641-03-E	
			5 m	JZSP-UVA631-05-E	JZSP-UVA641-05-E	
			10 m	JZSP-UVA631-10-E	JZSP-UVA641-10-E	
			15 m	JZSP-UVA631-15-E	JZSP-UVA641-15-E	
		Right-angle	3 m	JZSP-UVA632-03-E	JZSP-UVA642-03-E	
			5 m	JZSP-UVA632-05-E	JZSP-UVA642-05-E	
			10 m	JZSP-UVA632-10-E	JZSP-UVA642-10-E	
			15 m	JZSP-UVA632-15-E	JZSP-UVA642-15-E	
			20 m	JZSP-UVA632-20-E	JZSP-UVA642-20-E	

*1. Use Flexible Cables for moving parts of machines, such as robots. The recommended bending radius (R) is 90 mm or larger.

*2. This order number is for a set of two cables (Main Power Supply Cable and Holding Brake Cable).
When you purchase them separately, the order numbers for Main Power Supply Cables are the same as for a Servomotor without a Holding Brake.
The following order numbers are for a Holding Brake Cable. These Standard Cables are Flexible Cables.

- Cable with Straight Plug: JZSP-U7B23-□□-E
- Cable with Right-angle Plug: JZSP-U7B24-□□-E

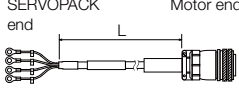
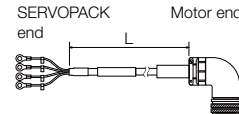
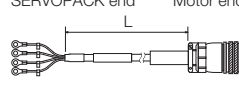
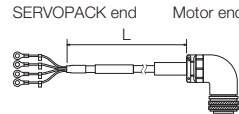
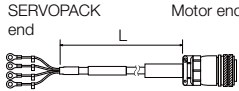
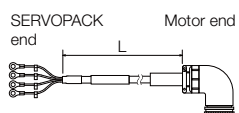
Servo-motor Model	Name	Connector Specifications	Length (L)	Order Number		Appearance
				Standard Cable	Flexible Cable* ¹	
SGM7A-40 and -50	For Servomotors without Holding Brakes	Straight	3 m	JZSP-UVA701-03-E	JZSP-UVA721-03-E	
			5 m	JZSP-UVA701-05-E	JZSP-UVA721-05-E	
			10 m	JZSP-UVA701-10-E	JZSP-UVA721-10-E	
			15 m	JZSP-UVA701-15-E	JZSP-UVA721-15-E	
			20 m	JZSP-UVA701-20-E	JZSP-UVA721-20-E	
		Right-angle	3 m	JZSP-UVA702-03-E	JZSP-UVA722-03-E	
			5 m	JZSP-UVA702-05-E	JZSP-UVA722-05-E	
			10 m	JZSP-UVA702-10-E	JZSP-UVA722-10-E	
			15 m	JZSP-UVA702-15-E	JZSP-UVA722-15-E	
			20 m	JZSP-UVA702-20-E	JZSP-UVA722-20-E	
4.0 kW, 5.0 kW	For Servomotors with Holding Brakes	Straight	3 m	JZSP-UVA731-03-E	JZSP-UVA741-03-E	
			5 m	JZSP-UVA731-05-E	JZSP-UVA741-05-E	
			10 m	JZSP-UVA731-10-E	JZSP-UVA741-10-E	
			15 m	JZSP-UVA731-15-E	JZSP-UVA741-15-E	
			20 m	JZSP-UVA731-20-E	JZSP-UVA741-20-E	
	(Set of Two Cables* ²)	Right-angle	3 m	JZSP-UVA732-03-E	JZSP-UVA742-03-E	
			5 m	JZSP-UVA732-05-E	JZSP-UVA742-05-E	
			10 m	JZSP-UVA732-10-E	JZSP-UVA742-10-E	
			15 m	JZSP-UVA732-15-E	JZSP-UVA742-15-E	
			20 m	JZSP-UVA732-20-E	JZSP-UVA742-20-E	
SGM7A-70* ³	For Servomotors without Holding Brakes	Straight	3 m	JZSP-UVA901-03-E	JZSP-UVA921-03-E	
			5 m	JZSP-UVA901-05-E	JZSP-UVA921-05-E	
			10 m	JZSP-UVA901-10-E	JZSP-UVA921-10-E	
			15 m	JZSP-UVA901-15-E	JZSP-UVA921-15-E	
			20 m	JZSP-UVA901-20-E	JZSP-UVA921-20-E	
		Right-angle	3 m	JZSP-UVA902-03-E	JZSP-UVA922-03-E	
			5 m	JZSP-UVA902-05-E	JZSP-UVA922-05-E	
			10 m	JZSP-UVA902-10-E	JZSP-UVA922-10-E	
			15 m	JZSP-UVA902-15-E	JZSP-UVA922-15-E	
			20 m	JZSP-UVA902-20-E	JZSP-UVA922-20-E	

*1. Use Flexible Cables for moving parts of machines, such as robots. The recommended bending radius (R) is 90 mm or larger.

*2. This order number is for a set of two cables (Main Power Supply Cable and Holding Brake Cable). When you purchase them separately, the order numbers for Main Power Supply Cables are the same as for a Servomotor without a Holding Brake.

The following order numbers are for a Holding Brake Cable. These Standard Cables are Flexible Cables.

- Cable with Straight Plug: JZSP-U7B23-□□-E
- Cable with Right-angle Plug: JZSP-U7B24-□□-E

*3. A cooling fan is built into the SGM7A-70 Servomotor. There is no specified cable to connect to the built-in cooling fan connector. Use appropriate wiring materials for the built-in cooling fan connector specifications. The cable is available from Yaskawa Controls Co., Ltd. Refer to the following manual for the built-in cooling fan connector specifications that are required to select the cable.

 *Σ-7-Series AC Servo Drive Peripheral Device Selection Manual (Manual No.: SIEP S80001 32)*

◆ Encoder Cables of 20 m or Less

Servomotor Model	Name	Length (L)	Order Number		Appearance
			Standard Cable	Flexible Cable*1	
SGM7A-A5 to -10 50 W to 1.0 kW	For incremental encoder, or batteryless absolute encoder Cable installed toward load	3 m	JZSP-C7PI0D-03-E	JZSP-C7PI2D-03-E	
		5 m	JZSP-C7PI0D-05-E	JZSP-C7PI2D-05-E	
		10 m	JZSP-C7PI0D-10-E	JZSP-C7PI2D-10-E	
		15 m	JZSP-C7PI0D-15-E	JZSP-C7PI2D-15-E	
		20 m	JZSP-C7PI0D-20-E	JZSP-C7PI2D-20-E	
	For incremental encoder, or batteryless absolute encoder Cable installed away from load	3 m	JZSP-C7PI0E-03-E	JZSP-C7PI2E-03-E	
		5 m	JZSP-C7PI0E-05-E	JZSP-C7PI2E-05-E	
		10 m	JZSP-C7PI0E-10-E	JZSP-C7PI2E-10-E	
		15 m	JZSP-C7PI0E-15-E	JZSP-C7PI2E-15-E	
		20 m	JZSP-C7PI0E-20-E	JZSP-C7PI2E-20-E	
	For absolute encoder: With Battery Case*2 Cable installed toward load	3 m	JZSP-C7PA0D-03-E	JZSP-C7PA2D-03-E	
		5 m	JZSP-C7PA0D-05-E	JZSP-C7PA2D-05-E	
		10 m	JZSP-C7PA0D-10-E	JZSP-C7PA2D-10-E	
		15 m	JZSP-C7PA0D-15-E	JZSP-C7PA2D-15-E	
		20 m	JZSP-C7PA0D-20-E	JZSP-C7PA2D-20-E	
	For absolute encoder: With Battery Case*2 Cable installed away from load	3 m	JZSP-C7PA0E-03-E	JZSP-C7PA2E-03-E	
		5 m	JZSP-C7PA0E-05-E	JZSP-C7PA2E-05-E	
		10 m	JZSP-C7PA0E-10-E	JZSP-C7PA2E-10-E	
		15 m	JZSP-C7PA0E-15-E	JZSP-C7PA2E-15-E	
		20 m	JZSP-C7PA0E-20-E	JZSP-C7PA2E-20-E	
SGM7A-15 to -70 1.5 kW to 7.0 kW	For incremental encoder, or batteryless absolute encoder	3 m	JZSP-CVP01-03-E	JZSP-CVP11-03-E	
		5 m	JZSP-CVP01-05-E	JZSP-CVP11-05-E	
		10 m	JZSP-CVP01-10-E	JZSP-CVP11-10-E	
		15 m	JZSP-CVP01-15-E	JZSP-CVP11-15-E	
		20 m	JZSP-CVP01-20-E	JZSP-CVP11-20-E	
		3 m	JZSP-CVP02-03-E*3	JZSP-CVP12-03-E	
		5 m	JZSP-CVP02-05-E*3	JZSP-CVP12-05-E	
		10 m	JZSP-CVP02-10-E*3	JZSP-CVP12-10-E	
	For absolute encoder: With Battery Case*2	15 m	JZSP-CVP02-15-E*3	JZSP-CVP12-15-E	
		20 m	JZSP-CVP02-20-E*3	JZSP-CVP12-20-E	
		3 m	JZSP-CVP06-03-E	JZSP-CVP26-03-E	
		5 m	JZSP-CVP06-05-E	JZSP-CVP26-05-E	
		10 m	JZSP-CVP06-10-E	JZSP-CVP26-10-E	
		15 m	JZSP-CVP06-15-E	JZSP-CVP26-15-E	
		20 m	JZSP-CVP06-20-E	JZSP-CVP26-20-E	
		3 m	JZSP-CVP07-03-E*3	JZSP-CVP27-03-E	
		5 m	JZSP-CVP07-05-E*3	JZSP-CVP27-05-E	
		10 m	JZSP-CVP07-10-E*3	JZSP-CVP27-10-E	
15 m	JZSP-CVP07-15-E*3	JZSP-CVP27-15-E			
20 m	JZSP-CVP07-20-E*3	JZSP-CVP27-20-E			

*1. Use Flexible Cables for moving parts of machines, such as robots. The recommended bending radius (R) is 90 mm or larger.

*2. If a battery is connected to the host controller, the Battery Case is not required. If so, use a cable for incremental encoders.

*3. You cannot use a right-angle connector for the encoder of a SGM7A-70A (7.0 kW) Servomotor. Use a straight connector.

◆ Relay Encoder Cable of 30 m to 50 m

Servomotor Model	Name	Length (L)	Order Number	Appearance
SGM7A-A5 to -10 50 W to 1.0 kW	Encoder-end Cable (for all types of encoders) Cable installed toward load	0.3 m	JZSP-C7PRCD-E	
	Encoder-end Cable (for all types of encoders) Cable installed away from load	0.3 m	JZSP-C7PRCE-E	
	Cables with Connectors on Both Ends (for all types of encoders)	30 m	JZSP-UCMP00-30-E	
		40 m	JZSP-UCMP00-40-E	
50 m		JZSP-UCMP00-50-E		
	Cable with a Battery Case (Required when an absolute encoder is used. *2)	0.3 m	JZSP-CSP12-E	
SGM7A-15 to -70 1.5 kW to 7.0 kW	Encoder-end Cable (for all types of encoders)	0.3 m	JZSP-CVP01-E	
			JZSP-CVP02-E*1	
	Cables with Connectors on Both Ends (for all types of encoders)	30 m	JZSP-UCMP00-30-E	
		40 m	JZSP-UCMP00-40-E	
		50 m	JZSP-UCMP00-50-E	
	Cable with a Battery Case (Required when an absolute encoder is used. *2)	0.3 m	JZSP-CSP12-E	

*1. You cannot use a right-angle connector for the encoder of a SGM7A-70A (7.0 kW) Servomotor. Use a straight connector.

*2. This Cable is not required if you use a Servomotor with a Batteryless Absolute Encoder, and you connect a battery to the host controller.

SGM7P

Model Designations

Without Gears

SGM7P - 01 A 7 A 2 1

Σ-7 Series
Servomotors:
SGM7P

1st+2nd
digits

3rd
digit

4th
digit

5th
digit

6th
digit

7th
digit

1st+2nd digits Rated Output

Code	Specification
01	100 W
02	200 W
04	400 W
08	750 W
15	1.5 kW

4th digit Serial Encoder

Code	Specification
6	24-bit batteryless absolute
7	24-bit absolute
F	24-bit incremental

6th digit Shaft End

Code	Specification
2	Straight without key
6	Straight with key and tap

3rd digit Power Supply Voltage

Code	Specification
A	200 VAC

5th digit Design Revision Order

Code	Specification
A	IP65
E	IP67

7th digit Options

Code	Specification
1	Without options
C	With holding brake (24 VDC)
E	With oil seal and holding brake (24 VDC)
S	With oil seal

With Gears

SGM7P - 01 A 7 A H B 0 1

Σ-7 Series
Servomotors:
SGM7P

1st+2nd
digits

3rd
digit

4th
digit

5th
digit

6th
digit

7th
digit

8th
digit

9th
digit

1st+2nd digits Rated Output

Code	Specification
01	100 W
02	200 W
04	400 W
08	750 W
15	1.5 kW

5th digit Design Revision Order

Code	Specification
A	IP55

8th digit Shaft End

Code	Specification
0	Flange output
2	Straight without key
6	Straight with key and tap

3rd digit Power Supply Voltage

Code	Specification
A	200 VAC

6th digit Gear Type

Code	Specification
H	HDS planetary low-backlash gear

9th digit Options

Code	Specification
1	Without options
C	With holding brake (24 VDC)

4th digit Serial Encoder

Code	Specification
6	24-bit batteryless absolute
7	24-bit absolute
F	24-bit incremental

7th digit Gear Ratio

Code	Specification
B	1/11
C	1/21
1	1/5
7	1/33

上正科技有限公司
購買、維修 此手冊零組件
電話： 037-466333

Email: service@repairtw.com
twid@repairtw.com
www.repairtw.com

Specifications and Ratings

Specifications

Voltage		200 V				
Model SGM7P-		01A	02A	04A	08A	15A
Time Rating		Continuous				
Thermal Class		UL: B, CE: B				
Insulation Resistance		500 VDC, 10 MΩ min.				
Withstand Voltage		1,500 VAC for 1 minute				
Excitation		Permanent magnet				
Mounting		Flange-mounted				
Drive Method		Direct drive				
Rotation Direction		Counterclockwise (CCW) for forward reference when viewed from the load side				
Vibration Class*1		V15				
Environmental Conditions	Surrounding Air Temperature	0°C to 40°C (With derating, usage is possible between 40°C and 60°C.)*3				
	Surrounding Air Humidity	20% to 80% relative humidity (with no condensation)				
	Installation Site	<ul style="list-style-type: none"> • Must be indoors and free of corrosive and explosive gases. • Must be well-ventilated and free of dust and moisture. • Must facilitate inspection and cleaning. • Must have an altitude of 1,000 m or less. (With derating, usage is possible between 1,000 m and 2,000 m.)*3 • Must be free of strong magnetic fields. 				
	Storage Environment	Store the Servomotor in the following environment if you store it with the power cable disconnected. Storage Temperature: -20°C to 60°C (with no freezing) Storage Humidity: 20% to 80% relative humidity (with no condensation)				
Shock Resistance*2	Impact Acceleration Rate at Flange	490 m/s ²				
	Number of Impacts	2 times				
Vibration Resistance*2	Vibration Acceleration Rate at Flange	49 m/s ²				
Applicable SERVOPACKs	SGD7S-	R90A, R90F	2R8A, 2R1F	2R8A, 2R8F	5R5A	120A
	SGD7W- SGD7C-	1R6A*4, 2R8A*4	2R8A, 5R5A*4, 7R6A*4		5R5A, 7R6A	-

*1. A vibration class of V15 indicates a vibration amplitude of 15 μm maximum on the Servomotor without a load at the rated motor speed.

*2. The given values are for when the Servomotor shaft is mounted horizontally and shock or vibration is applied in the directions shown in the following figures.

The strength of the vibration that the Servomotor can withstand depends on the application. Always check the vibration acceleration rate that is applied to the Servomotor with the actual equipment.

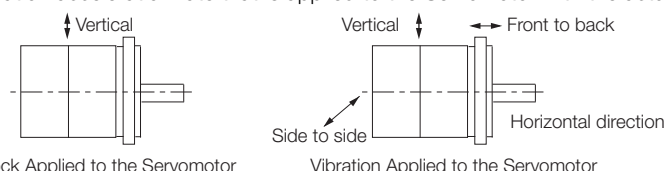

*3. Refer to the following section for the derating rates.

Derating Rates (page 82)

*4. If you use a Servomotor together with a Σ-7W or Σ-7C SERVOPACK, the control gain may not increase as much as with a Σ-7S SERVOPACK and other performances may be lower than those achieved with a Σ-7S SERVOPACK.

Ratings of Servomotors without Gears

Voltage		200 V					
Model SGM7P-		01A	02A	04A	08A	15A	
Rated Output*1	W	100	200	400	750	1500	
Rated Torque*1, *2	N·m	0.318	0.637	1.27	2.39	4.77	
Instantaneous Maximum Torque*1	N·m	0.955	1.91	3.82	7.16	14.3	
Rated Current*1	Arms	0.86	2.0	2.6	5.4	9.2	
Instantaneous Maximum Current*1	Arms	2.8	6.4	8.4	16.5	28.0	
Rated Motor Speed*1	min ⁻¹	3000					
Maximum Motor Speed*1	min ⁻¹	6000					
Torque Constant	N·m/Arms	0.401	0.355	0.524	0.476	0.559	
Motor Moment of Inertia	x10 ⁻⁴ kg·m ²	0.0592	0.263	0.409	2.10	4.02	
With holding brake		0.0892	0.415	0.561	2.98	4.90	
With batteryless absolute encoder		0.0607	0.264	0.410	2.10	4.02	
Rated Power Rate*1	kW/s	17.1	15.4	39.6	27.2	56.6	
With holding brake		11.3	9.7	28.8	19.1	46.4	
Rated Angular Acceleration Rate*1	rad/s ²	53700	24200	31100	11400	11900	
With holding brake		35600	15300	22600	8020	9730	
Derating Rate for Servomotor with Oil Seal	%	90			95		
Heat Sink Size*3	mm	250 × 250 × 6			300 × 300 × 12		
Protective Structure*4	Totally enclosed, self-cooled, IP65						
Holding Brake Specifications*5	Rated Voltage	24 VDC ±10%					
	Capacity	6	7.4	7.5			
	Holding Torque	0.318	0.637	1.27	2.39	4.77	
	Coil Resistance	Ω (at 20°C)	96	84.5	76.8		
	Rated Current	A (at 20°C)	0.25	0.31	0.31		
	Time Required to Release Brake	ms	80				
	Time Required to Brake	ms	100				
Allowable Load Moment of Inertia (Motor Moment of Inertia Ratio)*6		25 times	15 times	10 times	5 times		
	With External Regenerative Resistor and External Dynamic Brake Resistor*7						
Allowable Shaft Loads*8	LF	mm	20	25	35		
	Allowable Radial Load	N	78	245	392	490	
	Allowable Thrust Load	N	49	68	147		

*1. These values are for operation in combination with a SERVOPACK when the temperature of the armature winding is 100°C. The values for other items are at 20°C. These are typical values.

*2. The rated torques are the continuous allowable torque values at a surrounding air temperature of 40°C with an aluminum heat sink of the dimensions given in the table.

*3. Refer to the following section for the relation between the heat sinks and derating rate.

 Servomotor Heat Dissipation Conditions (page 82)

*4. This does not apply to the shaft opening. Protective structure specifications apply only when the special cable is used.

*5. Observe the following precautions if you use a Servomotor with a Holding Brake.

- The holding brake cannot be used to stop the Servomotor.
- The time required to release the brake and the time required to brake depend on which discharge circuit is used. Confirm that the operation delay time is appropriate for the actual equipment.
- The 24-VDC power supply is not provided by Yaskawa.

*6. The motor moment of inertia scaling factor is the value for a standard Servomotor without a Holding Brake.

*7. To externally connect a dynamic brake resistor, select hardware option specification 020 for the SERVOPACK.

However, you cannot externally connect a dynamic brake resistor if you use the following SERVOPACKS

(maximum applicable motor capacity: 400 W).

- SGD7S-R70□□□A020 to -2R8□□□A020
- SGD7W-1R6A20A020 to -2R8A20A020
- SGD7C-1R6AMAA020 to -2R8AMAA020

*8. Design the mechanical system so that the thrust and radial loads applied to the Servomotor shaft end during operation do not exceed the values given in the table.

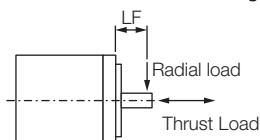

Ratings of Servomotors with Gears

All Models	Gear Mechanism				Protective Structure			Lost Motion [arc-min]		
	Planetary gear mechanism				Totally enclosed, self-cooled, IP55 (except for shaft opening)			3 max.		
Servomotor Model SGM7P-	Servomotor					Gear Output				
	Rated Output [W]	Rated Motor Speed [min ⁻¹]	Maximum Motor Speed [min ⁻¹]	Rated Torque [N·m]	Instantaneous Maximum Torque [N·m]	Gear Ratio	Rated Torque/Efficiency*1 [N·m/%]	Instantaneous Maximum Torque [N·m]	Rated Motor Speed [min ⁻¹]	Maximum Motor Speed [min ⁻¹]
01A□AH1□	100	3000	6000	0.318	0.955	1/5	1.05/78*2	4.30	600	1200
01A□AHB□						1/11	2.52/72	9.30	273	545
01A□AHC□						1/21	5.34/80	18.2	143	286
01A□AH7□						1/33	6.82/65	27.0	91	182
02A□AH1□	200	3000	6000	0.637	1.91	1/5	2.39/75	8.60	600	1200
02A□AHB□						1/11	5.74/82	19.4	273	545
02A□AHC□						1/21	10.2/76	35.9	143	286
02A□AH7□						1/33	17.0/81	57.3	91	182
04A□AH1□	400	3000	6000	1.27	3.82	1/5	5.33/84	17.8	600	1200
04A□AHB□						1/11	11.5/82	38.3	273	545
04A□AHC□						1/21	22.9/86	74.4	143	286
04A□AH7□						1/33	34.0/81	114.6	91	182
08A□AH1□	750	3000	6000	2.39	7.16	1/5	10.0/84	32.8	600	1200
08A□AHB□						1/11	23.1/88	73.6	273	545
08A□AHC□						1/21	42.1/84	138.0	143	286
08A□AH7□						1/33	69.3/88	220	91	182
15A□AH1□	1500	3000	6000	4.77	14.3	1/5	19.1/80	64.8	600	1200
15A□AHB□						1/11	45.6/87	146	273	545
15A□AHC□						1/21	87.1/87	278	143	214*3
15A□AH7□						1/33	142/90	443	91	136*3

*1. The gear output torque is expressed by the following formula.

$$\text{Gear output torque} = \text{Servomotor output torque} \times \frac{1}{\text{Gear ratio}} \times \text{Efficiency}$$

The gear efficiency depends on operating conditions such as the output torque, motor speed, and temperature. The values in the table are typical values for the rated torque, rated motor speed, and a surrounding air temperature of 25°C. They are reference values only.

*2. Use the Servomotor at an effective load ratio of 85% or less. The values in the table take the effective load ratio into consideration.

*3. The maximum motor speed calculated at the motor shaft is 4,500 min⁻¹ max.

Note: 1. The gears that are mounted to Yaskawa Servomotors have not been broken in.

Break in the Servomotor if necessary. First, operate the Servomotor at low speed with no load. If no problems occur, gradually increase the speed and load.

2. The no-load torque for a Servomotor with a Gear is high immediately after the Servomotor starts, and it then decreases and becomes stable after a few minutes. This is a common phenomenon caused by grease circulation in the gears and it does not indicate faulty gears.

3. Other specifications are the same as those for Servomotors without Gears.



Important

The SERVOPACK speed control range is 1:5,000. If you use Servomotors at extremely low speeds (0.02 min⁻¹ or lower at the gear output shaft), if you use Servomotors with a one-pulse feed reference for extended periods, or under some other operating conditions, the gear bearing lubrication may be insufficient. That may cause deterioration of the bearing or increase the load ratio. Contact your Yaskawa representative if you use a Servomotor under these conditions.

Servomotor Model SGM7P-	Moment of Inertia [$\times 10^{-4}$ kg·m ²]				With Low-Backlash Gears			Reference Diagram
	Shaft Output		Flange Output		Allowable Radial Load [N]	Allowable Thrust Load [N]	LF [mm]	
	Motor* + Gear	Gear	Motor* + Gear	Gear				
01A□AH1□	0.0642	0.005	0.0632	0.004	95	431	37	
01A□AHB□	0.119	0.060	0.118	0.059	192	895	53	
01A□AHC□	0.109	0.050	0.109	0.050	233	1087	53	
01A□AH7□	0.509	0.450	0.508	0.449	605	2581	75	
02A□AH1□	0.470	0.207	0.464	0.201	152	707	53	
02A□AHB□	0.456	0.193	0.455	0.192	192	895	53	
02A□AHC□	0.753	0.490	0.751	0.488	528	2254	75	
02A□AH7□	0.713	0.450	0.712	0.449	605	2581	75	
04A□AH1□	0.616	0.207	0.610	0.201	152	707	53	
04A□AHB□	0.979	0.570	0.969	0.560	435	1856	75	
04A□AHC□	0.899	0.490	0.897	0.488	528	2254	75	
04A□AH7□	1.03	0.620	1.01	0.610	951	4992	128	
08A□AH1□	3.20	1.10	3.16	1.06	343	1465	75	
08A□AHB□	2.70	0.600	2.69	0.590	435	1856	75	
08A□AHC□	5.10	3.00	5.08	2.98	830	4359	128	
08A□AH7□	4.90	2.80	4.89	2.79	951	4992	128	
15A□AH1□	7.82	3.80	7.55	3.53	540	2834	128	
15A□AHB□	7.42	3.40	7.36	3.34	684	3590	128	
15A□AHC□	9.82	5.80	9.72	5.70	2042	8840	151	
15A□AH7□	8.82	4.80	8.79	4.77	2338	10120	151	

* The moment of inertia for the Servomotor and gear is the value without a holding brake. You can calculate the moment of inertia for a Servomotor with a Gear and Holding Brake with the following formula.
 Motor moment of inertia for a Servomotor with a Holding Brake from *Ratings of Servomotors without Gears* (page 76) + Moment of inertia for the gear from the above table.



Important

During operation, the gear generates the loss at the gear mechanism and oil seal. The loss depends on the torque and motor speed conditions. The temperature rise depends on the loss and heat dissipation conditions. For the heat dissipation conditions, always refer to the following table and check the gear and motor temperatures with the actual equipment. If the temperature is too high, implement the following measures.

- Decrease the load ratio.
- Change the heat dissipation conditions.
- Use forced-air cooling for the motor with a cooling fan or other means.

Model	Heat Sink Size			
	1/5	1/11	1/21	1/33
SGM7P-01	C		A	
SGM7P-02			A	
SGM7P-04	C		B	
SGM7P-08			B	
SGM7P-15			B	

- A: 250 mm × 250 mm × 6 mm, aluminum plate
- B: 300 mm × 300 mm × 12 mm, aluminum plate
- C: 350 mm × 350 mm × 12 mm, aluminum plate

Servomotor Overload Protection Characteristics

The overload detection level is set for hot start conditions with a Servomotor surrounding air temperature of 40°C.

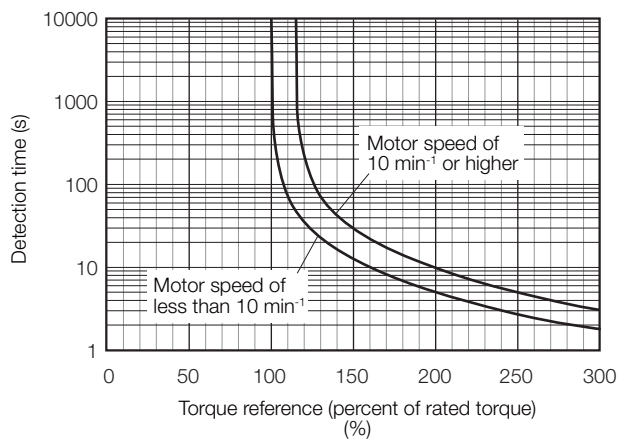

Note: The above overload protection characteristics do not mean that you can perform continuous duty operation with an output of 100% or higher. Use the Servomotor so that the effective torque remains within the continuous duty zone given in *Torque-Motor Speed Characteristics* (page 77).

上正科技有限公司

購買、維修 此手冊零組件

電話： 037-466333

Email: service@repairtw.com

Line id: @zzzz

www.repairtw.com

Allowable Load Moment of Inertia

The allowable load moments of inertia (motor moment of inertia ratios) for the Servomotors are given in the *Ratings of Servomotors without Gears* (page 76). The values are determined by the regenerative energy processing capacity of the SERVOPACK and are also affected by the drive conditions of the Servomotor. Perform the required Steps for each of the following cases.

Use the SigmaSize+ AC Servo Drive Capacity Selection Program to check the driving conditions. Contact your Yaskawa representative for information on this program.

◆ Exceeding the Allowable Load Moment of Inertia

Use one of the following measures to adjust the load moment of inertia to within the allowable value.

- Reduce the torque limit.
- Reduce the deceleration rate.
- Reduce the maximum motor speed.

If the above steps is not possible, install an external regenerative resistor.

Information

An Overvoltage Alarm (A.400) is likely to occur during deceleration if the load moment of inertia exceeds the allowable load moment of inertia. SERVOPACKs with a built-in regenerative resistor may generate a Regenerative Overload Alarm (A.320). Refer to *Built-In Regenerative Resistor* (page 472) for the regenerative power (W) that can be processed by the SERVO-PACKs.

Install an External Regenerative Resistor when the built-in regenerative resistor cannot process all of the regenerative power.

◆ SERVOPACKs without Built-in Regenerative Resistors

The following graph shows the allowable load moment of inertia scaling factor of the motor speed (reference values for deceleration operation at or above the rated torque). Application is possible without an external regenerative resistor within the allowable value. However, an External Regenerative Resistor is required in the shaded areas of the graphs.

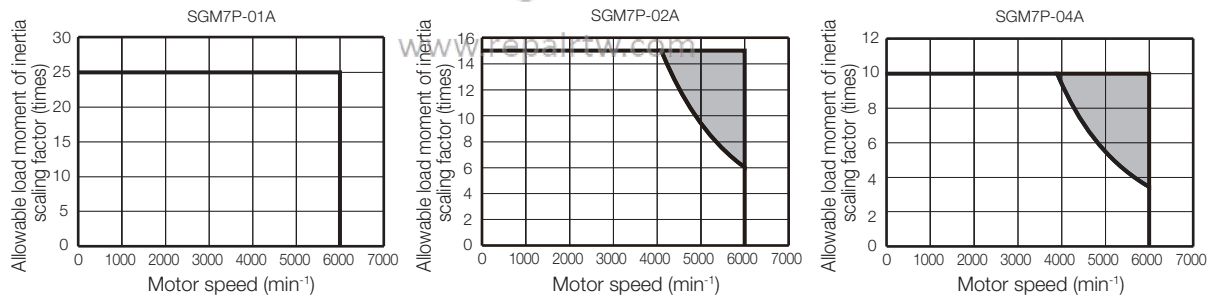

Note: Applicable SERVOPACK models: SGD7S-R70A, -R90A, -1R6A, -2R8A, -R70F, -R90F, -2R1F, and -2R8F

◆ When an External Regenerative Resistor Is Required

Install the External Regenerative Resistor. Refer to the following section for the recommended products.

External Regenerative Resistors (page 472)

Derating Rates

◆ Servomotor Heat Dissipation Conditions

The Servomotor ratings are the continuous allowable values at a surrounding air temperature of 40°C when a heat sink is installed on the Servomotor. If the Servomotor is mounted on a small device component, the Servomotor temperature may rise considerably because the surface for heat dissipation becomes smaller. Refer to the following graphs for the relation between the heat sink size and derating rate.

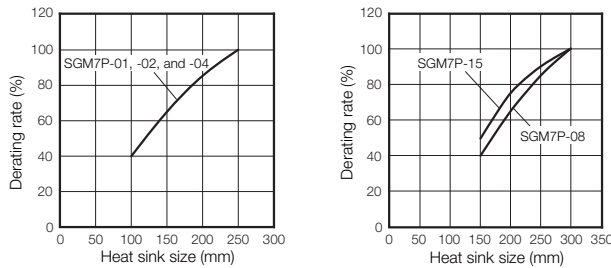

Important

The actual temperature rise depends on how the heat sink (i.e., the Servomotor mounting section) is attached to the installation surface, what material is used for the Servomotor mounting section, and the motor speed. Always check the Servomotor temperature with the actual equipment.

◆ Applications Where the Surrounding Air Temperature Exceeds 40°C

The Servomotor ratings are the continuous allowable values at a surrounding air temperature of 40°C. If you use a Servomotor at a surrounding air temperature that exceeds 40°C (60°C max.), apply a suitable derating rate from the following graphs.

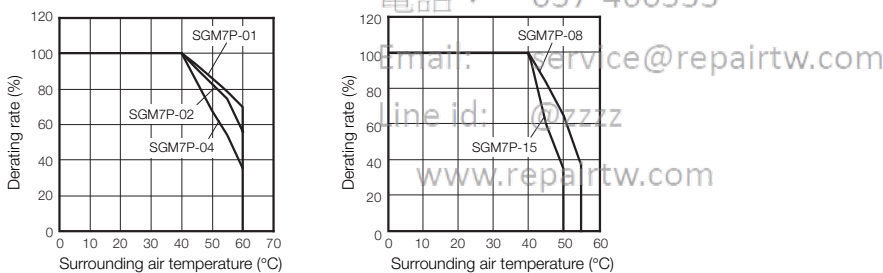

◆ Applications Where the Altitude Exceeds 1,000 m

The Servomotor ratings are the continuous allowable values at an altitude of 1,000 m or less. If you use a Servomotor at an altitude that exceeds 1,000 m (2,000 m max.), the heat dissipation effect of the air is reduced. Apply the appropriate derating rate from the following graphs.

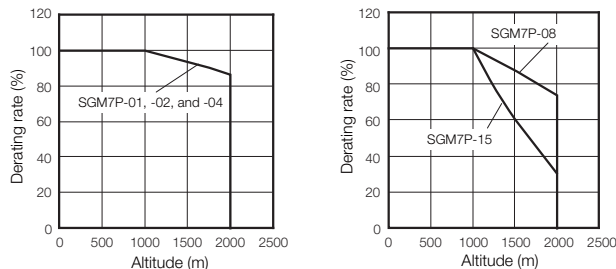

Information

When using Servomotors with derating, change the detection timing of overload warning and overload alarm based on the overload detection level of the motor given in *Servomotor Overload Protection Characteristics* (page 80).

Note: 1. Use the combination of the SERVOPACK and Servomotor so that the derating conditions are satisfied for both the SERVOPACK and Servomotor.

2. The derating rates are applicable only when the average motor speed is less than or equal to the rated motor speed. If the average motor speed exceeds the rated motor speed, consult with your Yaskawa representative.

External Dimensions

Servomotors without Gears

◆ SGM7P-01, -02, and -04

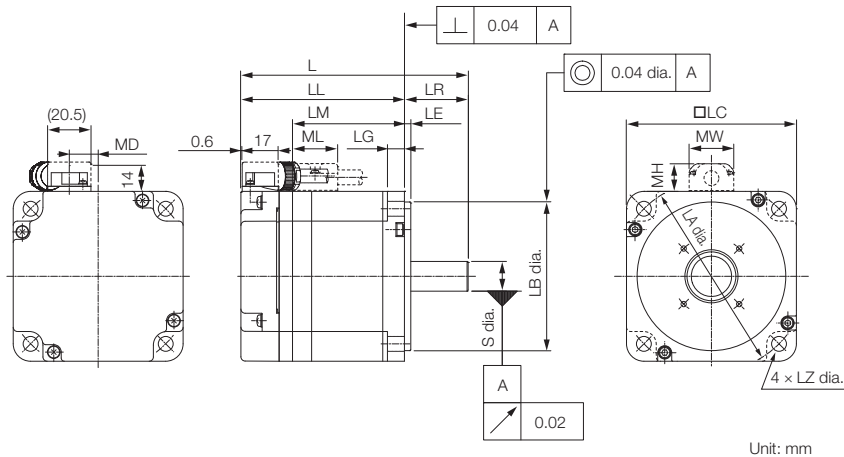

Model SGM7P-	L*	LL*	LM	Flange Dimensions							S	MD	MW	MH	ML	Approx. Mass* [kg]
				LR	LE	LG	LC	LA	LB	LZ						
01A□A2□	85 (115)	60 (90)	36	25	3	6	60	70	50 ⁰ _{-0.025}	5.5	8 ⁰ _{-0.009}	8.5	19	12	20	0.5 (0.9)
02A□A2□	97 (128.5)	67 (98.5)	43	30	3	8	80	90	70 ⁰ _{-0.030}	7	14 ⁰ _{-0.011}	13.6	21	13	21	1.1 (1.9)
04A□A2□	107 (138.5)	77 (108.5)	53	30	3	8	80	90	70 ⁰ _{-0.030}	7	14 ⁰ _{-0.011}	13.6	21	13	21	1.4 (2.2)

* For models that have a batteryless absolute encoder, L and LL are 8 mm greater and the approximate mass is 0.1 kg greater than the given value. Refer to the following section for the values for individual models.

☞ **Dimensions of Servomotors with Batteryless Absolute Encoders (page 89)**

Note: 1. The values in parentheses are for Servomotors with Holding Brakes.

2. The values for a straight, without key specification are given. Refer to the information given below for other shaft end specifications and option specifications.

■ Shaft End Specifications

- Straight with Key and Tap

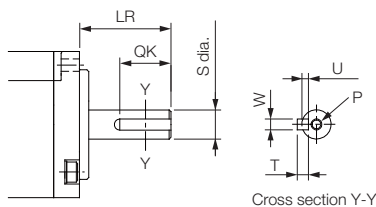

Model SGM7P-	LR	QK	S	W	T	U	P
01A□A6□	25	14	8 ⁰ _{-0.009}	3	3	1.8	M3×6L
02A□A6□	30	14	14 ⁰ _{-0.011}	5	5	3	M5×8L
04A□A6□	30	14	14 ⁰ _{-0.011}	5	5	3	M5×8L

■ Specifications of Options

- Oil Seal

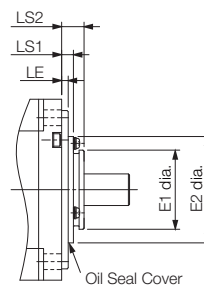

Model SGM7P-	Dimensions with Oil Seal				
	E1	E2	LS1	LS2	LE
01A□A2□	22	38	3.5	7	3
02A□A2□	35	47	5.2	10	3
04A□A2□					

◆ SGM7P-08 and -15

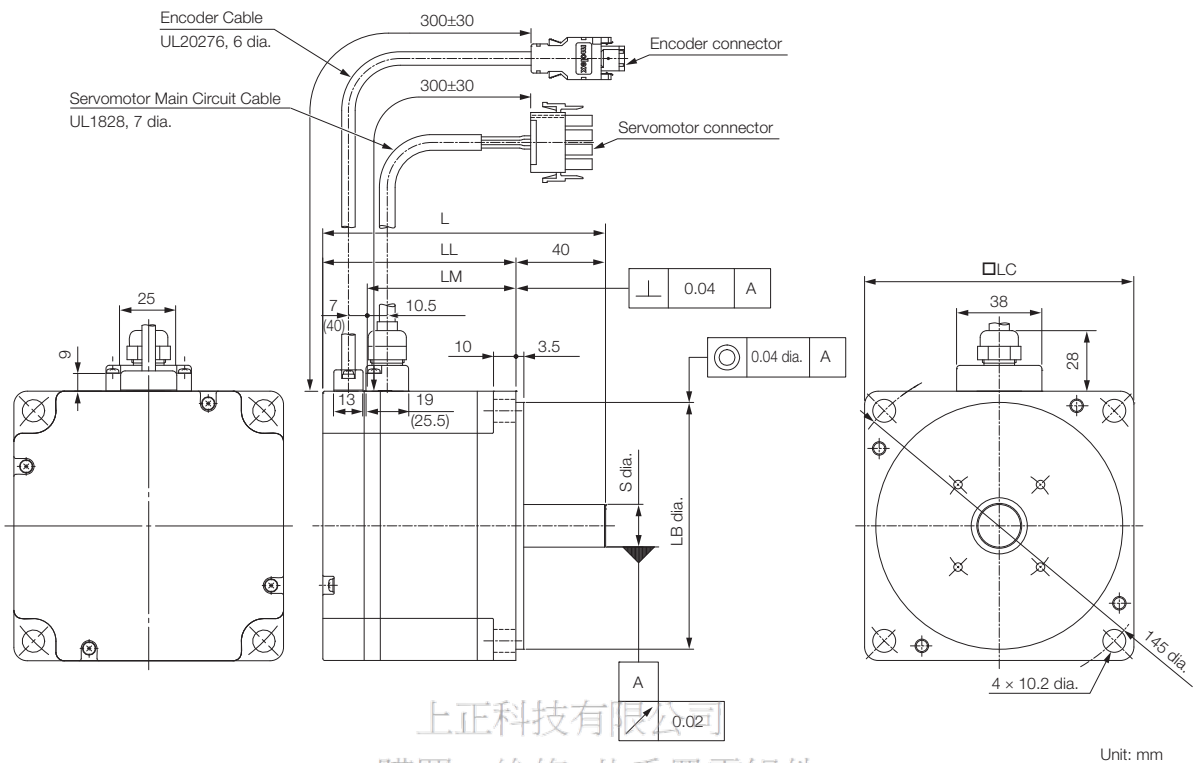

上正科技有限公司
購買、維修 此手冊零組件

Model SGM7P-	L*	LL*	LM	LB	LC	S	Approx. Mass* [kg]
08A□A2□	126.5 (160)	86.5 (120)	67.6	110 ⁰ _{-0.035}	120	19 ⁰ _{-0.013}	4.2 (5.9)
15A□A2□	154.5 (187.5)	114.5 (147.5)	95.6	110 ⁰ _{-0.035}	120	19 ⁰ _{-0.013}	6.6 (8.2)

* For models that have a batteryless absolute encoder, L and LL are 8 mm greater and the approximate mass is 0.1 kg greater than the given value. Refer to the following section for the values for individual models.

🔧 **Dimensions of Servomotors with Batteryless Absolute Encoders (page 89)**

Note: 1. The values in parentheses are for Servomotors with Holding Brakes.

2. The values for a straight, without key specification are given. Refer to the information given below for other shaft end specifications and option specifications.

■ Shaft End Specifications

- Straight with Key and Tap

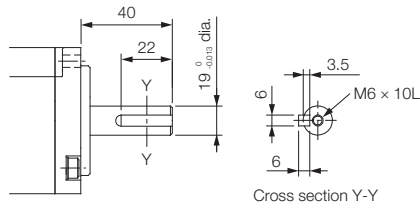

■ Specifications of Options

- Oil Seal

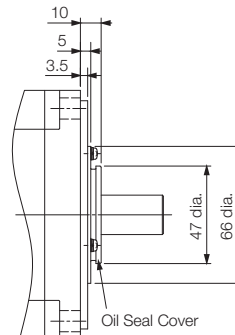

Servomotors with Gears

◆ SGM7P-01, -02, and -04

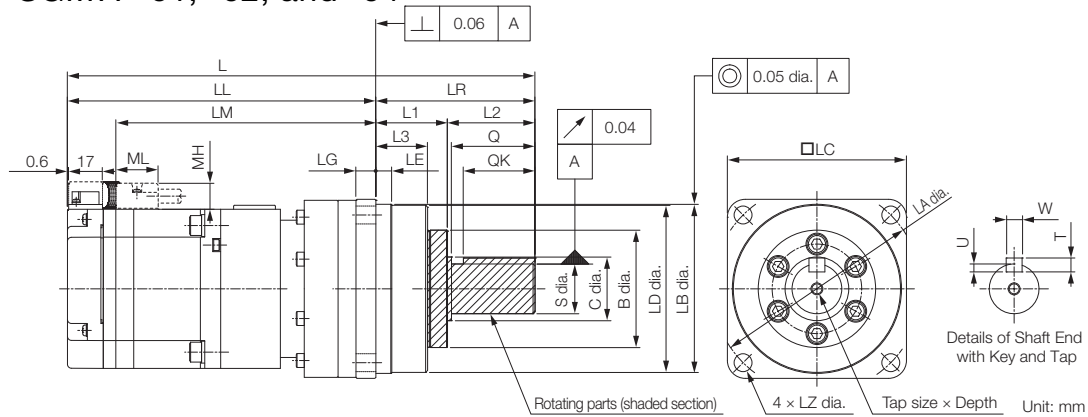

Model SGM7P-	Gear Ratio	L*	LL*	LM	Flange Dimensions								
					LR	LE	LG	B	LD	LB	LC	LA	LZ
01A□AH1□□	1/5	141.5 (171.5)	99.5 (129.5)	75.5	42	2.2	5	29	39.5	40 ⁰ _{-0.025}	40	46	3.4
01A□AHB□□	1/11	182 (212)	124 (154)	100	58	2.5	8	40	55.5	56 ⁰ _{-0.030}	60	70	5.5
01A□AHC□□	1/21												
01A□AH7□□	1/33	211 (241)	131 (161)	107	80	7.5	10	59	84	85 ⁰ _{-0.035}	90	105	9
02A□AH1□□	1/5	190 (221.5)	132 (163.5)	108	58	2.5	8	40	55.5	56 ⁰ _{-0.030}	60	70	5.5
02A□AHB□□	1/11	225 (256.5)	145 (176.5)	121	80	7.5	10	59	84	85 ⁰ _{-0.035}	90	105	9
02A□AHC□□	1/21												
02A□AH7□□	1/33												
04A□AH1□□	1/5	200 (231.5)	142 (173.5)	118	58	2.5	8	40	55.5	56 ⁰ _{-0.030}	60	70	5.5
04A□AHB□□	1/11	235 (266.5)	155 (186.5)	131	80	7.5	10	59	84	85 ⁰ _{-0.035}	90	105	9
04A□AHC□□	1/21												
04A□AH7□□	1/33	314 (345.5)	181 (212.5)	157	133	12.5	13	84	114	115 ⁰ _{-0.035}	120	135	11

Model SGM7P-	Flange Dimensions			Q	C	S	Tap Size × Depth	Key Dimensions				Approx. Mass* [kg]
	L1	L2	L3					QK	U	W	T	
01A□AH1□□	22	20	14.6	-	-	10 ⁰ _{-0.015}	M3 × 6L	15	2.5	4	4	0.9 (1.3)
01A□AHB□□	28	30	20	28	20	16 ⁰ _{-0.018}	M4 × 8L	25	3	5	5	1.6 (2.0)
01A□AHC□□												
01A□AH7□□	36	44	26	42	32	25 ⁰ _{-0.021}	M6 × 12L	36	4	8	7	3.4 (3.8)
02A□AH1□□	28	30	20	28	20	16 ⁰ _{-0.018}	M4 × 8L	25	3	5	5	2.3 (2.9)
02A□AHB□□												2.4 (3.0)
02A□AHC□□	36	44	26	42	32	25 ⁰ _{-0.021}	M6 × 12L	36	4	8	7	4.2 (5.0)
02A□AH7□□												
04A□AH1□□	28	30	20	28	20	16 ⁰ _{-0.018}	M4 × 8L	25	3	5	5	2.6 (3.2)
04A□AHB□□	36	44	26	42	32	25 ⁰ _{-0.021}	M6 × 12L	36	4	8	7	4.5 (5.3)
04A□AHC□□												
04A□AH7□□	48	85	33	82	44	40 ⁰ _{-0.025}	M10 × 20L	70	5	12	8	9.2 (10.0)

* For models that have a batteryless absolute encoder, L and LL are 8 mm greater and the approximate mass is 0.1 kg greater than the given value. Refer to the following section for the values for individual models.

☞ **Dimensions of Servomotors with Batteryless Absolute Encoders (page 89)**

Note: 1. The values in parentheses are for Servomotors with Holding Brakes.

2. Gear dimensions are different from those of the Σ, Σ-II, and Σ-III Series.

3. The values for the shaft end are for a straight shaft with key and tap. If a key and tap are not necessary, specify shaft end code 2 for the 8th digit.

■ Flange Output Face

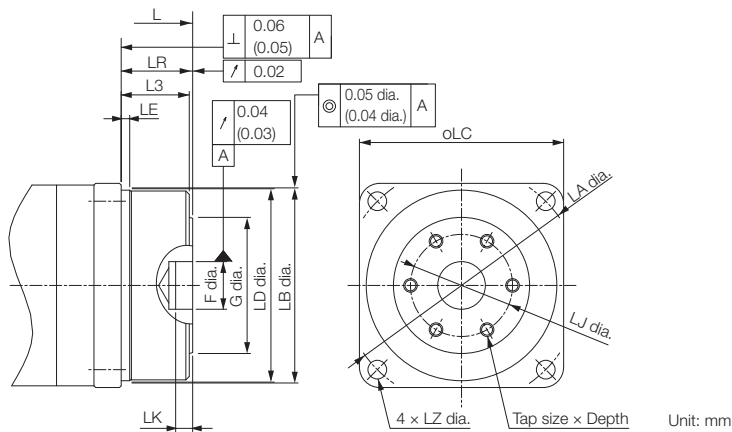

Note: The geometric tolerance in parentheses is the value for LC = 40.

Model SGM7P-	Gear Ratio	L*	LR	LJ	F	G	LK	No. of Taps × Tap Size × Depth	Approx. Mass* [kg]
01A□AH10□	1/5	114.5 (144.5)	15	18	$5^{+0.012}_0$	24	3	3 × M4 × 6L	0.8 (1.2)
01A□AHB0□	1/11	145 (175)	21	30	$14^{+0.018}_0$	40	5	6 × M4 × 7L	1.5 (1.9)
01A□AHC0□	1/21	158 (188)	27	45	$24^{+0.021}_0$	59	5	6 × M6 × 10L	3.0 (3.4)
02A□AH10□	1/5	153 (184.5)	21	30	$14^{+0.018}_0$	40	5	6 × M4 × 7L	2.2 (2.8)
02A□AHB0□	1/11	172 (203.5)	27	45	$24^{+0.021}_0$	59	5	6 × M6 × 10L	2.3 (2.9)
02A□AHC0□	1/21	163 (194.5)	21	30	$14^{+0.018}_0$	40	5	6 × M4 × 7L	3.8 (4.6)
02A□AH70□	1/33	182 (213.5)	27	45	$24^{+0.021}_0$	59	5	6 × M6 × 10L	2.5 (3.1)
04A□AH10□	1/5	216 (247.5)	35	60	$32^{+0.025}_0$	84	5	6 × M8 × 12L	4.1 (4.9)
04A□AHB0□	1/11							6 × M4 × 7L	7.8 (8.6)
04A□AHC0□	1/21							6 × M6 × 10L	
04A□AH70□	1/33							6 × M8 × 12L	

* For models that have a batteryless absolute encoder, L is 8 mm greater and the approximate mass is 0.1 kg greater than the given value. Refer to the following section for the values for individual models.

🔧 **Dimensions of Servomotors with Batteryless Absolute Encoders (page 89)**

Note: 1. The values in parentheses are for Servomotors with Holding Brakes.

2. Dimensions not found in the above table are the same as those in the table on the previous page.

Important

For a Servomotor with a flange output that has square gear flange dimensions (□LC) of 40 mm, we recommend that you design the Servomotor with the dimensions shown in the following figure in order to secure a gap between the gear oil seal and the connecting parts on the load side.

0.5 min. Connecting parts on the load side

24 dia. max.

◆ SGM7P-08 and -15

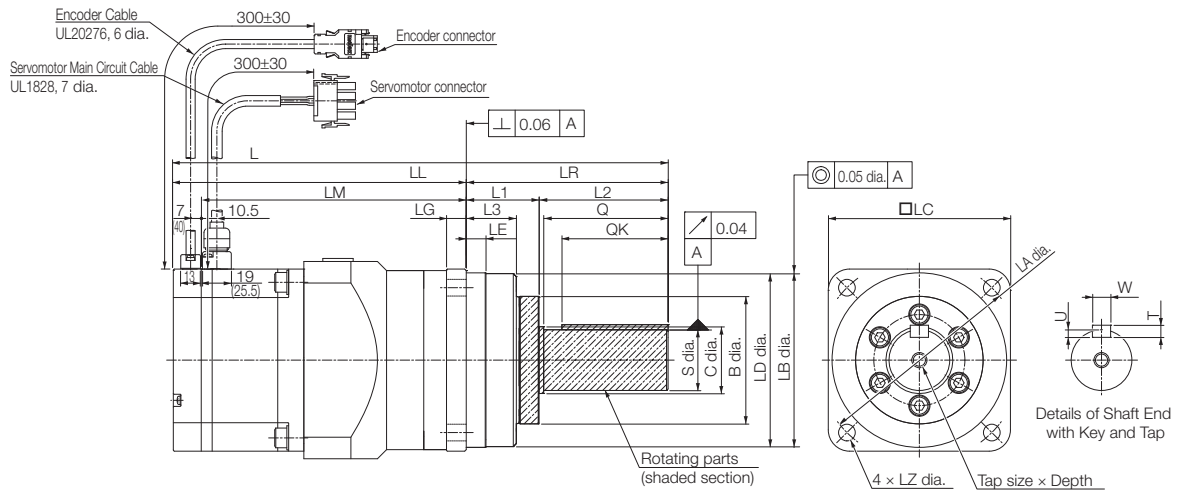

Unit: mm

Model SGM7P-	Gear Ratio	L*	LL*	LM	Flange Dimensions								
					LR	LE	LG	B	LD	LB	LC	LA	LZ
08A□AH1□□	1/5	253.5	173.5	154.6	80	7.5	10	59	84	85 ⁰ _{-0.035}	90	105	9
08A□AHB□□	1/11	(287)	(207)										
08A□AHC□□	1/21	326.5	193.5	174.6	133	12.5	13	84	114	115 ⁰ _{-0.035}	120	135	11
08A□AH7□□	1/33	(360)	(227)										
15A□AH1□□	1/5	354.5	221.5	202.6	133	12.5	13	84	114	115 ⁰ _{-0.035}	120	135	11
15A□AHB□□	1/11	(387.5)	(254.5)										
15A□AHC□□	1/21	393.5	237.5	218.6	156	12	16	122	163	165 ⁰ _{-0.063}	170	190	14
15A□AH7□□	1/33	(426.5)	(270.5)										

Model SGM7P-	Flange Dimensions			Q	C	S	Tap Size x Depth	Key Dimensions				Approx. Mass* [kg]
	L1	L2	L3					QK	U	W	T	
08A□AH1□□	36	44	26	42	32	25 ⁰ _{-0.021}	M6 x 12L	36	4	8	7	6.9 (8.6)
08A□AHB□□												7.1 (8.8)
08A□AHC□□	48	85	33	82	44	40 ⁰ _{-0.025}	M10 x 20L	70	5	12	8	12 (13.7)
08A□AH7□□												
15A□AH1□□	48	85	33	82	44	40 ⁰ _{-0.025}	M10 x 20L	70	5	12	8	13.9 (15.5)
15A□AHB□□												14.4 (16.0)
15A□AHC□□	70	86	51	82	56	50 ⁰ _{-0.025}	M10 x 20L	70	5.5	14	9	25.7 (27.3)
15A□AH7□□												

* For models that have a batteryless absolute encoder, L and LL are 8 mm greater and the approximate mass is 0.1 kg greater than the given value. Refer to the following section for the values for individual models.

☞ Dimensions of Servomotors with Batteryless Absolute Encoders (page 89)

Note: 1. The values in parentheses are for Servomotors with Holding Brakes.

2. Gear dimensions are different from those of the Σ, Σ-II, and Σ-III Series.

3. The values for the shaft end are for a straight shaft with key and tap. If a key and tap are not necessary, specify shaft end code 2 for the 8th digit.

■ Flange Output Face

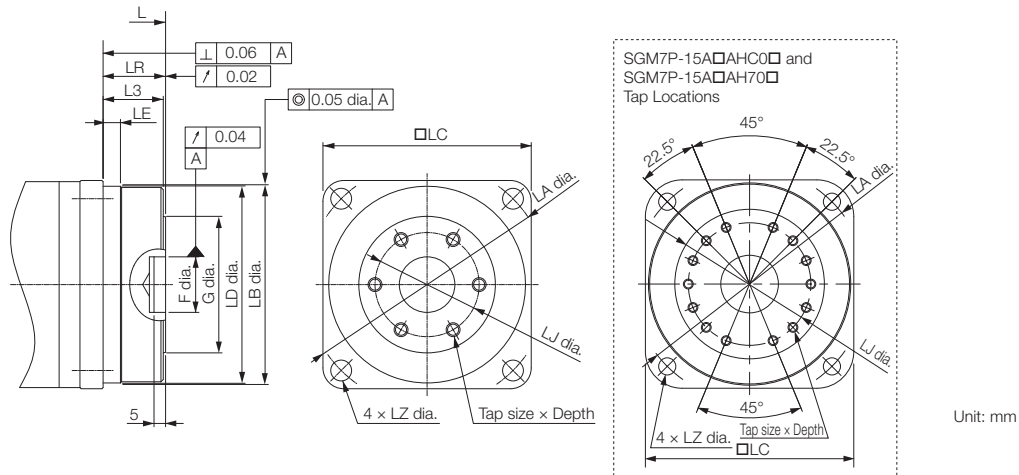

Model SGM7P-	Gear Ratio	L*	LR	LJ	F	G	LK	No. of Taps × Tap Size × Depth	Approx. Mass* [kg]
08A□AH10□	1/5	200.5	27	45	24 ^{+0.021} ₀	59	5	6 × M6 × 10L	6.5 (8.2)
08A□AHB0□	1/11	(234)							6.7 (8.4)
08A□AHC0□	1/21	228.5	35	60	32 ^{+0.025} ₀	84	5	6 × M8 × 12L	10.6 (12.3)
08A□AH70□	1/33	(262)							12.5 (14.1)
15A□AH10□	1/5	256.5	35	60	32 ^{+0.025} ₀	84	5	6 × M8 × 12L	13 (14.6)
15A□AHB0□	1/11	(289.5)							22.7 (24.3)
15A□AHC0□	1/21	290.5	53	100	47 ^{+0.025} ₀	122	7	14 × M8 × 12L	22.7 (24.3)
15A□AH70□	1/33	(323.5)							

* For models that have a batteryless absolute encoder, L is 8 mm greater and the approximate mass is 0.1 kg greater than the given value. Refer to the following section for the values for individual models.

🔧 **Dimensions of Servomotors with Batteryless Absolute Encoders (page 89)**

Note: 1. The values in parentheses are for Servomotors with Holding Brakes.

2. Dimensions not found in the above table are the same as those in the table on the previous page.

Dimensions of Servomotors with Batteryless Absolute Encoders

◆ Servomotors without Gears

Model SGM7P-	L	LL	Approx. Mass [kg]
01A6A2□	93 (123)	68 (98)	0.5 (0.9)
02A6A2□	105 (136.5)	75 (106.5)	1.2 (2.0)
04A6A2□	115 (146.5)	85 (116.5)	1.5 (2.3)
08A6A2□	134.5 (168)	94.5 (128)	4.3 (6.0)
15A6A2□	162.5 (195.5)	122.5 (155.5)	6.7 (8.3)

Note: The values in parentheses are for Servomotors with Holding Brakes.

◆ Servomotors with Gears

• Shaft End Specification: Straight

Model SGM7P-	L	LL	Approx. Mass [kg]
01A6AH1□□	149.5 (179.5)	107.5 (179.5)	0.9 (1.3)
01A6AHB□□	190 (220)	132 (162)	1.6 (2.0)
01A6AHC□□			3.4 (3.8)
01A6AH7□□	219 (249)	139 (169)	2.4 (3.0)
02A6AH1□□	198 (229.5)	140 (171.5)	2.4 (3.0)
02A6AHB□□			2.5 (3.1)
02A6AHC□□	233 (264.5)	153 (184.5)	4.3 (5.1)
02A6AH7□□			2.7 (3.3)
04A6AH1□□	208 (239.5)	150 (181.5)	4.6 (5.4)
04A6AHB□□	243 (274.5)	163 (194.5)	9.3 (10.1)
04A6AHC□□			7.0 (8.7)
04A6AH7□□	322 (354.5)	191 (220.5)	7.2 (8.9)
08A6AH1□□	261.5 (295)	181.5 (215)	12.1 (13.8)
08A6AHB□□			14.0 (15.6)
08A6AHC□□	334.5 (368)	201.5 (235)	14.5 (16.1)
08A6AH7□□			25.8 (27.4)
15A6AH1□□	362.5 (395.5)	229.5 (262.5)	22.8 (24.4)
15A6AHB□□			13.1 (14.7)
15A6AHC□□	401.5 (434.5)	245.5 (278.5)	22.8 (24.4)
15A6AH7□□			22.8 (24.4)

Note: The values in parentheses are for Servomotors with Holding Brakes.

• Shaft End Specification: Flange Output

Model SGM7P-	L	Approx. Mass [kg]
01A6AH10□	122.5 (152.5)	0.8 (1.2)
01A6AHB0□	153 (183)	1.5 (1.9)
01A6AHC0□		3.0 (3.4)
01A6AH70□	166 (196)	2.3 (2.9)
02A6AH10□	161 (192.5)	2.4 (3.0)
02A6AHB0□		3.9 (4.7)
02A6AHC0□	180 (211.5)	2.6 (3.2)
02A6AH70□		4.2 (5.0)
04A6AH10□	171 (202.5)	7.9 (8.7)
04A6AHB0□	190 (221.5)	6.6 (8.3)
04A6AHC0□		6.8 (8.5)
04A6AH70□	224 (255.5)	10.7 (12.4)
08A6AH10□	208.5 (242)	12.6 (14.2)
08A6AHB0□		13.1 (14.7)
08A6AHC0□	236.5 (270)	22.8 (24.4)
08A6AH70□		22.8 (24.4)
15A6AH10□	264.5 (297.5)	22.8 (24.4)
15A6AHB0□		22.8 (24.4)
15A6AHC0□	298.5 (331.5)	22.8 (24.4)
15A6AH70□		22.8 (24.4)

Selecting Cables

◆ Cable Configurations

The cables shown below are required to connect a Servomotor to a SERVOPACK.

Encoder Cable of 20 m or Less

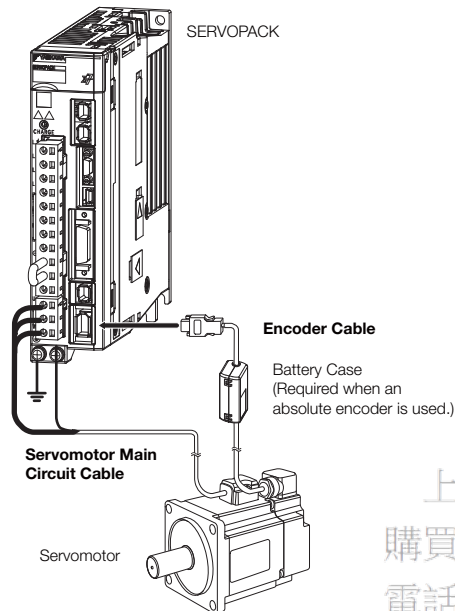

Encoder Cable of 30 m to 50 m (Relay Cable)

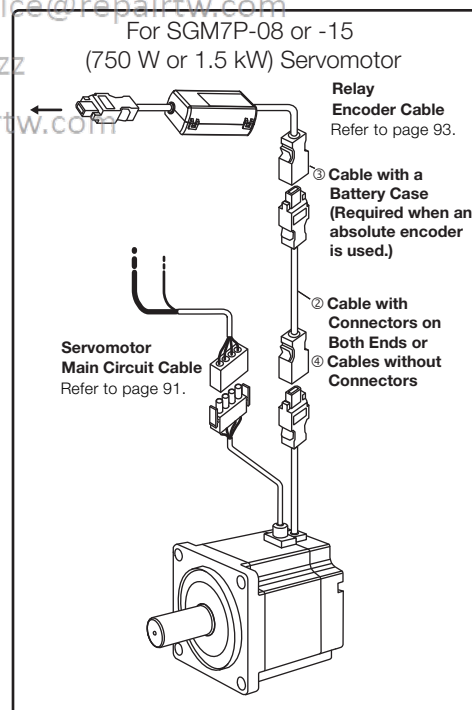
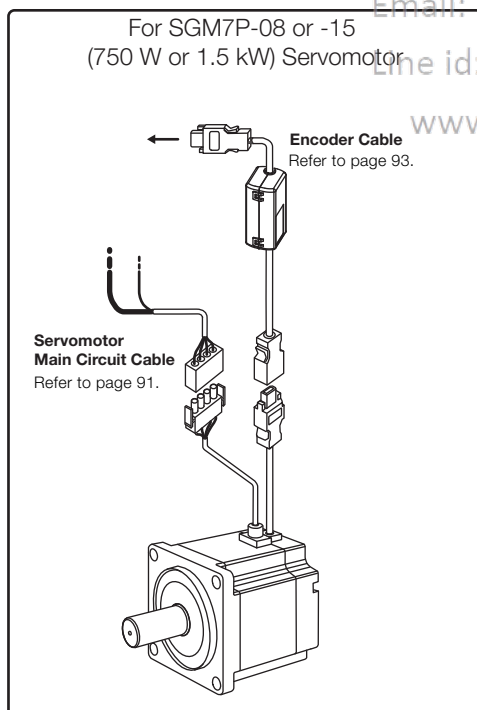
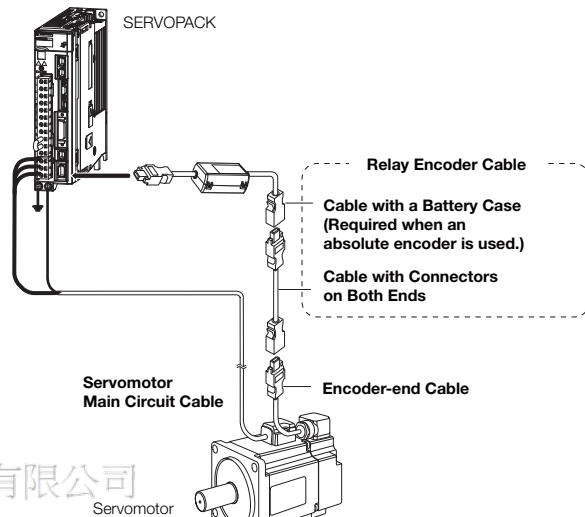

Note: 1. If the Encoder Cable length exceeds 20 m, be sure to use a Relay Encoder Cable.

2. If you use a Servomotor Main Circuit Cable that exceeds 20 m, the intermittent duty zone in the torque-motor speed characteristics will become smaller because the voltage drop increases.

3. Refer to the following manual for the following information.

- Cable dimensional drawings and cable connection specifications
- Order numbers and specifications of individual connectors for cables
- Order numbers and specifications for wiring materials

☞ Σ -7-Series AC Servo Drive Peripheral Device Selection Manual (Manual No.: SIEP S80001 32)

上正科技有限公司
購買、維修 此手冊零組件
電話： 037-466333
Email: service@repairtw.com
Line id: @zzzz
www.repairtw.com

◆ Servomotor Main Circuit Cables

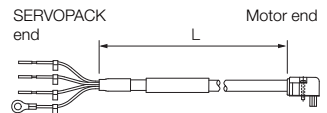
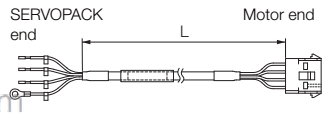
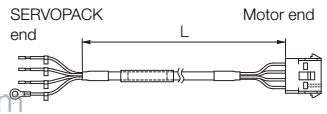
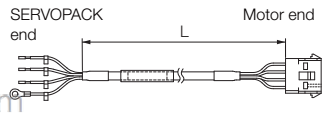
Servomotor Model	Name	Length (L)	Order Number		Appearance
			Standard Cable	Flexible Cable*	
SGM7P-01 100 W		3 m	JZSP-CSM01-03-E	JZSP-CSM21-03-E	
		5 m	JZSP-CSM01-05-E	JZSP-CSM21-05-E	
		10 m	JZSP-CSM01-10-E	JZSP-CSM21-10-E	
		15 m	JZSP-CSM01-15-E	JZSP-CSM21-15-E	
		20 m	JZSP-CSM01-20-E	JZSP-CSM21-20-E	
		30 m	JZSP-CSM01-30-E	JZSP-CSM21-30-E	
		40 m	JZSP-CSM01-40-E	JZSP-CSM21-40-E	
SGM7P-02 and -04 200 W, 400 W	For Servomotors without Holding Brakes	3 m	JZSP-CSM02-03-E	JZSP-CSM22-03-E	
		5 m	JZSP-CSM02-05-E	JZSP-CSM22-05-E	
		10 m	JZSP-CSM02-10-E	JZSP-CSM22-10-E	
		15 m	JZSP-CSM02-15-E	JZSP-CSM22-15-E	
		20 m	JZSP-CSM02-20-E	JZSP-CSM22-20-E	
		30 m	JZSP-CSM02-30-E	JZSP-CSM22-30-E	
		40 m	JZSP-CSM02-40-E	JZSP-CSM22-40-E	
SGM7P-08 750 W		3 m	JZSP-CMM00-03-E	JZSP-CMM01-03-E	
		5 m	JZSP-CMM00-05-E	JZSP-CMM01-05-E	
		10 m	JZSP-CMM00-10-E	JZSP-CMM01-10-E	
		15 m	JZSP-CMM00-15-E	JZSP-CMM01-15-E	
		20 m	JZSP-CMM00-20-E	JZSP-CMM01-20-E	
		30 m	JZSP-CMM00-30-E	JZSP-CMM01-30-E	
		40 m	JZSP-CMM00-40-E	JZSP-CMM01-40-E	
SGM7P-15 1.5 kW		3 m	JZSP-CMM20-03-E	—	
		5 m	JZSP-CMM20-05-E	—	
		10 m	JZSP-CMM20-10-E	—	
		15 m	JZSP-CMM20-15-E	—	
		20 m	JZSP-CMM20-20-E	—	

* Use Flexible Cables for moving parts of machines, such as robots. The recommended bending radius (R) is 90 mm or larger.

Rotary Servomotors
SGM7P

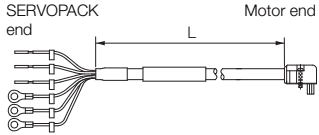
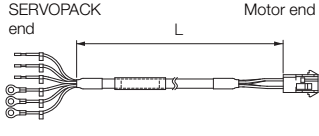
Servomotor Model	Name	Length (L)	Order Number		Appearance
			Standard Cable	Flexible Cable*	
SGM7P-01 100 W	For Servo- motors with Holding Brakes	3 m	JZSP-CSM11-03-E	JZSP-CSM31-03-E	
		5 m	JZSP-CSM11-05-E	JZSP-CSM31-05-E	
		10 m	JZSP-CSM11-10-E	JZSP-CSM31-10-E	
		15 m	JZSP-CSM11-15-E	JZSP-CSM31-15-E	
		20 m	JZSP-CSM11-20-E	JZSP-CSM31-20-E	
		30 m	JZSP-CSM11-30-E	JZSP-CSM31-30-E	
		40 m	JZSP-CSM11-40-E	JZSP-CSM31-40-E	
50 m		JZSP-CSM11-50-E	JZSP-CSM31-50-E		
SGM7P-02 and -04 200 W, 400 W		3 m	JZSP-CSM12-03-E	JZSP-CSM32-03-E	
		5 m	JZSP-CSM12-05-E	JZSP-CSM32-05-E	
		10 m	JZSP-CSM12-10-E	JZSP-CSM32-10-E	
		15 m	JZSP-CSM12-15-E	JZSP-CSM32-15-E	
		20 m	JZSP-CSM12-20-E	JZSP-CSM32-20-E	
		30 m	JZSP-CSM12-30-E	JZSP-CSM32-30-E	
	40 m	JZSP-CSM12-40-E	JZSP-CSM32-40-E		
SGM7P-08 750 W	3 m	JZSP-CMM10-03-E	JZSP-CMM11-03-E		
	5 m	JZSP-CMM10-05-E	JZSP-CMM11-05-E		
	10 m	JZSP-CMM10-10-E	JZSP-CMM11-10-E		
	15 m	JZSP-CMM10-15-E	JZSP-CMM11-15-E		
	20 m	JZSP-CMM10-20-E	JZSP-CMM11-20-E		
	30 m	JZSP-CMM10-30-E	JZSP-CMM11-30-E		
	40 m	JZSP-CMM10-40-E	JZSP-CMM11-40-E		
SGM7P-15 1.5 kW	3 m	JZSP-CMM30-03-E	—		
	5 m	JZSP-CMM30-05-E	—		
	10 m	JZSP-CMM30-10-E	—		
	15 m	JZSP-CMM30-15-E	—		
	20 m	JZSP-CMM30-20-E	—		

* Use Flexible Cables for moving parts of machines, such as robots. The recommended bending radius (R) is 90 mm or larger.

◆ Encoder Cables of 20 m or Less

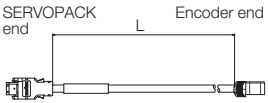
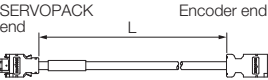
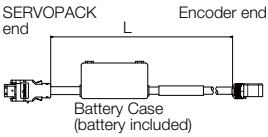
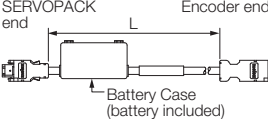
Servomotor Model	Name	Length (L)	Order Number		Appearance
			Standard Cable	Flexible Cable* ¹	
SGM7P-01, -02 and -04 100 W, 200 W, 400 W	For incremental encoder, or batteryless absolute encoder	3 m	JZSP-C7PI0D-03-E	JZSP-C7PI2D-03-E	
		5 m	JZSP-C7PI0D-05-E	JZSP-C7PI2D-05-E	
		10 m	JZSP-C7PI0D-10-E	JZSP-C7PI2D-10-E	
		15 m	JZSP-C7PI0D-15-E	JZSP-C7PI2D-15-E	
		20 m	JZSP-C7PI0D-20-E	JZSP-C7PI2D-20-E	
SGM7P-08 and -15 750 W, 1500 W	Cable installed toward load	3 m	JZSP-CMP00-03-E	JZSP-CMP10-03-E	
		5 m	JZSP-CMP00-05-E	JZSP-CMP10-05-E	
		10 m	JZSP-CMP00-10-E	JZSP-CMP10-10-E	
		20 m	JZSP-CMP00-20-E	JZSP-CMP10-20-E	
SGM7P-01, -02 and -04 100 W, 200 W, 400 W	For absolute encoder: With Battery Case* ²	3 m	JZSP-C7PA0D-03-E	JZSP-C7PA2D-03-E	
		5 m	JZSP-C7PA0D-05-E	JZSP-C7PA2D-05-E	
		10 m	JZSP-C7PA0D-10-E	JZSP-C7PA2D-10-E	
		15 m	JZSP-C7PA0D-15-E	JZSP-C7PA2D-15-E	
SGM7P-08 and -15 750 W, 1500 W	Cable installed toward load	3 m	JZSP-CSP19-03-E	JZSP-CSP29-03-E	
		5 m	JZSP-CSP19-05-E	JZSP-CSP29-05-E	
		10 m	JZSP-CSP19-10-E	JZSP-CSP29-10-E	
		20 m	JZSP-CSP19-20-E	JZSP-CSP29-20-E	

*1. Use Flexible Cables for moving parts of machines, such as robots. The recommended bending radius (R) is 90 mm or larger.

*2. If a battery is connected to the host controller, the Battery Case is not required. If so, use a cable for incremental encoders.

◆ Relay Encoder Cables of 30 m to 50 m

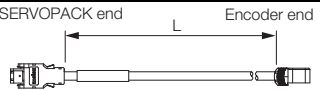
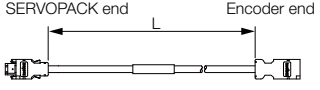
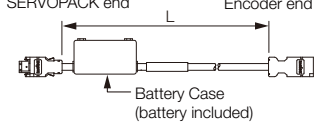
Servomotor Model	Name	Length (L)	Order Number	Appearance
All SGM7P models	Encoder-end Cable (for all types of encoders) Cable installed toward load	0.3 m	JZSP-C7PRCD-E	
	Cables with Connectors on Both Ends (for all types of encoders)	30 m	JZSP-UCMP00-30-E	
		40 m	JZSP-UCMP00-40-E	
		50 m	JZSP-UCMP00-50-E	
	Cable with a Battery Case (Required when an absolute encoder is used.*)	0.3 m	JZSP-CSP12-E	

* This Cable is not required if you use a Servomotor with a Batteryless Absolute Encoder, and you connect a battery to the host controller.

SGM7G

Model Designations

SGM7G - 03 A 7 A 2 1

1st+2nd digits 3rd digit 4th digit 5th digit 6th digit 7th digit

Σ-7 Series Servomotors: SGM7G

1st+2nd digits Rated Output

Code	Specification
03	300 W
05	450 W
09	850 W
13	1.3 kW
20	1.8 kW
30	2.9 kW*
44	4.4 kW
55	5.5 kW
75	7.5 kW
1A	11 kW
1E	15 kW

* The rated output is 2.4 kW if you combine the SGM7G-30A with the SGD7S-200A.

3rd digit Power Supply Voltage

Code	Specification
A	200 VAC

4th digit Serial Encoder

Code	Specification
6	24-bit batteryless absolute
7	24-bit absolute
F	24-bit incremental

5th digit Design Revision Order

A

6th digit Shaft End

Code	Specification
2	Straight without key
6	Straight with key and tap

7th digit Options

Code	Specification
1	Without options
C	With holding brake (24 VDC)
E	With oil seal and holding brake (24 VDC)
S	With oil seal

上正科技有限公司

購買、維修 此手冊零組件

電話： 037-466333

Email: service@repairtw.com

Line id: @zzzz

www.repairtw.com

Specifications and Ratings

Specifications

Voltage		200 V										
Model SGM7G-		03A	05A	09A	13A	20A	30A	44A	55A	75A	1AA	1EA
Time Rating		Continuous										
Thermal Class		UL: F, CE: F										
Insulation Resistance		500 VDC, 10 MΩ min.										
Withstand Voltage		1,500 VAC for 1 minute										
Excitation		Permanent magnet										
Mounting		Flange-mounted										
Drive Method		Direct drive										
Rotation Direction		Counterclockwise (CCW) for forward reference when viewed from the load side										
Vibration Class*1		V15										
Environmental Conditions	Surrounding Air Temperature	0°C to 40°C (60°C max.)*3										
	Surrounding Air Humidity	20% to 80% relative humidity (with no condensation)										
	Installation Site	<ul style="list-style-type: none"> • Must be indoors and free of corrosive and explosive gases. • Must be well-ventilated and free of dust and moisture. • Must facilitate inspection and cleaning. • Must have an altitude of 1,000 m or less. (With derating, usage is possible between 1,000 m and 2,000 m.)*3 • Must be free of strong magnetic fields. 										
	Storage Environment	Store the Servomotor in the following environment if you store it with the power cable disconnected. Storage Temperature: -20°C to 60°C (with no freezing) Storage Humidity: 20% to 80% relative humidity (with no condensation)										
Shock Resistance*2	Impact Acceleration Rate at Flange	490 m/s ²										
	Number of Impacts	2 times										
Vibration Resistance*2	Vibration Acceleration Rate at Flange	49 m/s ² (24.5 m/s ² front to back)							24.5 m/s ²			
Applicable SERVOPACKs	SGD7S-	3R8A	7R6A	120A	180A	330A	470A	550A	590A	780A		
	SGD7W- SGD7C-	5R5A*4, 7R6A*4	7A6A	-								

*1. A vibration class of V15 indicates a vibration amplitude of 15 μm maximum on the Servomotor without a load at the rated motor speed.

*2. The given values are for when the Servomotor shaft is mounted horizontally and shock or vibration is applied in the directions shown in the following figures.

The strength of the vibration that the Servomotor can withstand depends on the application. Always check the vibration acceleration rate that is applied to the Servomotor with the actual equipment.

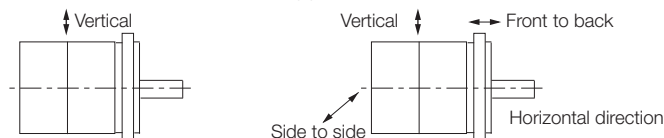

Shock Applied to the Servomotor

Vibration Applied to the Servomotor

*3. Refer to the following section for the derating rates.

Derating Rates (page 102)

*4. If you use a Servomotor together with a Σ-7W or Σ-7C SERVOPACK, the control gain may not increase as much as with a Σ-7S SERVOPACK and other performances may be lower than those achieved with a Σ-7S SERVOPACK.

Servomotor Ratings

Voltage		200 V					
Model SGM7G-		03A	05A	09A	13A	20A	
Rated Output* ¹	kW	0.3	0.45	0.85	1.3	1.8	
Rated Torque* ^{1, *2}	N·m	1.96	2.86	5.39	8.34	11.5	
Instantaneous Maximum Torque* ¹	N·m	5.88	8.92	14.2	23.3	28.7	
Rated Current* ¹	Arms	2.8	3.8	6.9	10.7	16.7	
Instantaneous Maximum Current* ¹	Arms	8.0	11	17	28	42	
Rated Motor Speed* ¹	min ⁻¹	1500					
Maximum Motor Speed* ¹	min ⁻¹	3000					
Torque Constant	N·m/Arms	0.776	0.854	0.859	0.891	0.748	
Motor Moment of Inertia	×10 ⁻⁴ kg·m ²	2.48 (2.73)	3.33 (3.58)	13.9 (16.0)	19.9 (22.0)	26.0 (28.1)	
Rated Power Rate* ¹	kW/s	15.5 (14.1)	24.6 (22.8)	20.9 (18.2)	35.0 (31.6)	50.9 (47.1)	
Rated Angular Acceleration Rate* ¹	rad/s ²	7900 (7180)	8590 (7990)	3880 (3370)	4190 (3790)	4420 (4090)	
Heat Sink Size* ³	mm	250 × 250 × 6 (aluminum)		400 × 400 × 20 (steel)			
Protective Structure* ⁴	Totally enclosed, self-cooled, IP67						
Holding Brake Specifications* ⁵	Rated Voltage	24 VDC ^{+10%} ₀					
	Capacity	10					
	Holding Torque	4.5	12.7		19.6		
	Coil Resistance	56			59		
	Rated Current	0.43			0.41		
	Time Required to Release Brake	100					
	Time Required to Brake	80					
Allowable Load Moment of Inertia (Motor Moment of Inertia Ratio)* ⁶	15 times			5 times			
	With External Regenerative Resistor and External Dynamic Brake Resistor	15 times			10 times		
Allowable Shaft Loads* ⁷	LF	40			58		
	Allowable Radial Load	490			686	980	
	Allowable Thrust Load	98			343	392	

Note: The values in parentheses are for Servomotors with Holding Brakes.

*1. These values are for operation in combination with a SERVOPACK when the temperature of the armature winding is 20°C. These are typical values.

*2. The rated torques are the continuous allowable torque values with an aluminum or steel heat sink of the dimensions given in the table.

*3. Refer to the following section for the relation between the heat sinks and derating rate.

 **Servomotor Heat Dissipation Conditions (page 102)**

*4. This does not apply to the shaft opening. Protective structure specifications apply only when the special cable is used.

*5. Observe the following precautions if you use a Servomotor with a Holding Brake.

- The holding brake cannot be used to stop the Servomotor.
- The time required to release the brake and the time required to brake depend on which discharge circuit is used. Confirm that the operation delay time is appropriate for the actual equipment.
- The 24-VDC power supply is not provided by Yaskawa.

*6. The motor moment of inertia scaling factor is the value for a standard Servomotor without a Holding Brake.

*7. Design the mechanical system so that the thrust and radial loads applied to the Servomotor shaft end during operation do not exceed the values given in the table.

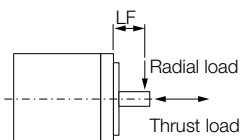

Torque-Motor Speed Characteristics

A : Continuous duty zone ——— (solid lines): With three-phase 200-V or single-phase 230-V input
B : Intermittent duty zone - - - - - (dotted lines): With single-phase 200-V input

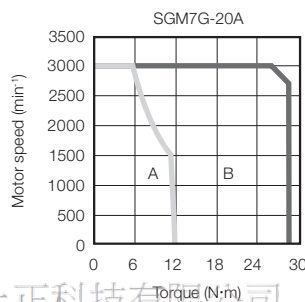
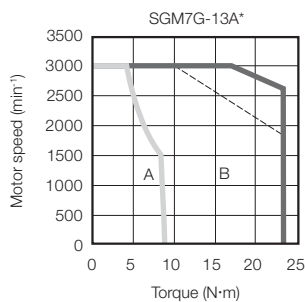
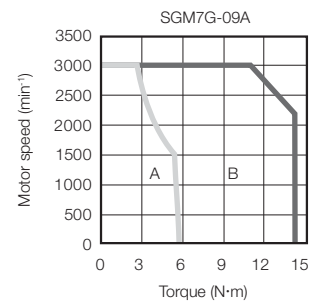
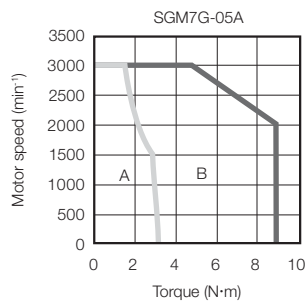
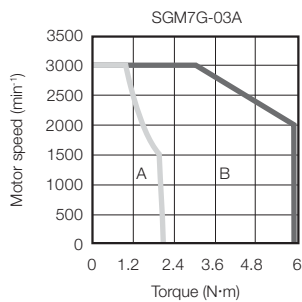

* A single-phase power input can be used in combination with the SGD7S-120A□□A008.

Note: 1. These values (typical values) are for operation in combination with a SERVOPACK when the temperature of the armature winding is 20°C.

2. The characteristics in the intermittent duty zone depend on the power supply voltage.
3. If the effective torque is within the allowable range for the rated torque, the Servomotor can be used within the intermittent duty zone.
4. If you use a Servomotor Main Circuit Cable that exceeds 20 m, the intermittent duty zone in the torque-motor speed characteristics will become smaller because the voltage drop increases.

www.repairtw.com

Servomotor Ratings

Voltage		200 V						
Model SGM7G-		30A	30A* ⁶	44A	55A	75A	1AA	1EA
Rated Output* ¹	kW	2.9	2.4	4.4	5.5	7.5	11	15
Rated Torque* ^{1, *2}	N·m	18.6	15.1	28.4	35.0	48.0	70.0	95.4
Instantaneous Maximum Torque* ¹	N·m	54.0	45.1	71.6	102	119	175	224
Rated Current* ¹	Arms	23.8	19.6	32.8	37.2	54.7	58.6	78.0
Instantaneous Maximum Current* ¹	Arms	70	56	84	110	130	140	170
Rated Motor Speed* ¹	min ⁻¹	1500	1500	1500	1500	1500	1500	1500
Maximum Motor Speed* ¹	min ⁻¹	3000	3000	3000	3000	3000	2000	2000
Torque Constant	N·m/Arms	0.848	0.848	0.934	1.00	0.957	1.38	1.44
Motor Moment of Inertia	×10 ⁻⁴ kg·m ²	46.0 (53.9)	46.0 (53.9)	67.5 (75.4)	89.0 (96.9)	125 (133)	242 (261)	303 (341)
Rated Power Rate* ¹	kW/s	75.2 (64.2)	49.5 (42.2)	119 (107)	138 (126)	184 (173)	202 (188)	300 (267)
Rated Angular Acceleration Rate* ¹	rad/s ²	4040 (3450)	3280 (2800)	4210 (3770)	3930 (3610)	3840 (3610)	2890 (2680)	3150 (2800)
Heat Sink Size* ³	mm	550 × 550 × 30 (steel)					650 × 650 × 35 (steel)	
Protective Structure* ⁴	Totally enclosed, self-cooled, IP67							
Holding Brake Specifications* ⁵	Rated Voltage	V	24 VDC ^{+10%} ₀					
	Capacity	W	18.5		25	32	35	
	Holding Torque	N·m	43.1		72.6	84.3	114.6	
	Coil Resistance	Ω (at 20°C)	33		23	18	17	
	Rated Current	A (at 20°C)	0.77		1.05	1.33	1.46	
	Time Required to Release Brake	ms	170					250
	Time Required to Brake	ms	100			80		
Allowable Load Moment of Inertia (Motor Moment of Inertia Ratio)* ⁶		5 times	3 times	5 times				
	With External Regenerative Resistor and External Dynamic Brake Resistor	10 times	7 times	10 times				
Allowable Shaft Loads* ⁷	LF	mm	79			113	116	
	Allowable Radial Load	N	1470			1764		4998
	Allowable Thrust Load	N	490			588		2156

Note: The values in parentheses are for Servomotors with Holding Brakes.

*1. These values are for operation in combination with a SERVOPACK when the temperature of the armature winding is 20°C. These are typical values.

*2. The rated torques are the continuous allowable torque values with an aluminum or steel heat sink of the dimensions given in the table.

*3. Refer to the following section for the relation between the heat sinks and derating rate.

 **Servomotor Heat Dissipation Conditions (page 102)**

*4. This does not apply to the shaft opening. Protective structure specifications apply only when the special cable is used.

*5. Observe the following precautions if you use a Servomotor with a Holding Brake.

- The holding brake cannot be used to stop the Servomotor.
- The time required to release the brake and the time required to brake depend on which discharge circuit is used. Confirm that the operation delay time is appropriate for the actual equipment.
- The 24-VDC power supply is not provided by Yaskawa.

*6. The motor moment of inertia scaling factor is the value for a standard Servomotor without a Holding Brake.

*7. Design the mechanical system so that the thrust and radial loads applied to the Servomotor shaft end during operation do not exceed the values given in the table.

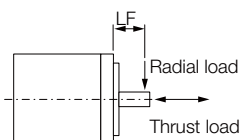

*8. This is the value if you combine the SGM7G-30A with the SGD7S-200A.

Torque-Motor Speed Characteristics

A : Continuous duty zone — (solid lines): With three-phase 200-V input
B : Intermittent duty zone - - - (dotted lines): When combined with the SGD7S-200A

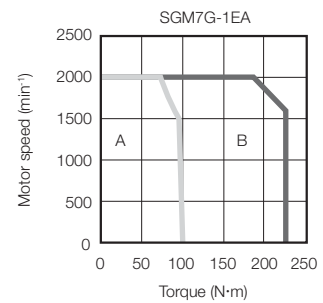
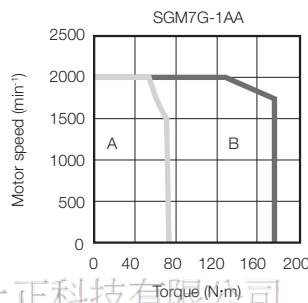
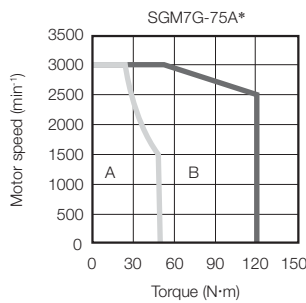
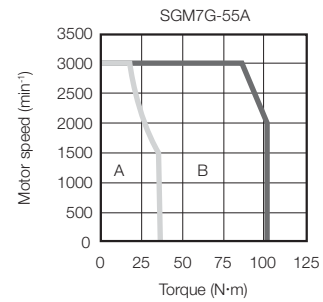
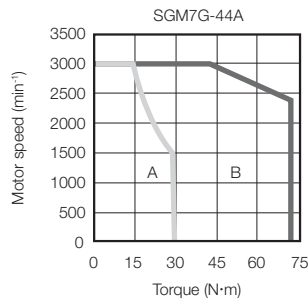
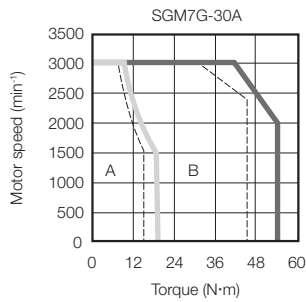

* Use an SGM7G-75A Servomotor with a Holding Brake with an output torque of 14.4 N·m (30% of the rated torque) or lower when using the Servomotor in continuous operation at the maximum motor speed of 3,000 min⁻¹.

Note: 1. These values (typical values) are for operation in combination with a SERVOPACK when the temperature of the armature winding is 20°C.

2. The characteristics in the intermittent duty zone depend on the power supply voltage.
3. If the effective torque is within the allowable range for the rated torque, the Servomotor can be used within the intermittent duty zone.
4. If you use a Servomotor Main Circuit Cable that exceeds 20 m, the intermittent duty zone in the torque-motor speed characteristics will become smaller because the voltage drop increases.

Servomotor Overload Protection Characteristics

The overload detection level is set for hot start conditions with a Servomotor surrounding air temperature of 40°C.

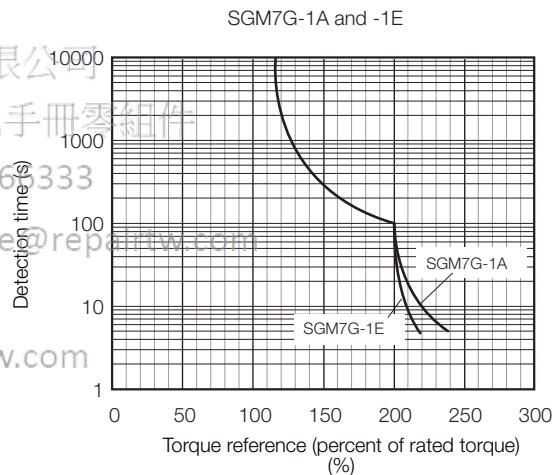
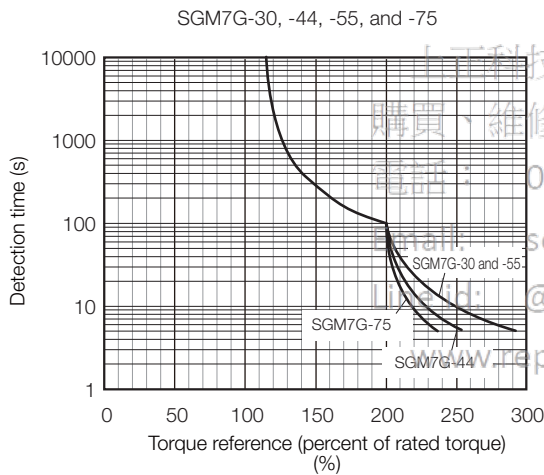
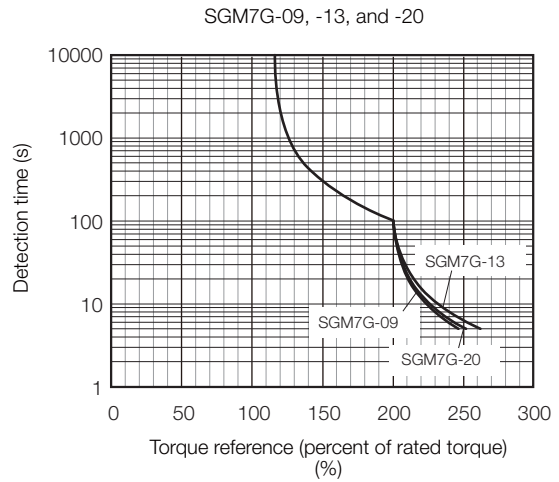
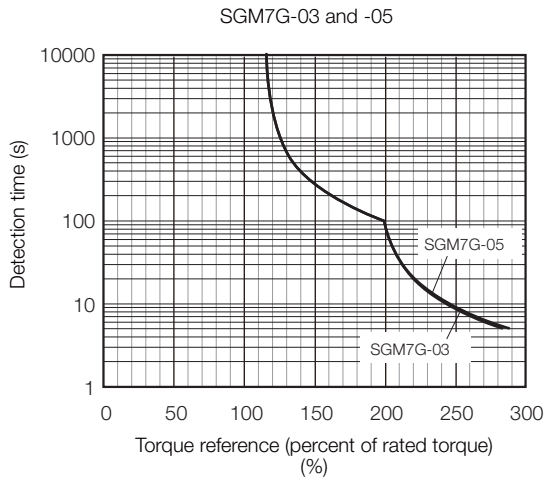

Note: The above overload protection characteristics do not mean that you can perform continuous duty operation with an output of 100% or higher. Use the Servomotor so that the effective torque remains within the continuous duty zone given in *Torque-Motor Speed Characteristics* on page 99.

Allowable Load Moment of Inertia

The allowable load moments of inertia (motor moment of inertia ratios) for the Servomotors are given in the *Servomotor Ratings* (pages 96 and 98). The values are determined by the regenerative energy processing capacity of the SERVOPACK and are also affected by the drive conditions of the Servomotor. Perform the required Steps for each of the following cases.

Use the SigmaSize+ AC Servo Drive Capacity Selection Program to check the driving conditions. Contact your Yaskawa representative for information on this program.

◆ Exceeding the Allowable Load Moment of Inertia

Use one of the following measures to adjust the load moment of inertia to within the allowable value.

- Reduce the torque limit.
- Reduce the deceleration rate.
- Reduce the maximum motor speed.

If the above steps is not possible, install an external regenerative resistor.

Information

An Overvoltage Alarm (A.400) is likely to occur during deceleration if the load moment of inertia exceeds the allowable load moment of inertia. SERVOPACKs with a built-in regenerative resistor may generate a Regenerative Overload Alarm (A.320). Refer to *Built-In Regenerative Resistor* (page 472) for the regenerative power (W) that can be processed by the SERVO-PACKs.

Install an External Regenerative Resistor when the built-in regenerative resistor cannot process all of the regenerative power.

◆ When an External Regenerative Resistor Is Required

Install the External Regenerative Resistor. Refer to the following section for the recommended products.

 *External Regenerative Resistors* (page 472)

王正科技有限公司

購買、維修 此手冊零組件

電話： 037-466333

Email: service@repairtw.com

Line id: @zzzz

www.repairtw.com

Derating Rates

◆ Servomotor Heat Dissipation Conditions

The Servomotor ratings are the continuous allowable values when a heat sink is installed on the Servomotor. If the Servomotor is mounted on a small device component, the Servomotor temperature may rise considerably because the surface for heat dissipation becomes smaller. Refer to the following graphs for the relation between the heat sink size and derating rate.

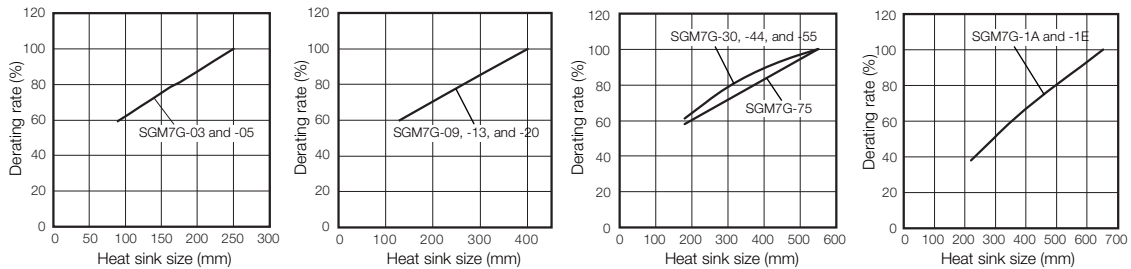

Important

The actual temperature rise depends on how the heat sink (i.e., the Servomotor mounting section) is attached to the installation surface, what material is used for the Servomotor mounting section, and the motor speed. Always check the Servomotor temperature with the actual equipment.

◆ Servomotor Derating Rates for Surrounding Air Temperatures

Apply a suitable derating rate from the following graphs according to the surrounding air temperature of the Servomotor (60°C max.).

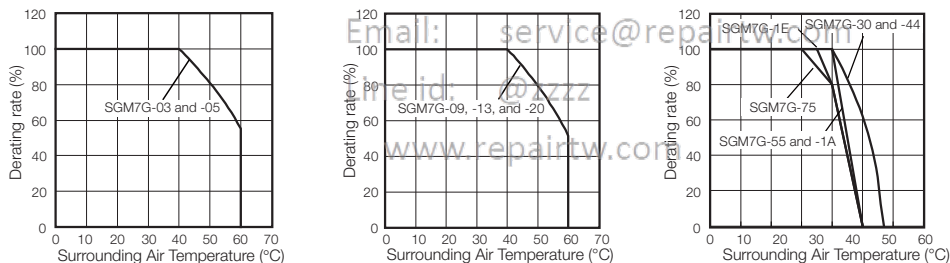

◆ Applications Where the Altitude Exceeds 1,000 m

The Servomotor ratings are the continuous allowable values at an altitude of 1,000 m or less. If you use a Servomotor at an altitude that exceeds 1,000 m (2,000 m max.), the heat dissipation effect of the air is reduced. Apply the appropriate derating rate from the following graphs.

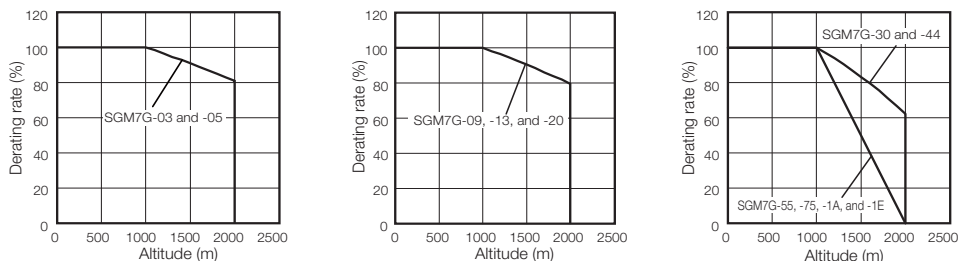

Information

When using Servomotors with derating, change the detection timing of overload warning and overload alarm based on the overload detection level of the motor given in *Servomotor Overload Protection Characteristics* (page 100).

Note: 1. Use the combination of the SERVOPACK and Servomotor so that the derating conditions are satisfied for both the SERVOPACK and Servomotor.

2. The derating rates are applicable only when the average motor speed is less than or equal to the rated motor speed. If the average motor speed exceeds the rated motor speed, consult with your Yaskawa representative.

External Dimensions

Servomotors without Holding Brakes

◆ SGM7G-03 and -05

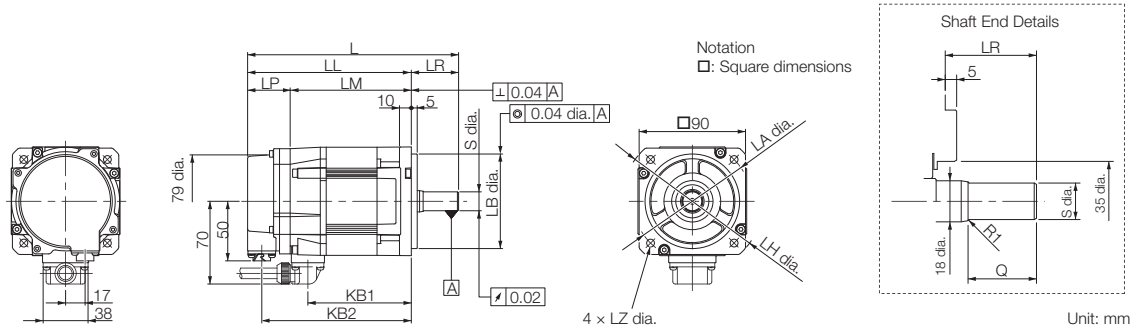

Model SGM7G-	L*1	LL*1	LM	LP*1	LR	KB1	KB2*1	KL1
03A□A21	166*2	126	90	36	40*2	75	114	70
05A□A21	179	139	103	36	40	88	127	70

Model SGM7G-	Flange Dimensions						Shaft End Dimensions		Approx. Mass [kg]	
	LA	LB	LC	LE	LG	LH	LZ	S		Q
03A□A21	100	80 ⁰ _{-0.030}	90	5	10	120	6.6	16 ⁰ _{-0.011} *2	30*2	2.6
05A□A21	100	80 ⁰ _{-0.030}	90	5	10	120	6.6	16 ⁰ _{-0.011}	30	3.2

*1. For models that have a batteryless absolute encoder, L, LL, LP, and KB2 are 8 mm greater than the given value. Refer to the following section for the values for individual models.

☞ *Dimensions of Servomotors with Batteryless Absolute Encoders* (page 109)

*2. The L, LR, S, and Q dimensions of these Servomotors are different from those of the Σ-V-series SGMGV Servomotors.

Models that have the same installation dimensions as the SGMGV Servomotors are also available. Contact your Yaskawa representative for details.

Note: 1. The values in parentheses are for Servomotors with Holding Brakes.

2. The values for a straight, without key specification are given. Refer to the information given below for other shaft end specifications and option specifications.

■ Shaft End Specifications

• Straight with Key and Tap

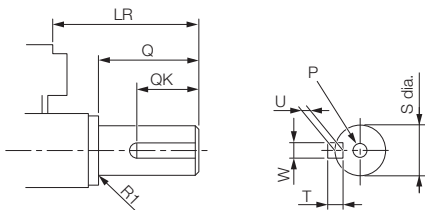

Model SGM7G-	LR	Q	QK	S	W	T	U	P
03A□A61	40*	30*	20*	16 ⁰ _{-0.011} *	5	5	3	M5×12L
05A□A61	40	30	20	16 ⁰ _{-0.011}	5	5	3	

* The shaft end dimensions of these Servomotors are different from those of the Σ-V-series SGMGV Servomotors.

Models that have the same installation dimensions as the SGMGV Servomotors are also available. Contact your Yaskawa representative for details.

■ Connector Specifications

• Encoder Connector (24-bit Encoder)

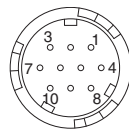

1	PS	6*	BAT(+)
2	/PS	7	-
3	-	8	-
4	PG5V	9	PG0V
5*	BAT(-)	10	FG (frame ground)

* A battery is required only for an absolute encoder.

Receptacle: CM10-R10P-D

Applicable plug: Not provided by Yaskawa.

Plug: CM10-AP10S-□-D for Right-angle Plug

CM10-SP10S-□-D for Straight Plug

(□ depends on the applicable cable size.)

Manufacturer: DDK Ltd.

• Servomotor Connector

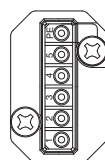

PE	FG (frame ground)	3	Phase U
5	-	2	Phase V
4	-	1	Phase W

Manufacturer: Japan Aviation Electronics Industry, Ltd.

◆ SGM7G-09 to -75

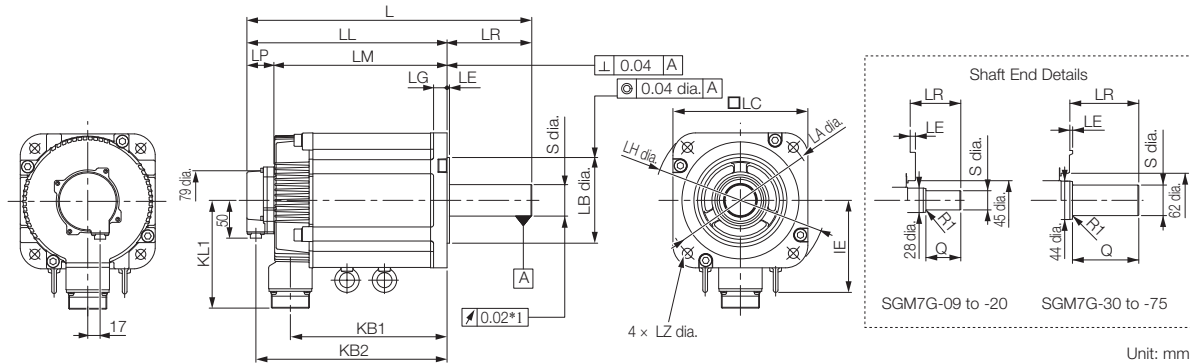

Unit: mm

Model SGM7G-	L*2	LL*2	LM	LP*2	LR	KB1	KB2*2	IE	KL1	Flange Dimensions						Shaft End Dimensions		Approx. Mass [kg]	
										LA	LB	LC	LE	LG	LH	LZ	S		Q
09A□A21	195	137	101	36	58	83	125	-	104	145	110 ⁰ _{-0.035}	130	6	12	165	9	24 ⁰ _{-0.013} *3	40	5.5
13A□A21	211	153	117	36	58	99	141	-	104	145	110 ⁰ _{-0.035}	130	6	12	165	9	24 ⁰ _{-0.013} *3	40	7.1
20A□A21	229	171	135	36	58	117	159	-	104	145	110 ⁰ _{-0.035}	130	6	12	165	9	24 ⁰ _{-0.013}	40	8.6
30A□A21	239	160	124	36	79	108	148	-	134	200	114.3 ⁰ _{-0.025}	180	3.2	18	230	13.5	35 ^{+0.01} ₀	76	13.5
44A□A21	263	184	148	36	79	132	172	-	134	200	114.3 ⁰ _{-0.025}	180	3.2	18	230	13.5	35 ^{+0.01} ₀	76	17.5
55A□A21	334	221	185	36	113	163	209	123	144	200	114.3 ⁰ _{-0.025}	180	3.2	18	230	13.5	42 ⁰ _{-0.016}	110	21.5
75A□A21	380	267	231	36	113	209	255	123	144	200	114.3 ⁰ _{-0.025}	180	3.2	18	230	13.5	42 ⁰ _{-0.016}	110	29.5

- *1. This is 0.04 for the SGM7G-55 or SGM7G-75.
- *2. For models that have a batteryless absolute encoder, L, LL, LP, and KB2 are 8 mm greater than the given value. Refer to the following section for the values for individual models.
Dimensions of Servomotors with Batteryless Absolute Encoders (page 109)
- *3. The S dimensions of these Servomotors are different from those of the Σ-V-series SGMGV Servomotors. Models that have the same installation dimensions as the SGMGV Servomotors are also available. Contact your Yaskawa representative for details.

Note: 1. The values in parentheses are for Servomotors with Holding Brakes.
 2. The values for a straight, without key specification are given. Refer to the information given below for other shaft end specifications and option specifications.

■ Shaft End Specifications
 • Straight with Key and Tap

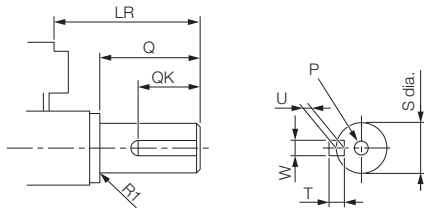

Model SGM7G-	LR	Q	QK	S	W	T	U	P
09A□A61	58	40	25	24 ⁰ _{-0.013} *	8*	7*	4*	M5×12L
13A□A61	58	40	25	24 ⁰ _{-0.013} *	8*	7*	4*	
20A□A61	58	40	25	24 ⁰ _{-0.013}	8	7	4	
30A□A61	79	76	60	35 ^{+0.01} ₀	10	8	5	M12×25L
44A□A61	79	76	60	35 ^{+0.01} ₀	10	8	5	
55A□A61	113	110	90	42 ⁰ _{-0.016}	12	8	5	M16×32L
75A□A61	113	110	90	42 ⁰ _{-0.016}	12	8	5	

* The shaft end dimensions of these Servomotors are different from those of the Σ-V-series SGMGV Servomotors. Models that have the same installation dimensions as the SGMGV Servomotors are also available. Contact your Yaskawa representative for details.

■ Connector Specifications

• Encoder Connector (24-bit Encoder)

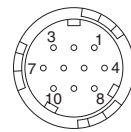

Pin	Signal	Pin	Signal
1	PS	6*	BAT(+)
2	/PS	7	-
3	-	8	-
4	PG5V	9	PG0V
5*	BAT(-)	10	FG (frame ground)

* A battery is required only for an absolute encoder.
 Receptacle: CM10-R10P-D
 Applicable plug: Not provided by Yaskawa.
 Plug: CM10-AP10S-□-D for Right-angle Plug
 CM10-SP10S-□-D for Straight Plug
 (□ depends on the applicable cable size.)
 Manufacturer: DDK Ltd.

• Servomotor Connector

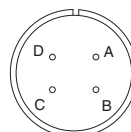

Terminal	Signal	Terminal	Signal
A	Phase U	C	Phase W
B	Phase V	D	FG (frame ground)

Manufacturer: DDK Ltd.

◆ SGM7G-1A and -1E

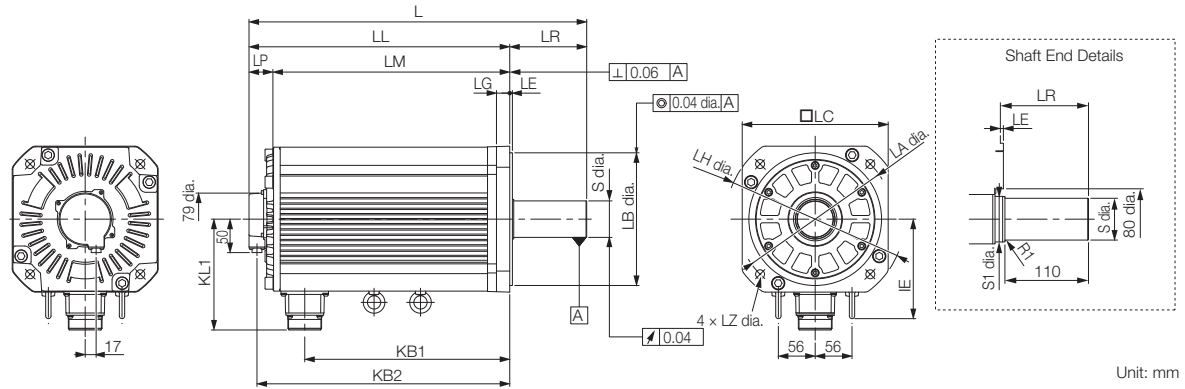

Model SGM7G-	L*	LL*	LM	LP*	LR	KB1	KB2*	IE	KL1	Flange Dimensions						Shaft End Dimensions		Approx. Mass [kg]	
										LA	LB	LC	LE	LG	LH	LZ	S		S1
1AA□A21	447	331	295	36	116	247	319	150	168	235	200 ⁰ _{-0.046}	220	4	20	270	13.5	42 ⁰ _{-0.016}	50	57
1EA□A21	509	393	357	36	116	309	381	150	168	235	200 ⁰ _{-0.046}	220	4	20	270	13.5	55 ^{+0.030} _{+0.011}	60	67

* For models that have a batteryless absolute encoder, L, LL, LP, and KB2 are 8 mm greater than the given value. Refer to the following section for the values for individual models.

📖 **Dimensions of Servomotors with Batteryless Absolute Encoders (page 109)**

Note: 1. The values in parentheses are for Servomotors with Holding Brakes.

2. The values for a straight, without key specification are given. Refer to the information given below for other shaft end specifications and option specifications.

■ Shaft End Specifications

• Straight with Key and Tap

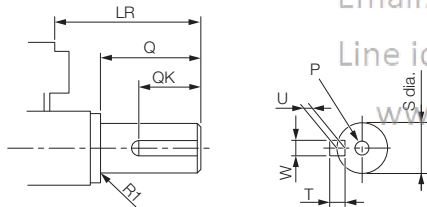

Model SGM7G-	LR	Q	QK	S	W	T	U	P
1AA□A61	116	110	90	42 ⁰ _{-0.016}	12	8	5	M16×32L
1EA□A61	116	110	90	55 ^{+0.030} _{+0.011}	16	10	6	M20×40L

■ Connector Specifications

• Encoder Connector (24-bit Encoder)

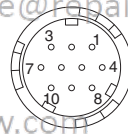

Pin	Signal	Pin	Signal
1	PS	6*	BAT(+)
2	/PS	7	-
3	-	8	-
4	PG5V	9	PG0V
5*	BAT(-)	10	FG (frame ground)

* A battery is required only for an absolute encoder.
Receptacle: CM10-R10P-D
Applicable plug: Not provided by Yaskawa.
Plug: CM10-AP10S-□-D for Right-angle Plug
CM10-SP10S-□-D for Straight Plug
(□ depends on the applicable cable size.)
Manufacturer: DDK Ltd.

• Servomotor Connector

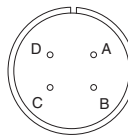

Terminal	Signal	Terminal	Signal
A	Phase U	C	Phase W
B	Phase V	D	FG (frame ground)

Manufacturer: DDK Ltd.

Servomotors with Holding Brakes

◆ SGM7G-03 and -05

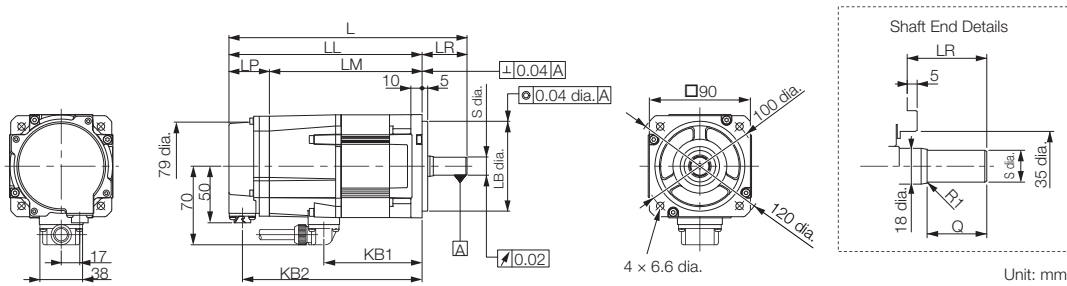

Model SGM7G-	L*1	LL*1	LM	LP*1	LR	KB1	KB2*1	KL1
03A□A2C	199*2	159	123	36	40*2	75	147	70
05A□A2C	212	172	136	36	40	88	160	70

Model SGM7G-	Flange Dimensions							Shaft End Dimensions		Approx. Mass [kg]
	LA	LB	LC	LE	LG	LH	LZ	S	Q	
03A□A2C	100	80 ⁰ _{-0.030}	90	5	10	120	6.6	16 ⁰ _{-0.011} *2	30*2	3.6
05A□A2C	100	80 ⁰ _{-0.030}	90	5	10	120	6.6	16 ⁰ _{-0.011}	30	4.2

*1. For models that have a batteryless absolute encoder, L, LL, LP, and KB2 are 8 mm greater than the given value. Refer to the following section for the values for individual models.

☞ *Dimensions of Servomotors with Batteryless Absolute Encoders* (page 109)

*2. The L, LR, S, and Q dimensions of these Servomotors are different from those of the Σ-V-series SGMGV Servomotors.

Models that have the same installation dimensions as the SGMGV Servomotors are also available. Contact your Yaskawa representative for details.

Note: 1. The values in parentheses are for Servomotors with Holding Brakes.

2. The values for a straight, without key specification are given. Refer to the information given below for other shaft end specifications and option specifications.

■ Shaft End Specifications

• Straight with Key and Tap

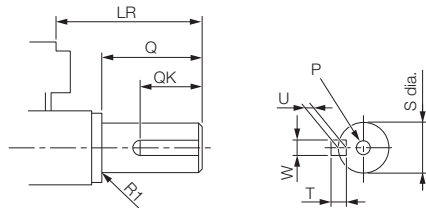

Model SGM7G-	LR	Q	QK	S	W	T	U	P
03A□A6C	40*	30*	20*	16 ⁰ _{-0.011} *	5	5	3	M5×12L
05A□A6C	40	30	20	16 ⁰ _{-0.011}	5	5	3	

* The shaft end dimensions of these Servomotors are different from those of the Σ-V-series SGMGV Servomotors.

Models that have the same installation dimensions as the SGMGV Servomotors are also available. Contact your Yaskawa representative for details.

■ Connector Specifications

• Encoder Connector (24-bit Encoder)

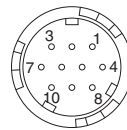

1	PS	6*	BAT(+)
2	/PS	7	-
3	-	8	-
4	PG5V	9	PG0V
5*	BAT(-)	10	FG (frame ground)

* A battery is required only for an absolute encoder.

Receptacle: CM10-R10P-D

Applicable plug: Not provided by Yaskawa.

Plug: CM10-AP10S-□-D for Right-angle Plug

CM10-SP10S-□-D for Straight Plug

(□ depends on the applicable cable size.)

Manufacturer: DDK Ltd.

• Servomotor Connector

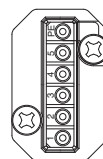

PE	FG (frame ground)	3	Phase U
5	-	2	Phase V
4	-	1	Phase W

Manufacturer: Japan Aviation Electronics Industry, Ltd.

◆ SGM7G-09 to -75

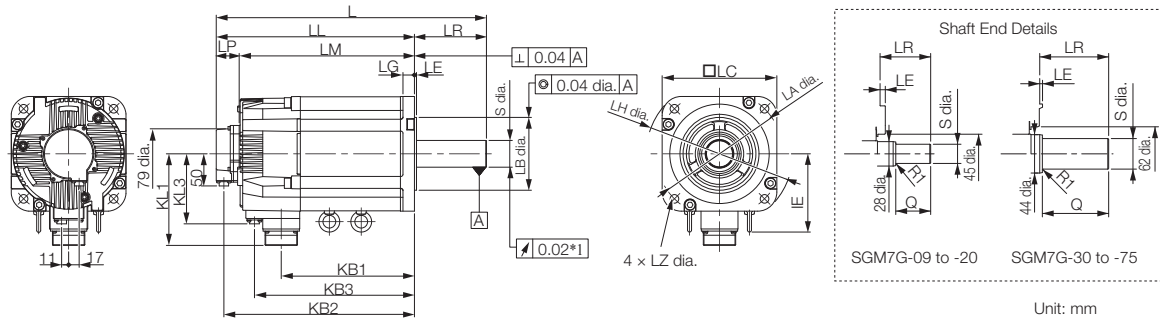

Model SGM7G-	L ^{*2}	LL ^{*2}	LM	LP ^{*2}	LR	KB1	KB2 ^{*2}	KB3	IE	KL1	KL3	Flange Dimensions						Shaft End Dimensions		Approx. Mass [kg]	
												LA	LB	LC	LE	LG	LH	LZ	S		Q
09A□A2C	231	173	137	36	58	83	161	115	-	104	80	145	110 ⁰ _{-0.035}	130	6	12	165	9	24 ⁰ _{-0.013} ^{*3}	40	7.5
13A□A2C	247	189	153	36	58	99	177	131	-	104	80	145	110 ⁰ _{-0.035}	130	6	12	165	9	24 ⁰ _{-0.013} ^{*3}	40	9.0
20A□A2C	265	207	171	36	58	117	195	149	-	104	80	145	110 ⁰ _{-0.035}	130	6	12	165	9	24 ⁰ _{-0.013}	40	11.0
30A□A2C	287	208	172	36	79	108	196	148	-	134	110	200	114.3 ⁰ _{-0.025}	180	3.2	18	230	13.5	35 ^{+0.01} ₀	76	19.5
44A□A2C	311	232	196	36	79	132	220	172	-	134	110	200	114.3 ⁰ _{-0.025}	180	3.2	18	230	13.5	35 ^{+0.01} ₀	76	23.5
55A□A2C	378	265	229	36	113	163	253	205	123	144	110	200	114.3 ⁰ _{-0.025}	180	3.2	18	230	13.5	42 ⁰ _{-0.016}	110	27.5
75A□A2C	424	311	275	36	113	209	299	251	123	144	110	200	114.3 ⁰ _{-0.025}	180	3.2	18	230	13.5	42 ⁰ _{-0.016}	110	35.0

- *1. This is 0.04 for the SGM7G-55 or SGM7G-75.
 - *2. For models that have a batteryless absolute encoder, L, LL, LP, and KB2 are 8 mm greater than the given value. Refer to the following section for the values for individual models.
 - Dimensions of Servomotors with Batteryless Absolute Encoders (page 109)**
 - *3. The S dimensions of these Servomotors are different from those of the Σ-V-series SGMGV Servomotors. Models that have the same installation dimensions as the SGMGV Servomotors are also available. Contact your Yaskawa representative for details.
- Note: 1. The values in parentheses are for Servomotors with Holding Brakes.
2. The values for a straight, without key specification are given. Refer to the information given below for other shaft end specifications and option specifications.

■ Shaft End Specifications

• Straight with Key and Tap

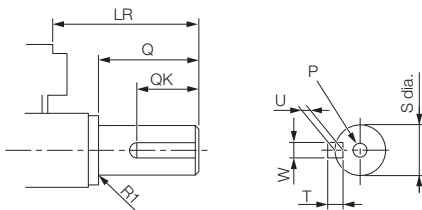

Model SGM7G-	LR	Q	QK	S	W	T	U	P
09A□A6C	58	40	25	24 ⁰ _{-0.013} [*]	8*	7*	4*	M5×12L
13A□A6C	58	40	25	24 ⁰ _{-0.013} [*]	8*	7*	4*	
20A□A6C	58	40	25	24 ⁰ _{-0.013}	8	7	4	
30A□A6C	79	76	60	35 ^{+0.01} ₀	10	8	5	M12×25L
44A□A6C	79	76	60	35 ^{+0.01} ₀	10	8	5	
55A□A6C	113	110	90	42 ⁰ _{-0.016}	12	8	5	M16×32L
75A□A6C	113	110	90	42 ⁰ _{-0.016}	12	8	5	

* The shaft end dimensions of these Servomotors are different from those of the Σ-V-series SGMGV Servomotors. Models that have the same installation dimensions as the SGMGV Servomotors are also available. Contact your Yaskawa representative for details.

■ Connector Specifications

• Encoder Connector (24-bit Encoder)

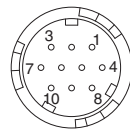

1	PS	6*	BAT(+)
2	/PS	7	-
3	-	8	-
4	PG5V	9	PG0V
5*	BAT(-)	10	FG (frame ground)

* A battery is required only for an absolute encoder.
Receptacle: CM10-R10P-D
Applicable plug: Not provided by Yaskawa.
Plug: CM10-AP10S-□-D for Right-angle Plug
CM10-SP10S-□-D for Straight Plug
(□ depends on the applicable cable size.)
Manufacturer: DDK Ltd.

• Servomotor Connector

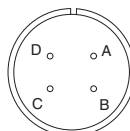

A	Phase U	C	Phase W
B	Phase V	D	FG (frame ground)

Manufacturer: DDK Ltd.

• Brake Connector

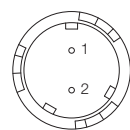

1	Brake terminal
2	Brake terminal

Note: There is no voltage polarity for the brake terminals.
Receptacle: CM10-R10P-D
Applicable plug: Not provided by Yaskawa.
Plug: CM10-AP2S-□-D for Right-angle Plug
CM10-SP2S-□-D for Straight Plug
(□ depends on the applicable cable size.)
Manufacturer: DDK Ltd.

◆ SGM7G-1A, 1E

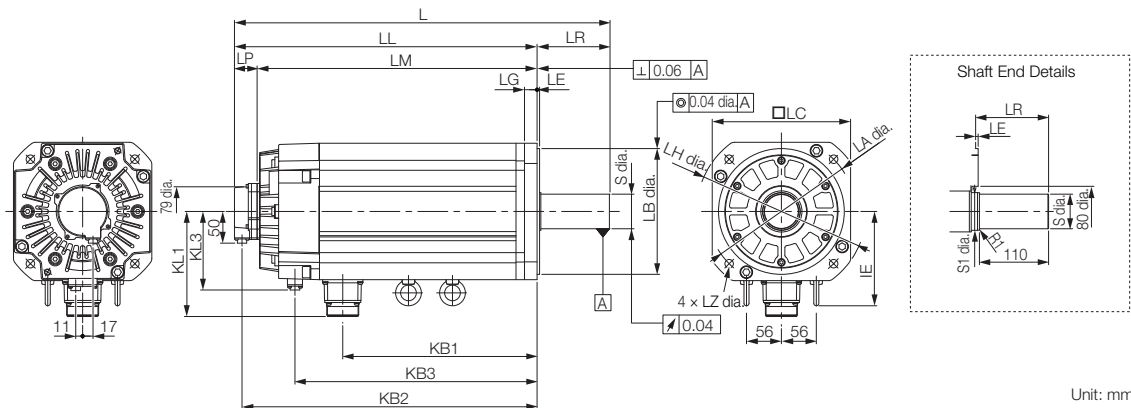

Unit: mm

Model SGM7G-	L*	LL*	LM	LP*	LR	KB1	KB2*	KB3	IE	KL1	KL3	Flange Dimensions						Shaft End Dimensions		Approx. Mass [kg]	
												LA	LB	LC	LE	LG	LH	LZ	S		S1
1AA□A2C	498	382	346	36	116	247	370	315	150	168	125	235	200 ⁰ _{-0.046}	220	4	20	270	13.5	42 ⁰ _{-0.016}	50	65
1EA□A2C	598	482	446	36	116	309	470	385	150	168	125	235	200 ⁰ _{-0.046}	220	4	20	270	13.5	55 ^{+0.030} _{+0.011}	60	85

* For models that have a batteryless absolute encoder, L, LL, LP, and KB2 are 8 mm greater than the given value. Refer to the following section for the values for individual models.

📖 **Dimensions of Servomotors with Batteryless Absolute Encoders (page 109)**

Note: 1. The values in parentheses are for Servomotors with Brakes.

2. The values for a straight, without key specification are given. Refer to the information given below for other shaft end specifications and option specifications.

■ Shaft End Specifications

- Straight with Key and Tap

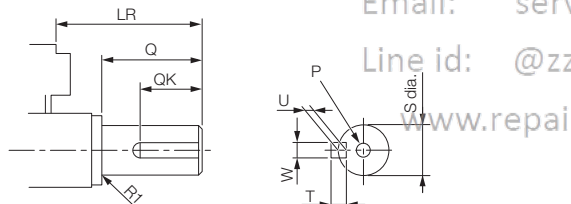

Model SGM7G-	LR	Q	QK	S	W	T	U	P
1AA□A6C	116	110	90	42 ⁰ _{-0.016}	12	8	5	M16×32L
1EA□A6C	116	110	90	55 ^{+0.030} _{+0.011}	16	10	6	M20×40L

■ Connector Specifications

- Encoder Connector (24-bit Encoder)



Terminal	Signal	Terminal	Signal
1	PS	6*	BAT(+)
2	/PS	7	-
3	-	8	-
4	PG5V	9	PG0V
5*	BAT(-)	10	FG (frame ground)

* A battery is required only for an absolute encoder.

Receptacle: CM10-R10P-D

Applicable plug: Not provided by Yaskawa.

Plug: CM10-AP10S-□-D for Right-angle Plug

CM10-SP10S-□-D for Straight Plug

(□ depends on the applicable cable size.)

Manufacturer: DDK Ltd.

- Servomotor Connector

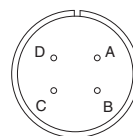

Terminal	Signal	Terminal	Signal
A	Phase U	C	Phase W
B	Phase V	D	FG (frame ground)

Manufacturer: DDK Ltd.

- Brake Connector

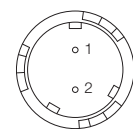

Terminal	Signal
1	Brake terminal
2	Brake terminal

Note: There is no voltage polarity for the brake terminals.

Receptacle: CM10-R10P-D

Applicable plug: Not provided by Yaskawa.

Plug: CM10-AP2S-□-D for Right-angle Plug

CM10-SP2S-□-D for Straight Plug

(□ depends on the applicable cable size.)

Manufacturer: DDK Ltd.

Dimensions of Servomotors with Batteryless Absolute Encoders

◆ Servomotors without Holding Brakes

Model SGM7G-	L	LL	LP	KB2	Approx. Mass [kg]
03A6A21	174	134	44	122	2.6
05A6A21	187	147	44	135	3.2
09A6A21	203	145	44	133	5.5
13A6A21	219	161	44	149	7.1
20A6A21	237	179	44	167	8.6
30A6A21	247	168	44	156	13.5
44A6A21	271	192	44	180	17.5
55A6A21	342	229	44	217	21.5
75A6A21	388	275	44	263	29.5
1AA6A21	455	339	44	327	57
1EA6A21	514	401	44	389	67

◆ Servomotors with Holding Brakes

Model SGM7G-	L	LL	LP	KB2	Approx. Mass [kg]
03A6A2C	207	167	44	155	3.6
05A6A2C	220	180	44	168	4.2
09A6A2C	239	181	44	169	7.5
13A6A2C	255	197	44	185	9.0
20A6A2C	273	215	44	203	11
30A6A2C	295	216	44	204	19.5
44A6A2C	319	240	44	228	23.5
55A6A2C	386	273	44	261	27.5
75A6A2C	432	319	44	307	35.0
1AA6A2C	506	390	44	378	65
1EA6A2C	606	490	44	478	85

Selecting Cables

◆ Cable Configurations

The cables shown below are required to connect a Servomotor to a SERVOPACK.

Encoder Cable of 20 m or Less

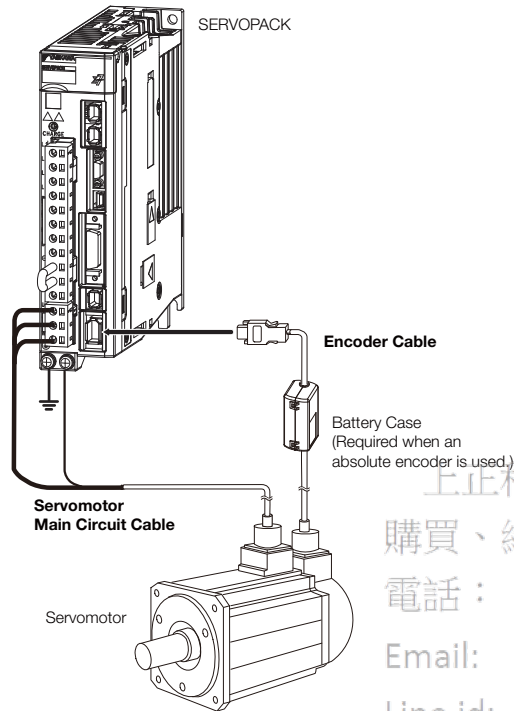

Encoder Cable of 30 m to 50 m (Relay Cable)

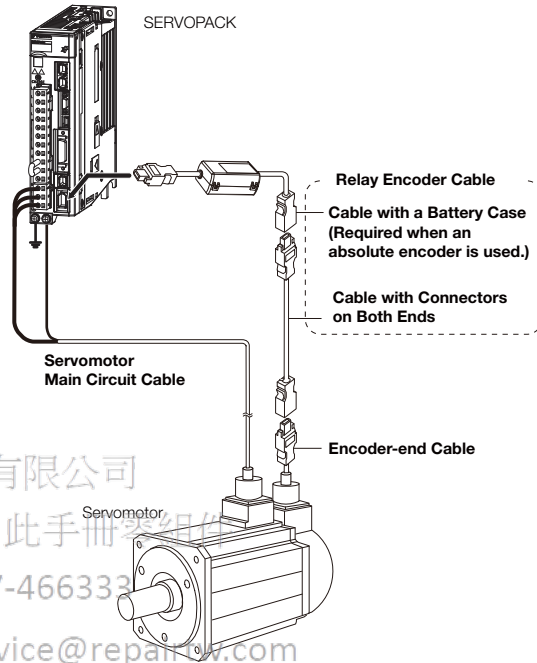

Note: 1. Cables with connectors on both ends that are compliant with an IP67 protective structure and European Safety Standards are not available from Yaskawa for the SGM7G Servomotors. You must make such a cable yourself. Use the Connectors specified by Yaskawa for these Servomotors. (These Connectors are compliant with the standards.) Yaskawa does not specify what wiring materials to use.

2. If the Encoder Cable length exceeds 20 m, be sure to use a Relay Encoder Cable.

3. If you use a Servomotor Main Circuit Cable that exceeds 20 m, the intermittent duty zone in the torque-motor speed characteristics will become smaller because the voltage drop increases.

4. Refer to the following manual for the following information.

- Cable dimensional drawings and cable connection specifications
- Order numbers and specifications of individual connectors for cables
- Order numbers and specifications for wiring materials

📖 *Σ-7-Series AC Servo Drive Peripheral Device Selection Manual (Manual No.: SIEP S800001 32)*

◆ Servomotor Main Circuit Cables

Servomotor Model	Name	Length (L)	Order Number*	Appearance
SGM7G-03 and -05 300 W, 450 W	For Servomotors without Holding Brakes	3 m	JZSP-CVM21-03-E	
		5 m	JZSP-CVM21-05-E	
		10 m	JZSP-CVM21-10-E	
		15 m	JZSP-CVM21-15-E	
		20 m	JZSP-CVM21-20-E	
		30 m	JZSP-CVM21-30-E	
		40 m	JZSP-CVM21-40-E	
		50 m	JZSP-CVM21-50-E	
	For Servomotors with Holding Brakes	3 m	JZSP-CVM41-03-E	
		5 m	JZSP-CVM41-05-E	
		10 m	JZSP-CVM41-10-E	
		15 m	JZSP-CVM41-15-E	
		20 m	JZSP-CVM41-20-E	
		50 m	JZSP-CVM41-50-E	

* Use Flexible Cables for moving parts of machines, such as robots. The recommended bending radius (R) is 90 mm or larger.

Servomotor Model	Name	Connector Specifications	Length (L)	Order Number		Appearance
				Standard Cable	Flexible Cable*1	
SGM7G-09 and -13 850 W, 1.3 kW	For Servomotors without Holding Brakes	Straight	3 m	JZSP-UVA101-03-E	JZSP-UVA121-03-E	
			5 m	JZSP-UVA101-05-E	JZSP-UVA121-05-E	
			10 m	JZSP-UVA101-10-E	JZSP-UVA121-10-E	
			20 m	JZSP-UVA101-20-E	JZSP-UVA121-20-E	
		Right-angle	3 m	JZSP-UVA102-03-E	JZSP-UVA122-03-E	
			5 m	JZSP-UVA102-05-E	JZSP-UVA122-05-E	
			10 m	JZSP-UVA102-10-E	JZSP-UVA122-10-E	
			20 m	JZSP-UVA102-20-E	JZSP-UVA122-20-E	
	(Set of Two Cables*2)	Straight	3 m	JZSP-UVA131-03-E	JZSP-UVA141-03-E	
			5 m	JZSP-UVA131-05-E	JZSP-UVA141-05-E	
			20 m	JZSP-UVA131-20-E	JZSP-UVA141-20-E	
		Right-angle	3 m	JZSP-UVA132-03-E	JZSP-UVA142-03-E	
			5 m	JZSP-UVA132-05-E	JZSP-UVA142-05-E	
			20 m	JZSP-UVA132-20-E	JZSP-UVA142-20-E	

*1. Use Flexible Cables for moving parts of machines, such as robots. The recommended bending radius (R) is 90 mm or larger.

*2. This order number is for a set of two cables (Main Power Supply Cable and Holding Brake Cable). When you purchase them separately, the order numbers for Main Power Supply Cables are the same as for a Servomotor without a Holding Brake. The following order numbers are for a Holding Brake Cable. These Standard Cables are Flexible Cables.

- Cable with Straight Plug: JZSP-U7B23-□□-E
- Cable with Right-angle Plug: JZSP-U7B24-□□-E

Rotary Servomotors
SGM7G

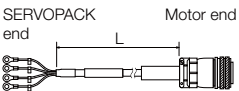
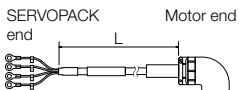
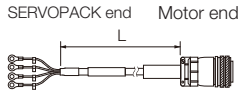
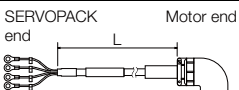
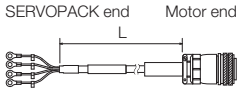
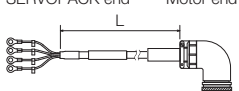
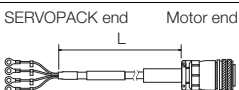
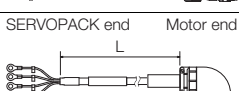
Servo-motor Model	Name	Connector Specifications	Length (L)	Order Number		Appearance
				Standard Cable	Flexible Cable* ¹	
SGM7G-20 1.8 kW	For Servomotors without Holding Brakes	Straight	3 m	JZSP-UVA301-03-E	JZSP-UVA321-03-E	
			5 m	JZSP-UVA301-05-E	JZSP-UVA321-05-E	
			10 m	JZSP-UVA301-10-E	JZSP-UVA321-10-E	
			15 m	JZSP-UVA301-15-E	JZSP-UVA321-15-E	
		Right-angle	3 m	JZSP-UVA302-03-E	JZSP-UVA322-03-E	
			5 m	JZSP-UVA302-05-E	JZSP-UVA322-05-E	
			10 m	JZSP-UVA302-10-E	JZSP-UVA322-10-E	
			15 m	JZSP-UVA302-15-E	JZSP-UVA322-15-E	
	For Servomotors with Holding Brakes (Set of Two Cables* ²)	Straight	3 m	JZSP-UVA331-03-E	JZSP-UVA341-03-E	
			5 m	JZSP-UVA331-05-E	JZSP-UVA341-05-E	
			10 m	JZSP-UVA331-10-E	JZSP-UVA341-10-E	
			15 m	JZSP-UVA331-15-E	JZSP-UVA341-15-E	
		Right-angle	3 m	JZSP-UVA332-03-E	JZSP-UVA342-03-E	
			5 m	JZSP-UVA332-05-E	JZSP-UVA342-05-E	
			10 m	JZSP-UVA332-10-E	JZSP-UVA342-10-E	
			15 m	JZSP-UVA332-15-E	JZSP-UVA342-15-E	
SGM7G-30 2.4 kW (When using an SGD7S-200A SERVO-PACK.)	For Servomotors without Holding Brakes	Straight	3 m	JZSP-UVA601-03-E	JZSP-UVA621-03-E	
			5 m	JZSP-UVA601-05-E	JZSP-UVA621-05-E	
			10 m	JZSP-UVA601-10-E	JZSP-UVA621-10-E	
			15 m	JZSP-UVA601-15-E	JZSP-UVA621-15-E	
		Right-angle	3 m	JZSP-UVA602-03-E	JZSP-UVA622-03-E	
			5 m	JZSP-UVA602-05-E	JZSP-UVA622-05-E	
			10 m	JZSP-UVA602-10-E	JZSP-UVA622-10-E	
			15 m	JZSP-UVA602-15-E	JZSP-UVA622-15-E	
	For Servomotors with Holding Brakes (Set of Two Cables* ²)	Straight	3 m	JZSP-UVA631-03-E	JZSP-UVA641-03-E	
			5 m	JZSP-UVA631-05-E	JZSP-UVA641-05-E	
			10 m	JZSP-UVA631-10-E	JZSP-UVA641-10-E	
			15 m	JZSP-UVA631-15-E	JZSP-UVA641-15-E	
		Right-angle	3 m	JZSP-UVA632-03-E	JZSP-UVA642-03-E	
			5 m	JZSP-UVA632-05-E	JZSP-UVA642-05-E	
			10 m	JZSP-UVA632-10-E	JZSP-UVA642-10-E	
			15 m	JZSP-UVA632-15-E	JZSP-UVA642-15-E	

*1. Use Flexible Cables for moving parts of machines, such as robots. The recommended bending radius (R) is 90 mm or larger.



*2. This order number is for a set of two cables (Main Power Supply Cable and Holding Brake Cable).

When you purchase them separately, the order numbers for Main Power Supply Cables are the same as for a Servomotor without a Holding Brake.

The following order numbers are for a Holding Brake Cable. These Standard Cables are Flexible Cables.

- Cable with Straight Plug: JZSP-U7B23-□□-E
- Cable with Right-angle Plug: JZSP-U7B24-□□-E

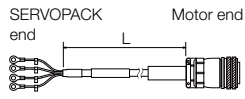
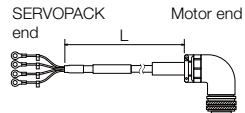
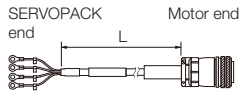
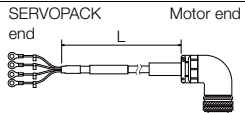
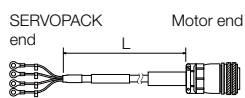
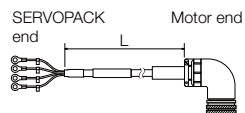
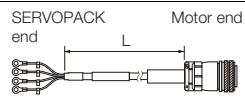
Note: If you need a Cable with a length of 20 m to 50 m, consider the operating conditions and specify a suitable length.

Servo-motor Model	Name	Connector Specifications	Length (L)	Order Number		Appearance
				Standard Cable	Flexible Cable*1	
SGM7G-30 and -44	For Servomotors without Holding Brakes	Straight	3 m	JZSP-UVA701-03-E	JZSP-UVA721-03-E	
			5 m	JZSP-UVA701-05-E	JZSP-UVA721-05-E	
			10 m	JZSP-UVA701-10-E	JZSP-UVA721-10-E	
			15 m	JZSP-UVA701-15-E	JZSP-UVA721-15-E	
			20 m	JZSP-UVA701-20-E	JZSP-UVA721-20-E	
		Right-angle	3 m	JZSP-UVA702-03-E	JZSP-UVA722-03-E	
			5 m	JZSP-UVA702-05-E	JZSP-UVA722-05-E	
			10 m	JZSP-UVA702-10-E	JZSP-UVA722-10-E	
			15 m	JZSP-UVA702-15-E	JZSP-UVA722-15-E	
			20 m	JZSP-UVA702-20-E	JZSP-UVA722-20-E	
2.9 kW, 4.4 kW	For Servomotors with Holding Brakes	Straight	3 m	JZSP-UVA731-03-E	JZSP-UVA741-03-E	
			5 m	JZSP-UVA731-05-E	JZSP-UVA741-05-E	
			10 m	JZSP-UVA731-10-E	JZSP-UVA741-10-E	
			15 m	JZSP-UVA731-15-E	JZSP-UVA741-15-E	
			20 m	JZSP-UVA731-20-E	JZSP-UVA741-20-E	
	(Set of Two Cables*2)	Right-angle	3 m	JZSP-UVA732-03-E	JZSP-UVA742-03-E	
			5 m	JZSP-UVA732-05-E	JZSP-UVA742-05-E	
			10 m	JZSP-UVA732-10-E	JZSP-UVA742-10-E	
			15 m	JZSP-UVA732-15-E	JZSP-UVA742-15-E	
			20 m	JZSP-UVA732-20-E	JZSP-UVA742-20-E	
SGM7G-55 and -75	For Servomotors without Holding Brakes	Straight	3 m	JZSP-UVAA01-03-E	JZSP-UVAA21-03-E	
			5 m	JZSP-UVAA01-05-E	JZSP-UVAA21-05-E	
			10 m	JZSP-UVAA01-10-E	JZSP-UVAA21-10-E	
			15 m	JZSP-UVAA01-15-E	JZSP-UVAA21-15-E	
			20 m	JZSP-UVAA01-20-E	JZSP-UVAA21-20-E	
		Right-angle	3 m	JZSP-UVAA02-03-E	JZSP-UVAA22-03-E	
			5 m	JZSP-UVAA02-05-E	JZSP-UVAA22-05-E	
			10 m	JZSP-UVAA02-10-E	JZSP-UVAA22-10-E	
			15 m	JZSP-UVAA02-15-E	JZSP-UVAA22-15-E	
			20 m	JZSP-UVAA02-20-E	JZSP-UVAA22-20-E	
5.5 kW, 7.5 kW	For Servomotors with Holding Brakes	Straight	3 m	JZSP-UVAA31-03-E	JZSP-UVAA41-03-E	
			5 m	JZSP-UVAA31-05-E	JZSP-UVAA41-05-E	
			10 m	JZSP-UVAA31-10-E	JZSP-UVAA41-10-E	
			15 m	JZSP-UVAA31-15-E	JZSP-UVAA41-15-E	
			20 m	JZSP-UVAA31-20-E	JZSP-UVAA41-20-E	
	(Set of Two Cables*2)	Right-angle	3 m	JZSP-UVAA32-03-E	JZSP-UVAA42-03-E	
			5 m	JZSP-UVAA32-05-E	JZSP-UVAA42-05-E	
			10 m	JZSP-UVAA32-10-E	JZSP-UVAA42-10-E	
			15 m	JZSP-UVAA32-15-E	JZSP-UVAA42-15-E	
			20 m	JZSP-UVAA32-20-E	JZSP-UVAA42-20-E	

*1. Use Flexible Cables for moving parts of machines, such as robots. The recommended bending radius (R) is 90 mm or larger.

*2. This order number is for a set of two cables (Main Power Supply Cable and Holding Brake Cable). When you purchase them separately, the order numbers for Main Power Supply Cables are the same as for a Servomotor without a Holding Brake. The following order numbers are for a Holding Brake Cable. These Standard Cables are Flexible Cables.

- Cable with Straight Plug: JZSP-U7B23-□□-E
- Cable with Right-angle Plug: JZSP-U7B24-□□-E

Note: If you need a Cable with a length of 20 m to 50 m, consider the operating conditions and specify a suitable length.

Rotary Servomotors
SGM7G

Servo-motor Model	Name	Connector Specifications	Length (L)	Order Number		Appearance
				Standard Cable	Flexible Cable * ¹	
SGM7G-1A and -1E 11 kW, 15 kW	For Servomotors without Holding Brakes	Straight	3 m	JZSP-UVAB01-03-E	JZSP-UVAB21-03-E	
			5 m	JZSP-UVAB01-05-E	JZSP-UVAB21-05-E	
			10 m	JZSP-UVAB01-10-E	JZSP-UVAB21-10-E	
			15 m	JZSP-UVAB01-15-E	JZSP-UVAB21-15-E	
			20 m	JZSP-UVAB01-20-E	JZSP-UVAB21-20-E	
		Right-angle	3 m	JZSP-UVAB02-03-E	JZSP-UVAB22-03-E	
			5 m	JZSP-UVAB02-05-E	JZSP-UVAB22-05-E	
			10 m	JZSP-UVAB02-10-E	JZSP-UVAB22-10-E	
			15 m	JZSP-UVAB02-15-E	JZSP-UVAB22-15-E	
			20 m	JZSP-UVAB02-20-E	JZSP-UVAB22-20-E	
	For Servomotors with Holding Brakes (Set of Two Cables* ²)	Straight	3 m	JZSP-UVAB31-03-E	JZSP-UVAB41-03-E	
			5 m	JZSP-UVAB31-05-E	JZSP-UVAB41-05-E	
			10 m	JZSP-UVAB31-10-E	JZSP-UVAB41-10-E	
			15 m	JZSP-UVAB31-15-E	JZSP-UVAB41-15-E	
			20 m	JZSP-UVAB31-20-E	JZSP-UVAB41-20-E	
Right-angle		3 m	JZSP-UVAB32-03-E	JZSP-UVAB42-03-E		
		5 m	JZSP-UVAB32-05-E	JZSP-UVAB42-05-E		
		10 m	JZSP-UVAB32-10-E	JZSP-UVAB42-10-E		
		15 m	JZSP-UVAB32-15-E	JZSP-UVAB42-15-E		
		20 m	JZSP-UVAB32-20-E	JZSP-UVAB42-20-E		

*1. Use Flexible Cables for moving parts of machines, such as robots. The recommended bending radius (R) is 90 mm or larger.

*2. This order number is for a set of two cables (Main Power Supply Cable and Holding Brake Cable). When you purchase them separately, the order numbers for Main Power Supply Cables are the same as for a Servomotor without a Holding Brake.

The following order numbers are for a Holding Brake Cable. These Standard Cables are Flexible Cables.

- Cable with Straight Plug: JZSP-U7B23-□□-E
- Cable with Right-angle Plug: JZSP-U7B24-□□-E

Note: If you need a Cable with a length of 20 m to 50 m, consider the operating conditions and specify a suitable length.

◆ Encoder Cables of 20 m or Less

Servomotor Model	Name	Length (L)	Order Number		Appearance	
			Standard Cable	Flexible Cable* ¹		
All SGM7G models	For incremental encoder, or batteryless absolute encoder	3 m	JZSP-CVP01-03-E	JZSP-CVP11-03-E		
		5 m	JZSP-CVP01-05-E	JZSP-CVP11-05-E		
		10 m	JZSP-CVP01-10-E	JZSP-CVP11-10-E		
		15 m	JZSP-CVP01-15-E	JZSP-CVP11-15-E		
		20 m	JZSP-CVP01-20-E	JZSP-CVP11-20-E		
		3 m	JZSP-CVP02-03-E	JZSP-CVP12-03-E		
		5 m	JZSP-CVP02-05-E	JZSP-CVP12-05-E		
		10 m	JZSP-CVP02-10-E	JZSP-CVP12-10-E		
	15 m	JZSP-CVP02-15-E	JZSP-CVP12-15-E			
	For absolute encoder: With Battery Case* ²	3 m	JZSP-CVP06-03-E	JZSP-CVP26-03-E		
		5 m	JZSP-CVP06-05-E	JZSP-CVP26-05-E		
		10 m	JZSP-CVP06-10-E	JZSP-CVP26-10-E		
		15 m	JZSP-CVP06-15-E	JZSP-CVP26-15-E		
		3 m	JZSP-CVP07-03-E	JZSP-CVP27-03-E		
		5 m	JZSP-CVP07-05-E	JZSP-CVP27-05-E		
		10 m	JZSP-CVP07-10-E	JZSP-CVP27-10-E		
15 m		JZSP-CVP07-15-E	JZSP-CVP27-15-E			
		20 m	JZSP-CVP07-20-E	JZSP-CVP27-20-E		

*1. Use Flexible Cables for moving parts of machines such as robots. The recommended bending radius (R) is 90 mm or larger.

*2. If a battery is connected to the host controller, the Battery Case is not required. If so, use a cable for incremental encoders.

Line id: @zzzz

◆ Relay Encoder Cables of 30 m to 50 m

Servomotor Model	Name	Length (L)	Order Number for Standard Cable	Appearance
All SGM7G models	Encoder-end Cable (for all types of encoders)	0.3 m	JZSP-CVP01-E	
			JZSP-CVP02-E	
	Cables with Connectors on Both Ends (for all types of encoders)	30 m	JZSP-UCMP00-30-E	
		40 m	JZSP-UCMP00-40-E	
		50 m	JZSP-UCMP00-50-E	
	Cable with a Battery Case (Required when an absolute encoder is used.)*	0.3 m	JZSP-CSP12-E	

* This Cable is not required if you use a Servomotor with a Batteryless Absolute Encoder, and you connect a battery to the host controller.

MEMO

上正科技有限公司
購買、維修 此手冊零組件
電話： 037-466333
Email: service@repairtw.com
Line id: @zzzz
www.repairtw.com

Σ-7 SERIES

IRUMA BUSINESS CENTER (SOLUTION CENTER)

480, Kamifujisawa, Iruma, Saitama, 358-8555, Japan
Phone 81-4-2962-5151 Fax 81-4-2962-6138
<http://www.yaskawa.co.jp>

YASKAWA AMERICA, INC.

2121, Norman Drive South, Waukegan, IL 60085, U.S.A.
Phone 1-800-YASKAWA (927-5292) or 1-847-887-7000 Fax 1-847-887-7310
<http://www.yaskawa.com>

YASKAWA ELÉTRICO DO BRASIL LTDA.

777, Avenida Piraporinha, Diadema, São Paulo, 09950-000, Brasil
Phone 55-11-3585-1100 Fax 55-11-3585-1187
<http://www.yaskawa.com.br>

YASKAWA EUROPE GmbH

185, Hauptstraße, Eschborn, 65760, Germany
Phone 49-6196-569-300 Fax 49-6196-569-398
<http://www.yaskawa.eu.com>

YASKAWA ELECTRIC KOREA CORPORATION

35F, Three IFC, 10 Gukjegeumyung-ro, Yeongdeungpo-gu, Seoul, 07326, Korea
Phone 82-2-784-7844 Fax 82-2-784-8495
<http://www.yaskawa.co.kr>

YASKAWA ELECTRIC (SINGAPORE) PTE. LTD.

151, Lorong Chuan, #04-02A, New Tech Park 556741, Singapore
Phone 65-6282-3003 Fax 65-6289-3003
<http://www.yaskawa.com.sg>

YASKAWA ELECTRIC (THAILAND) CO., LTD.

59, 1st-5th Floor, Flourish Building, Soi Ratchadapisek 18, Ratchadapisek Road, Huaykwang, Bangkok 10310, Thailand
Phone: +66-2-017-0099 Fax: +66-2-017-0799
<http://www.yaskawa.co.th>

YASKAWA ELECTRIC (CHINA) CO., LTD.

22F, One Corporate Avenue, No.222, Hubin Road, Shanghai, 200021, China
Phone 86-21-5385-2200 Fax 86-21-5385-3299
<http://www.yaskawa.com.cn>

YASKAWA ELECTRIC (CHINA) CO., LTD. BEIJING OFFICE

Room 1011, Tower W3 Oriental Plaza, No.1, East Chang An Ave.,
Dong Cheng District, Beijing, 100738, China
Phone 86-10-8518-4086 Fax 86-10-8518-4082
電話: 037-466333

YASKAWA ELECTRIC TAIWAN CORPORATION

9F, 16, Nanking E. Rd., Sec. 3, Taipei, 104, Taiwan
Phone 886-2-2502-5003 Fax 886-2-2505-1280
service@repairtw.com
<http://www.yaskawa-taiwan.com.tw>

Line id: @zzzz

www.repairtw.com

YASKAWA

YASKAWA ELECTRIC CORPORATION

In the event that the end user of this product is to be the military and said product is to be employed in any weapons systems or the manufacture thereof, the export will fall under the relevant regulations as stipulated in the Foreign Exchange and Foreign Trade Regulations. Therefore, be sure to follow all procedures and submit all relevant documentation according to any and all rules, regulations and laws that may apply. Specifications are subject to change without notice for ongoing product modifications and improvements.

© 2014-2017 YASKAWA ELECTRIC CORPORATION

LITERATURE NO. KAEP S800001 23F <5>-1

Published in Japan February 2017

16-8-16