

ADVANCED AND EVER ADVANCING MITSUBISHI ELECTRIC

MITSUBISHI

General Purpose Inverter

FREQROL-U₁₀₀

Instruction Manual

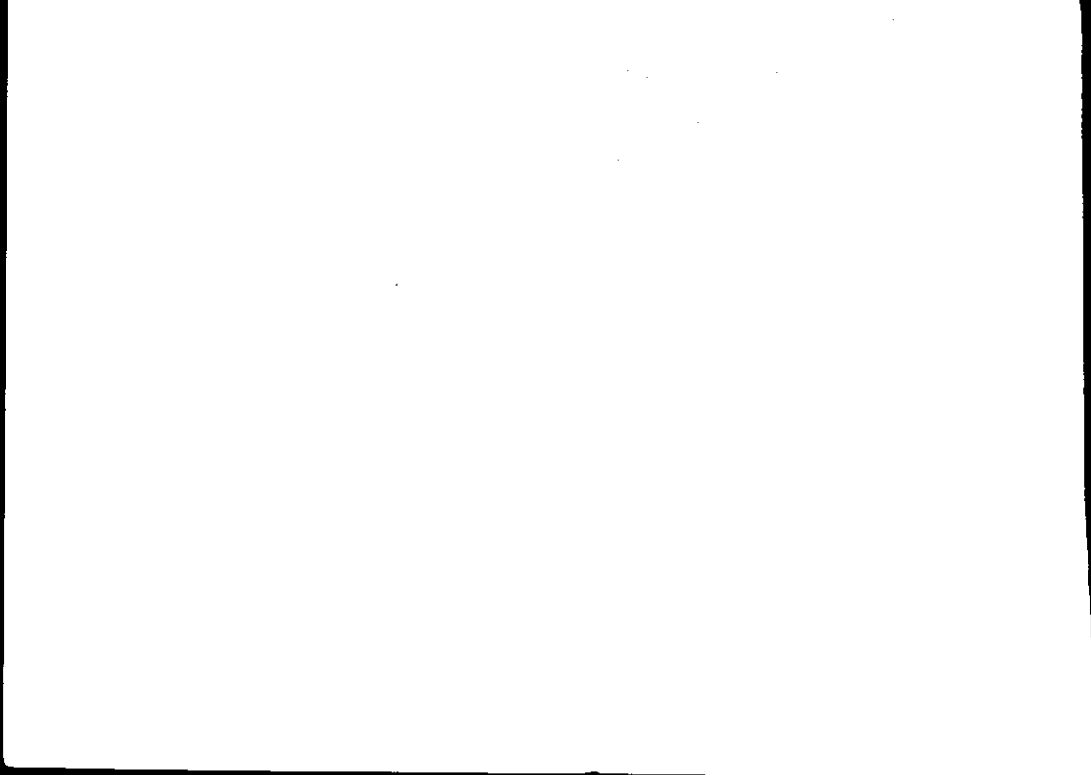

Thank you for choosing this Mitsubishi Inverter.
This manual gives handling, safety and operating instructions.

This section is specifically about safety matters

Read this manual carefully and become familiar with the inverter before operation, pay special attention to the safety information marked Warning.

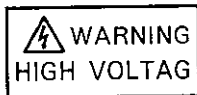

This warning symbol indicates the presence of dangerous voltage. It informs you of high voltage conditions, situations and locations that may cause death or serious injury if you do not follow precautions.

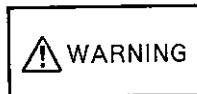





This symbol indicates a general warning. Serious injury may occur if precautions are not followed.

Where these Warnings are written, pay special attention to the precautions detailed.

Operator Safety



1. Electric shock prevention

WARNING HIGH VOLTAGE

-  Do not remove the front cover while there is power supplied to the inverter, there are high voltage terminals which can be accessed. Please check the wiring when the inverter is not powered.
-  There are high voltage capacitors in the main circuit which remain charged after the inverter has been turned off, wait 10 minutes after the Power Lamp has gone out and check for no residual voltage across terminals "P/+" and "-" ("P" and "N") before touching wires.
-  Use good earthing. Earth the inverter before wiring the Power circuits and control circuits.
-  Do not operate with wet hands.
-  Do not damage, cut, trap, or degrade the cables.





2. Fire Prevention

WARNING

-  Do not mount on or near combustible material (such as wood)
-  Use a circuit breaker on the supply side of the inverter to prevent high current flow in the case of a fault.
-  Do not connect a resistor directly to terminals "P" and "N".

3. Injury Prevention

WARNING

-  Only supply the inverter with the voltage on the nameplate and in the Manual Specification section.
-  Other voltages may cause the inverter to fail.
-  Care should be taken when wiring to ensure correct terminals are used. Check polarity etc., .
-  Do not touch the inverter while it is powered as certain parts become hot.

4. Other points

To prevent injury, damage, or product failure please note the following points.

(1) Transportation and mounting

⚠ WARNING

- ⚠ Take care when carrying products, use correct lifting gear.
- ⚠ Do not stack the inverter boxes higher than the number recommended.
- ⚠ Ensure the installation position and material can withstand the weight of the inverter. Install according to the information in the Instruction Manual.
- ⚠ Do not operate if the inverter is damaged or has parts missing.
- ⚠ Do not lift the inverter with the front cover attached, it may fall off.
- ⚠ Do not stand or rest heavy objects on the inverter.
- ⚠ Check the inverter mounting orientation is correct.
- ⚠ Prevent any dust, wire fragments or other foreign bodies from dropping into the inverter during wiring up and commissioning.

⚠ WARNING

- ⚠ Do not drop the inverter, or subject it to impacts.
- ⚠ Environmental limitations, Check the ambient temperature, humidity, storage temperature, atmosphere, altitude, vibration.
-10°C to +50°C (without freezing) -10°C to +40°C for enclosed specification.
Less than 90% Relative Humidity without condensation.
Ensure the environment is -20°C to +65°C (short time storage temperature), no corrosive or flammable gasses, altitude less than 1000m above sea level, vibration is less than 5.9m/s² {0.6 G} (based on JIS C 0911)

(2) Wiring

⚠ WARNING

- ⚠ Do not fit power factor correction capacitor, or RFI filter to the output of the inverter.
- ⚠ The connection orientation of the output cables U, V, W to the motor will effect the direction of rotation of the motor.



(3) Trial run

WARNING

-  Check all parameters, and ensure that the machine will not be damaged by sudden start-up.

(4) Operation

WARNING

-  When retry function is selected the inverter will try to restart the machine up to 10 times over a 1 hour period. Ensure operator safety with other devices.
-  The stop key can only be used at all times to stop the inverter when a parameter has been set, therefore use an external emergency stop button. Switch off start signal when resetting the inverter, failure to do so may start the motor immediately after reset.
-  The Electronic motor thermal protection does not guarantee to prevent motor burn out.

⚠ WARNING

- ⚠ Do not use a contactor in the inverter input for frequent start /stopping of the inverter, use control signals.
- ⚠ To reduce the effect of mains conducted electromagnetic interference use a RFI noise filter.
- ⚠ Take care to ensure electromagnetic radiation from the inverter does not damage or effect the operation of nearby electrical equipment.
- ⚠ Use an input line reactor when the power supply capacity is large, or where harmonics from the inverter will cause problems.
- ⚠ Take countermeasures to prevent motor insulation damage from micro surge voltages in the supply cable.
- ⚠ Reset the inverter before starting set-up, initialises the parameters to factory set values.
- ⚠ Do not use the inverter and motor at high speed until the machine has been checked.
- ⚠ The inverter does not have a holding stop facility. For emergency stop another circuit must be used.

(5) Emergency stop

 WARNING

 Use a circuit and mechanical brake etc. which will protect the operator of the machine should the inverter fail.

(6) Maintenance and inspection

 WARNING

 Do not carry out a megga (insulation resistance) test on the control circuit of the inverter.

(7) Disposing of the inverter.

 WARNING

 Treat as industrial waste.

(8) General

Many of the diagrams and drawings in the instruction manual show the inverter without a cover, or partially open, never run the inverter like this. Always replace the cover and ensure adequate cooling etc. before using the inverter.

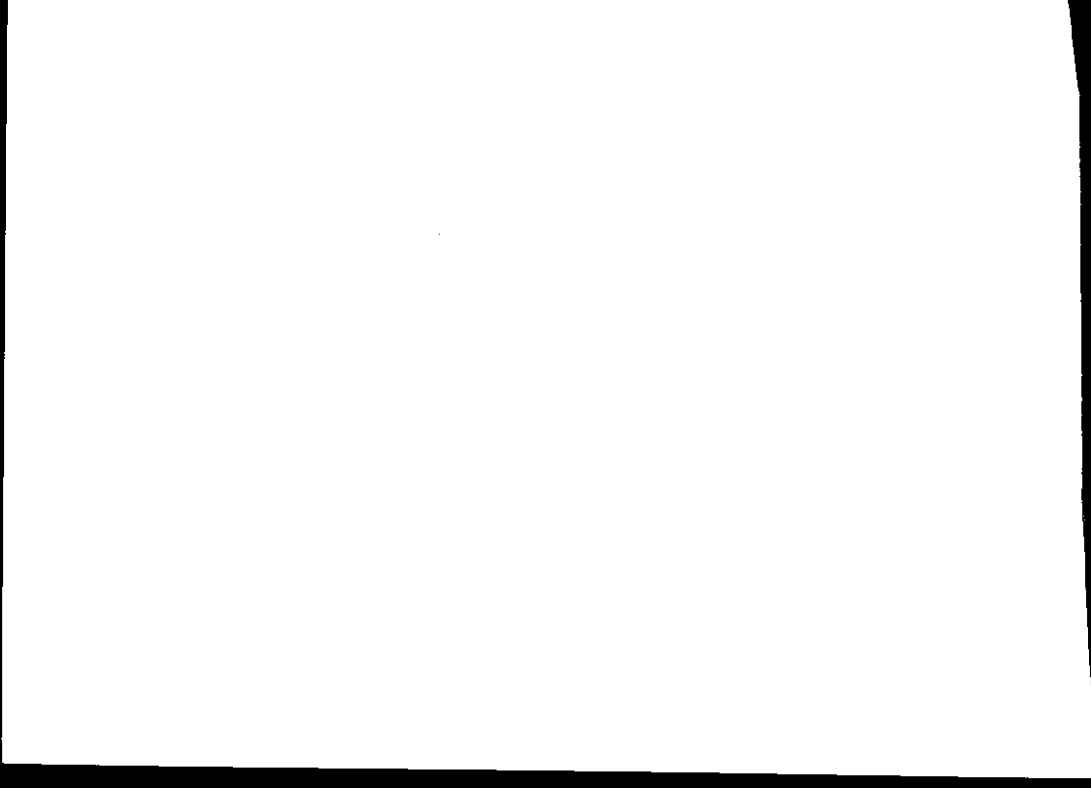

Thank you for purchasing the Mitsubishi general purpose inverter FREQROL-U100.
For safe operation, please read this manual thoroughly before using this device.

Table of Contents

1. INSPECTION AT DELIVERY	1
2. NAMES AND FUNCTIONS OF EACH PART	3
3. INSTALLATION	7
4. WIRING	9
■ Precautions for wiring	9
■ Connecting power supply and motor	10
■ Connecting control signals	11
■ Wire size and peeling length	13
5. OPERATION	17
■ Operation methods	17
■ How to use the key pad	20
■ Monitor and parameter settings	21
6. FUNCTIONS	23
■ List of functions	23
■ Explanation of functions	25

7. SPECIFICATIONS	46
■ Standard series	46
■ Low-acoustic noise series	47
■ Single phase 100V input series	48
■ Single phase 200V input series	49
■ Common specifications	50
■ Terminal wiring diagram	52
■ Explanation of terminal specifications	54
■ Protective function	56
8. DIMENSIONAL OUTLINE DRAWING	60
■ Standard series	60
■ Low-acoustic noise series	62
■ Single phase 200V power input series	64
■ Single phase 100V power input series	66
■ Fully enclosed type series	67
■ Multi function Low-acoustic noise, fully enclosed type series	69
9. SELECTION OF PERIPHERAL DEVICES	71

1. INSPECTION AT DELIVERY

Confirm the following points when unpacking the device.

- (1) Check the model plate on the front of the inverter and the rating plate on the side and check that the delivered device is the same as that ordered.
- (2) Check for damage caused during shipment.

If there any unclear points or damage is found in the device, please contact the place of purchase or your nearest Mitsubishi dealer.

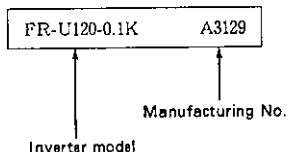

Details of model plate

MITSUBISHI INVERTER	
MODEL	FR-U120-0.1K
POWER	1/8 HP
AC INPUT	AC200-230V 50/60Hz
OUTPUT	0.8A
SERIAL	A31290007
MITSUBISHI ELECTRIC	

← Inverter model

← Applicable motor capacity

← Applicable power supply

← Rated output current

← Manufacturing No.

Details of rating plate

Details of model

FR - U 1 2 0 - 0.1 K -

Symbol	Voltage
1	100V class
2	200V class

Symbol	No. of power phases etc.
None	3-phase input
S	Single phase input
W	Single phase input (double voltage output)

Symbol	Noise, etc.
None	Standard
N	Low-acoustic noise

Symbol	Applicable motor capacity
0.1K to 1.5K	Inverter capacity is shown in kW units.

Symbol	Protective structure
None	Closed type (Japanese domestic type)
C	Totally enclosed type (special)
UL	UL listed CSA certified

- P - WITH PU
 - UP - WITH PU &
 UL LISTED

2. NAMES AND FUNCTIONS OF EACH PART

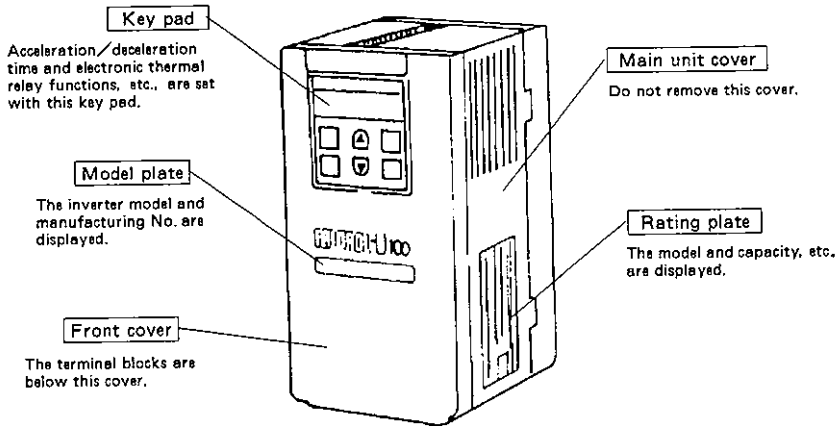

State with front cover removed
(For FR-U₁₂₀-□)

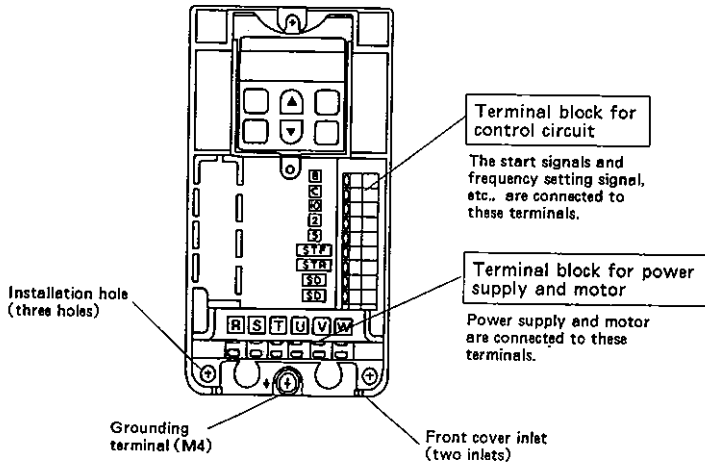

How to remove / mount front cover

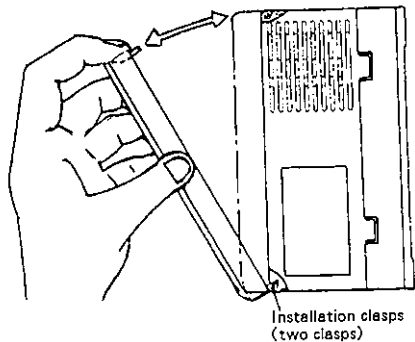

The cover can be removed by pushing the top and pulling it forward. To mount the cover, insert the two installation clasps on the bottom of the cover into the inlets on the main unit cover, and press on the cover.

Specifications for totally enclosed type

There is an exclusive wiring cover as shown below. Cut the wiring cover windows with nippers or cutters when wiring,

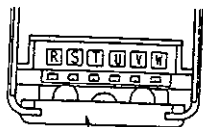

Exclusive wiring cover
(protective bushing)

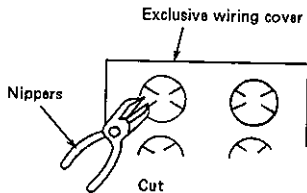

3. INSTALLATION

- Install the inverter vertically.
Non-vertical installation methods will cause the inverter's heat dissipating effect to decrease, and may cause unforeseen problems and breakdowns.



Right
Vertical
installation



Wrong
Horizontal
installation



Wrong
Sideways
installation

- Keep the ambient temperature within the permissible temperature range.
If the inverter's ambient temperature rises due to installation near a heat generating object or installation in a panel will cause the inverter life to decrease remarkably.

Take cooling methods and panel dimensions into consideration when installing the inverter in a panel.

- Tolerable ambient temperature : -10 to 50°C
(-10 to $+40^{\circ}\text{C}$ for totally enclosed type)
- Points for measuring ambient temperature

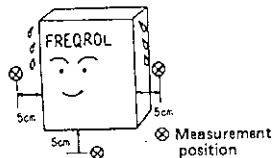

Note : The inverter was designed for use in separately earthed enclosure.
Precautions must therefore be taken at point of installation to minimise risk of hazard to users.

- Ambient space

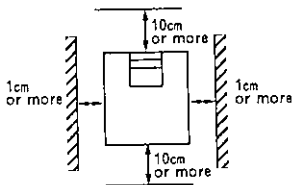

● **Avoid installation in the following places**

- Where the inverter is subject to direct sunlight
- Humid places
- Places contaminated with oil mist, dust, lint or corrosive gases. Where the inverter is subject to wind containing salt.
- Places that vibrate

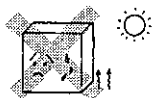

Pay attention to carriages or press machines, etc.

- Places where explosive gases exist.



- Installation on flammable material such as wood.

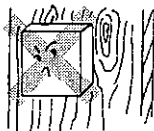

4. WIRING

■ Precautions for wiring

Pay attention to the following items during wiring to prevent mistaken wiring and mistaken usages.

Precautions for wiring

- (1) When the power supply is applied on the inverter output terminals (U, V and W), the inverter will be damaged. Never wire the power supply to these terminals.
- (2) Use a shield or twisted wire for the wiring to the control circuit terminal, and separate the wires from the main circuit or power distribution circuit (200V relay sequence circuit, etc.).
- (3) Cover the slits on the inverter so that the wire waste does not enter the inverter during wiring.
- (4) Confirm that the display lamp on the key pad has gone out before changing the wiring after operation, and wait at least two minutes before starting the wiring. (It takes more than one minutes for discharge of the internal capacitors after disconnecting power supply.)

■ Connecting power supply and motor

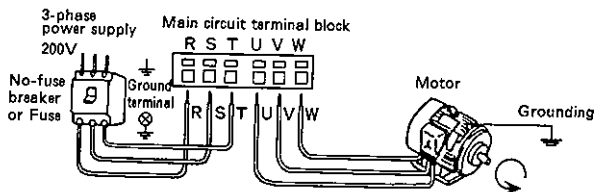

Always connect the power supply wires to R, S and T.
Never connect to U, V and W
as the inverter will be damaged.

(The phases do not need to be matched.)

Connect the motor to U, V and W.

The motor rotation direction will be counterclockwise (direction of the arrow, shown above) looking from the load shaft when the wires are connected as shown above and the forward rotation switch (signal) is turned on.

Single phase input series

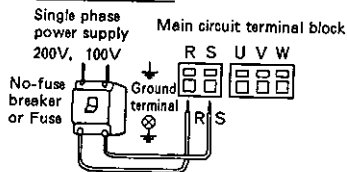

■ Connecting control signals

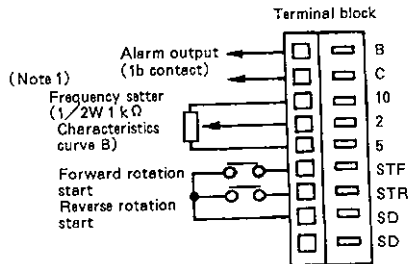

(Note 1) 2W1k Ω is recommended if the frequency setting is to be changed frequently.

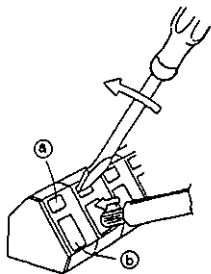

Connection of main circuit terminals

Use a small minus screwdriver (with blade width 2.5 to 3 mm).

It is introduced in the upper slot (a) and its blade holds the spring open so that the stripped power supply wire can be introduced into the terminal (b).

Withdraw the screwdriver, the conductor is clamped.

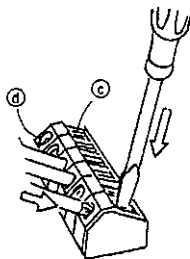

Connection of control circuit terminal

Insert a small minus screwdriver (with blade width 2.5 to 3 mm) into the right hole (c), and insert the stripped wire into (d) while pressing the screwdriver in the direction of the arrow. Remove the screwdriver when the wire has been inserted.

(Note) Use a small flat-blade screwdriver (blade width 2.5 to 3mm).

■ Wire size and peeling length

● Applicable wire size for terminal block

	Main circuit (Note 1)	Control circuit
Wire size	Solid wire : $\phi 0.3$ to $\phi 1.8$ mm Strand : 0.08 to 2.5 mm ²	Solid wire : $\phi 0.4$ to $\phi 1.0$ mm Strand : 0.3 to 0.75 mm ²
Wire sheath peeling length	5 to 6 mm	8 to 10 mm

Screwless terminal is standard feature for the terminal blocks excluding the grounding terminal.

Connected with rod terminals* or with only the wire instead of using crimp terminals.

(When using strands, make sure that the strands do not loosen to avoid a short circuit.)

Use a crimp terminal for only the grounding terminal.

(Note 1)

The wire sizes shown above are available, but a 2 mm² wire is recommended in terms of reliability.

*Example of rod terminals

Circuit	Applicable terminal name	Applicable wire size		Manufacturer
		Solid wire (mm)	Strand wire (mm)	
Main circuit terminal	TC-1.25 (S)	ϕ 0.57 to ϕ 1.44	0.25 to 1.65	Nichifu Terminal
	TC-2 (S)	ϕ 1.14 to ϕ 1.82	1.04 to 2.36	
	TUB-1.25	ϕ 0.57 to ϕ 1.44	0.55 to 1.65	Japan Solderless Terminal
Control circuit terminal	TC-0.5	ϕ 0.57 to ϕ 0.7	0.25 to 0.75	Nichifu Terminal
	H0.25/10	ϕ 0.57	0.25	Japan Weidmuller

Details to be checked in wiring planning

- (1) When the circuit has current loop in the power supply due to a mistaken connection as well as to a commercial selector circuit as shown on the right, the inverter will be damaged. Always create an electrical and mechanical interlock for MC1 and MC2.

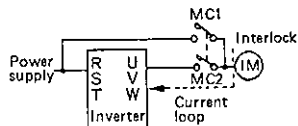

- (2) If a power failure occurs and the start signal (start switch) is retained, the inverter will automatically resume operation when the power is restored. If the machine must be prevented from restarting with power restoration, install a magnetic contactor MC on the primary side of the inverter, and design a sequence to prevent the start signal from turning ON.
- (3) Use two contacts in parallel or a twin contact to prevent an imperfect contact for the input signal of the control circuit.
- (4) Do not input a voltage on the contact input terminal (STF, etc.) of the control circuit.
- (5) Do not apply the voltage directly onto the alarm output signal terminal (B, C). Pass the voltage through a relay coil or ramp.
- (6) When directly connecting the open collector output such as that from a sequence controller into the inverter input terminal, make sure that a backflow current does not occur.

Countermeasures

- (1) Insert a diode to prevent the backflow current.
- (2) Use an all-point isolated type output unit.
(Ex. AY40A, etc.)
- (3) The external power supply voltage must be higher than the inverter's control power supply.

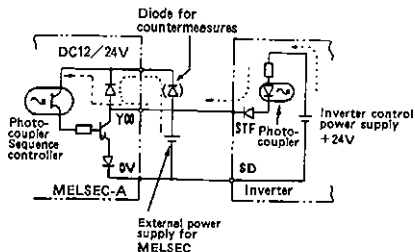

⚠ [CAUTION] REMOVAL OF COVER WHEN UNIT IS POWERED GIVES ACCESS TO HIGH VOLTAGES. PLEASE ISOLATE INVERTER FROM POWER BEFORE PERFORMING ANY ADJUSTMENTS TO WIRING, ETC. WAIT AT LEAST 3 MINUTES AFTER ISOLATION BEFORE REMOVING FRONT COVER.

5. OPERATION





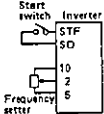
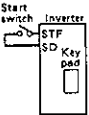
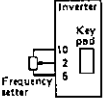

■ Operation methods

The following operation methods can be used. Select the method according to the application and operation specifications.

Operation method	Details	Remarks
Operation with key pad	Start/stop and operation frequency setting with key pad.	Factory-set to select this mode at power on. 
Operation with external input signal	Start with external switch and operation frequency is adjusted with the external frequency setter connected to the inverter control terminal.	
Combined use of Operation with external input signals and key pad. (Refer to Pr.79)	Start with external switch and setting of operation frequency with key pad.	The external frequency setter and key pad RUN and STOP keys are not accepted. 
	Start/stop with key pad. setting of operation frequency with external frequency setter.	The external start switch command is ignored. 

Operation with key pad

The key pad operation (parameter No. 79 "1") is selected as the factory setting.

-  Frequency setting mode is entered.
-   Set frequency is changed.
-  Set frequency is fixed.
-  Motor starts (forward rotation) (Note).
-  Motor stops.

(Note)

To drive the motor in the reverse direction with the **RUN** key, short-circuit between STR and SD on the terminal block, or set parameter No.78 to "2".

Operation with external input signal

- Set external operation mode (parameter No.79 "2"). (Refer to the following explanation for the setting method.)

The start signals and frequency are input with external switches and frequency setting potentiometer. The motor will operate when a signal is input into STF (forward rotation) or STR (reverse rotation) and the frequency setter is operated.

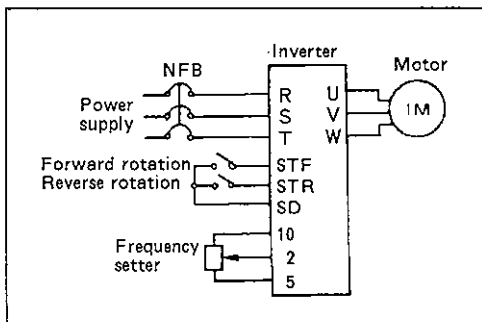

■ How to use the key pad

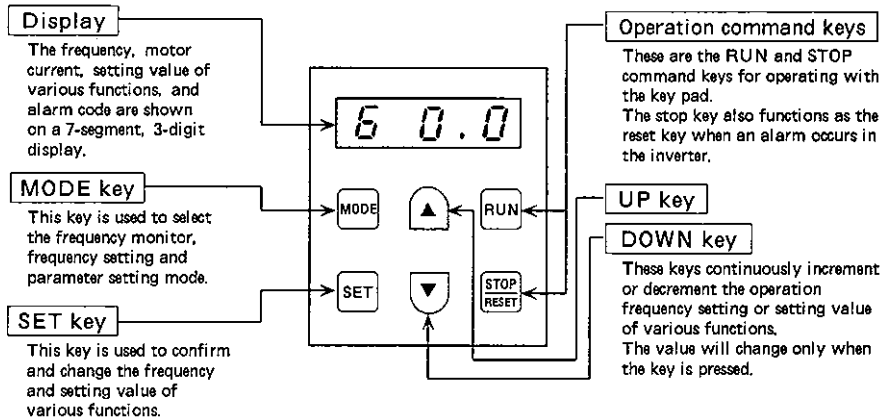

⚠ [CAUTION] DO NOT USE ANY SHARP OBJECTS ON THE KEY PAD, OR IT MAY DAMAGE THE MEMBRANE.

■ Monitor and parameter settings

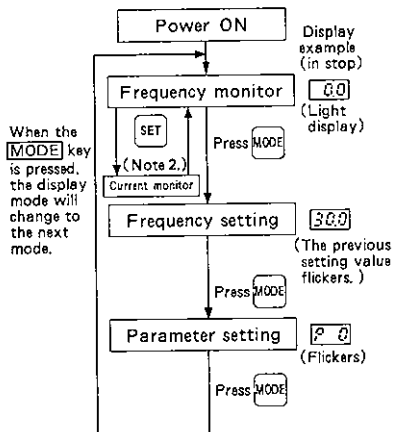

Monitoring method

- 50.0** The output frequency is displayed.
 ↑ ↓ Hold down **SET**.
1.7 The output current will display only while the SET key is pressed.
 (The display shows 1.7A)

Frequency setting method

(To change set frequency from 30Hz to 60Hz)

- 30.0** Display the set frequency. (When set to 30Hz)
 ↓ : Change the setting with the UP or DOWN key.
60.0 Adjust the frequency. (To set to 60Hz)
 ↓ **SET** (The display will flicker until the setting is completed.)
 () Complete the frequency setting.
 Flickers alternately.

Parameter setting method

(To change operation mode to external operation)

- Display the parameter setting mode with the MODE key.
P 0 Parameter number (Note 1.)
 ↓ : Change with the UP or DOWN key.
P 79 Set the parameter number.
 (To set to operation mode)

(Note)

- 1) Pressing UP or DOWN key will increment or decrement displayed parameter number by one in order of the parameter list. (PO will display if the UP key is pressed when CLr is displayed.)
- 2) The current monitor displays only when the SET key is pressed in the frequency monitor mode.

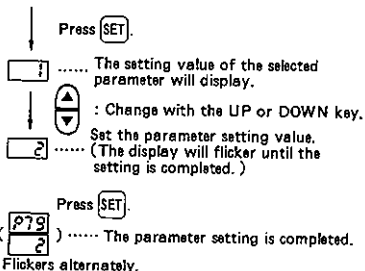

- When alarm (Er 1 to 3) is displayed
(The alarm can be canceled by pressing the mode key, not canceled by RESET key.)

Alarm display	Type	Details
Er 1	Write prohibit alarm	Writing was attempted during the pr.77 "1" state (write prohibit)
Er 2	Write alarm during operation	Pr.79 was rewritten or all clear was executed during operation.
Er 3	Calibration error	The calibration value for C-2 and C-3 was too close, *

- The calibration error will occur if the difference of the input voltage for the C-2 to C-3 calibration value is approximately 0.5V or less.

6. Functions

■ List of functions

Function No. (parameter)	Function name	Setting range	Setting unit	Factory setting	User setting
0	Torque boost (manual)	0 to 15%	1 %	6 %	
1	Upper limit frequency	0 to 120 Hz	1 Hz	120 Hz	
2	Lower limit frequency	0 to 60 Hz	1 Hz	0 Hz	
3	Base frequency	50 to 120 Hz	1 Hz	60 Hz	
7	Acceleration time	0, 0.1 to 999 sec.	0.1 sec.	5.0 sec	
8	Deceleration time	0, 0.1 to 999 sec.	0.1 sec.	5.0 sec	
9	Electronic thermal relay	0 to 15A	0.1 A	Rated current	
10	PWM mode (Note 4)	0 to 15, ---	1	3	
11	DC dynamic braking operation time	0 to 10 sec.	0.1 sec.	0.5 sec.	
12	DC dynamic braking voltage	0 to 15%	1 %	8 %	
20	Acceleration/deceleration reference frequency	1 to 120 Hz	1 Hz	60 Hz	
21	Frequency setting voltage bias	0 to 60 Hz	1 Hz	0 Hz	
22	Frequency setting voltage gain	0 to 120 Hz	1 Hz	60 Hz	
23	Stall prevention operation level	0 to 10	1	5	

Function No. (parameter)	Function name	Setting range	Setting unit	Factory setting	User setting
★ 71	Frequency meter scale calibration	0, 1	1	0	
★ 72	PWM carrier frequency	2.3 to 14.5 kHz	0.1 kHz	7.0 kHz	
75	Stop key function	0, 14	1	14	
77	Write prohibit selection	0, 1	1	0	
78	Reverse rotation prevention selection	0, 1, 2	1	0	
79	Operation mode selection	1, 2, 3, 4	1	1	
CLr	Parameter clear	0, 1, 2	1	0	
C-2	Frequency setting bias calibration	0 to 60 Hz	1 Hz	0 Hz	
C-3	Frequency setting gain calibration	0 to 120 Hz	1 Hz	60 Hz	

(Note)

1. The factory setting for Pr.79 operation mode selection is "1" (key pad mode).
2. All parameters, excluding Pr.79, and Pr.CLr parameter clear, can be written during operation.
(When Pr.77 = 0)

Writing is invalid when Pr.77=1, except for Pr.77.

3. The parameters marked with ★ are displayed only for the low-acoustic noise model.
4. The Pr.10 setting "----" can be set only for the low-acoustic noise model.

Pr.72 can be read and written when "----" is set in Pr.10.

The factory setting for the low-acoustic noise model is ----.

■ Explanation of functions

● Torque boost (manual) **0**

The low frequency band motor torque can be adjusted to the load.

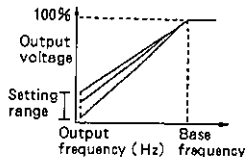

(Note)

If the setting value is too large, the overcurrent protective function may activate. The setting value can be adjusted while confirming the motor current with the monitor function.

[Factory setting]

Torque boost (manual) 6 %

● Upper limit frequency **1**

The upper and lower limit clamps of the output frequency can be set.

[Factory setting]

- Upper limit frequency 120Hz
- Lower limit frequency 0 Hz

● Lower limit frequency **2**

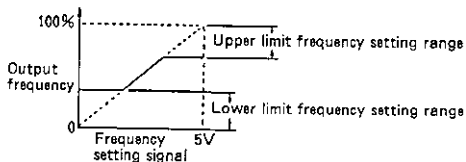

● V/F (base frequency) 3

The base frequency (reference frequency at motor rated power) can be set freely between 50 and 120Hz according to the motor rating.

[Factory setting]

V/F (base frequency)..... 60Hz

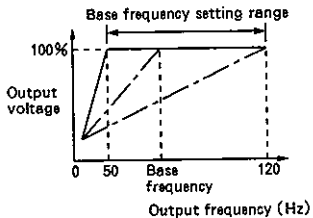

- Acceleration time 7
- Deceleration time 8
- Acceleration/deceleration reference frequency 20

Pr.7 and 8 can be set between 0.1 and 999 seconds.

Acceleration time is the time (inclination) taken for acceleration to the frequency (fm) set in acc./dec. reference frequency Pr.20.

If the acceleration/deceleration time is set to 0, the time will be 0.04 seconds.

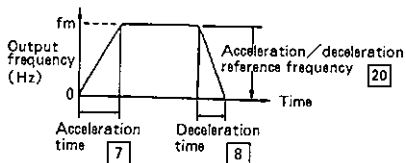

[Factory setting]

Acceleration time	5.0 sec.
Deceleration time	5.0 sec.
Acceleration/deceleration reference frequency	60Hz

● **Electronic thermal relay** **9**

The setting value can be set as a current value (A) for the motor's overheating protection. Optimum protection characteristics, including a drop in the motor cooling performance at low speed operation, can be obtained. The motor protection function will not operate when set to 0 (A). (The output transistor protection function will operate.)

Set the motor rating current at 50Hz for a triple-rating motor.
Set to 0 (A) when using the external thermal relay.

[Factory setting] (Inverter rated output current)

● **PWM mode** **10**

By changing PWM mode setting, it is possible to select motor sound appropriate for load and to reduce resonant vibration for the standard acoustic noise model. Available in sixteen settings.

Setting value	Carrier frequency	Setting value	Carrier frequency	Setting value	Carrier frequency
0	0.7 kHz	6	1.3 kHz	12	1.9 kHz
1	0.8 kHz	7	1.4 kHz	13	2.0 kHz
2	0.9 kHz	8	1.5 kHz	14	2.1 kHz
3	1.0 kHz	9	1.6 kHz	15	2.2 kHz
4	1.1 kHz	10	1.7 kHz	(Note) 2. ---	For the low-acoustic noise model
5	1.2 kHz	11	1.8 kHz		

[Factory setting] 3 (Low acoustic noise type "----")

(Note)

1. The motor tone will increase in pitch when the setting value is increased.
2. If the carrier frequency is changed for the low-acoustic noise type, set "----".
If "----" is set, the carrier frequency Pr.72 can be read and changed.
3. The setting cannot be changed from "----" to "0 to 15" during operation. Always stop before making changes. Note that the setting can be changed from "0 to 15" to "0 to 15".

● DC dynamic braking operation time **[11]**

● DC dynamic braking voltage **[12]**

By setting the DC dynamic braking torque (voltage) and the operation time, accuracy in stop position can be adjusted matching the load.

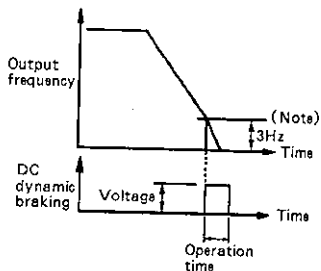

(Note)

The DC dynamic braking operation frequency is fixed to 3Hz.

Set the operation time to "0" when the DC dynamic braking is not required.

[Factory setting]

DC dynamic braking operation time ... 0.5 sec.

DC dynamic braking voltage 8 %

● Frequency setting voltage bias **21**

● Frequency setting voltage gain **22**

The output frequency (ratio) for the frequency setting signal (DC 0 to 5V) can be set freely.

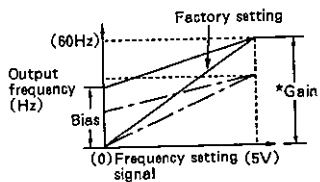

★When setting the bias and gain, the frequency setting signal need not be input.

● Stall prevention operation level **23**

An overload (excessive torque) can be prevented when driving a motor with a capacity smaller than the inverter by changing the stall prevention operation current level. This will also function during acceleration/deceleration. The operation current level is set with setting values (codes).

Setting value	Operation level	Setting value	Operation level	Setting value	Operation level
1	110%	5	150%	9	190%
2	120%	6	160%	10	200%
3	130%	7	170%	0	Stall prevention is not activated.
4	140%	8	180%		

[Factory setting] 5 (150%)

- The operation level % indicates the ratio to the inverter rated output current

● **Tone modulation selection** **71**

(This parameter is a function number for the low-acoustic noise series)

The tone control that changes the motor tone can be selected with the key pad.

Setting value	Tone selection
0	No tone control
1	Tone control

[Factory setting] 0

- The tone control changes the motor noise from a metallic tone to a composite sound that is easy to listen to.
- When the tone control is selected, the motor tone will be easy to listen to even with the same carrier frequency.
- The tone control is effective when the carrier frequency is low.

● **PWM carrier frequency** **72**

(This parameter is a function number for the low-acoustic noise series)

The PWM carrier frequency is 7.0 kHz but this frequency can be changed with Pr. 72 if necessary in relation to the load or motor resonance frequency.

(Note) If the PWM carrier frequency is lowered, the motor noise will increase, but the noise generated from the inverter and the leakage current will decrease. (Refer to the precautions on page 39 when setting the PWM carrier frequency to a higher value.)

(Note)

This parameter can be read and written when the PWM mode Pr.10 setting is "----".

[Factory setting] 7.0 kHz

● Stop key function **75**

When "stop key" is pressed in external operation mode, motor is decelerated to a stop.

Setting value	Stop key function
0	The stop key only functions in PU op or combined mode.
14	When stop key is pressed in any operation mode, motor stops.

Note 1) To restart after "stop key stopping" in ext mode.

- ① Turn off the start signal (STF/STR) after the motor has stopped.
- ② Press the "SET" key.
- ③ Turn on the start signal (STF/STR).

Note 2) When motor is stopped by using the stop key in external operation mode, "E 0" is displayed.

● Parameter write prohibit selection **[77]**

Prevents parameters from being written via the key pad.

Setting value	Write prohibition function
0	Parameter writing permitted (during operation and stop)
1	Parameter write prohibited (Note)

[Factory setting] 0

(Note)

Parameter No. **[77]** can be written in. Er1 will display when writing of other parameters is attempted. (Release the error display with the MODE key.)

● Reverse rotation prevention selection **[78]**

This is set to prevent reverse rotation fault resulting from the mis-input of the start signal.

Setting value	Rotation direction
0	Both forward/reverse rotation
1	Reverse rotation prohibited
2	Forward rotation prohibited (Note)

(Note)

The inverter will drive the motor in reverse with the RUN key when set to "2".

[Factory setting] 0

This function is valid for both the key pad operation and external operation.

● Operation mode selection **79**

The inverter operation modes include operation with external signals and operation with key pad. Operation can be limited to one mode or can be carried out with both modes.

Setting value 1	Operation only with key pad
Setting value 2	Operation only with external signals
Setting value 3	Operation frequency ... Set with key pad (direct setting or ▲▼ keys) Start signal ... External signal input (STF, STR terminals)
Setting value 4	Operation frequency ... External signal input (DC0 to 5V between terminals2-5) Start signal ... Input with key pad (RUN key) (Note) 4.

[Factory setting] 1

(Note)

1. This parameter cannot be rewritten during operation. Er2 will display if writing is attempted.
2. Setting values 3 and 4 are set to use the external signals and key pad operation for the operation frequency setting and start signals.
3. When set to 3, the operating frequency is set via key pad and analog signal input is ignored.
4. When set to 4, the operating frequency is set via analog signal input.

● Parameter clear/calibration **CLr**

The parameter-all-clear or frequency setting signal calibration mode can be selected. The parameter-clear cannot be executed during operation, and Er2 will display.

Setting value	Details
0	Not executed.
1	Parameters are all cleared (initialized). *
2	Frequency setting signal calibration mode is selected.

* Parameter No. **77**, **21**, **22** cannot be cleared.

- The following adjustment can be performed by selecting the calibration mode (setting value 2).
(Refer to page 37 for details.)

C-2 Display: Frequency setting bias calibration (Pr.21 will be rewritten simultaneously.)

C-3 Display: Frequency setting gain calibration (Pr.22 will be rewritten simultaneously.)

If the difference of the input voltages for the bias and gain calibration is less than 0.5V, the calibration error will occur (Er3 will display).

○ Example of parameter-all-clear/calibration operation

	Selection of display mode	Selection of function number	Read out of current value
Key operation	MODE → MODE	▼	SET
Display	50.0 P 0	CLr	0

Parameter-clear

Change to 1	Write in
▲	SET
?	CLr ↑ Displays alternately ?

To change Pr.C-2 from 0 Hz to 3 Hz.

Change to 2	Write in (Select calibration mode)	Read out of current value	Change to 3Hz	Write in
▲ ▲	SET	SET	▲ Changes while held down	SET
2	CL-2	0	3	CL-2 ↑ Displays alternately 3

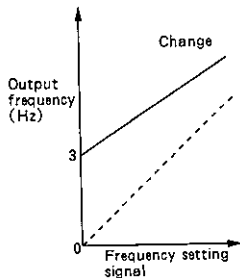

● Frequency setting bias calibration **C-2**

● Frequency setting gain calibration **C-3**

Allows the output frequency to be set in relation to the frequency setting signal (DC 0 to 5V).

<Bias>

The output frequency for the setting signal input between terminals 2-5 will be set.

<Gain>

The output frequency for the setting signal input between terminals 2-5 will be set. If the input signal is 0V, it is judged to be 5V input.

(Note)

- When this C-2 or C-3 is specified, value set for "frequency setting voltage bias" (function No. 21) or "frequency setting voltage gain" (function No.22) will be automatically rewritten.

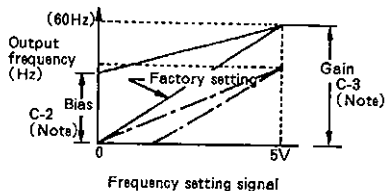

Remarks To set frequency with current input (4 to 20mA)

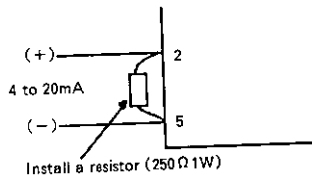

1. Place a resistor between 2-5, and convert the current into a voltage. (4 to 20mA → 1 to 5V)
2. Adjust C-2 (bias) as below.
(Pr.21 will be rewritten simultaneously.)

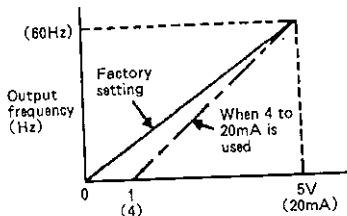

Precautions

1. It is necessary to accept a reduction of load torque when setting the PWM carrier frequency to a higher value.

- (1) When setting the PWM carrier frequency (Pr.72) to 7.1kHz or more to lower the motor acoustic noise, the rated output should be derated as shown on the right. Also change the electronic thermal relay (Pr. 9) setting.
- (2) If the PWM carrier frequency is increased, the acoustic noise from the motor will lower, but the noise generated by the inverter and the leakage current will increase.

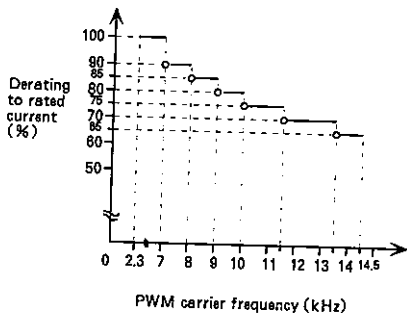

2. Noise

There is noise that enters from outside and causes the inverter to malfunction and that which is generated from the inverter and causes the peripheral equipment to malfunction. The inverter is designed so that it is not easily affected by noise, but as it is an electronic device which handles weak signals, the following general countermeasures will be required.

◆ General countermeasures

- Avoid laying the inverter's power cables (input/output) in parallel with the signal wires and avoid bundling the power cables and signal wires.
- Use twisted pair shield wires for the connection wires with the sensor and for the control signal wires. Connect the sheath of the shield wire to terminal SD.
- Use one-point grounding for the inverter and motor, etc.

◆ Example of noise countermeasures

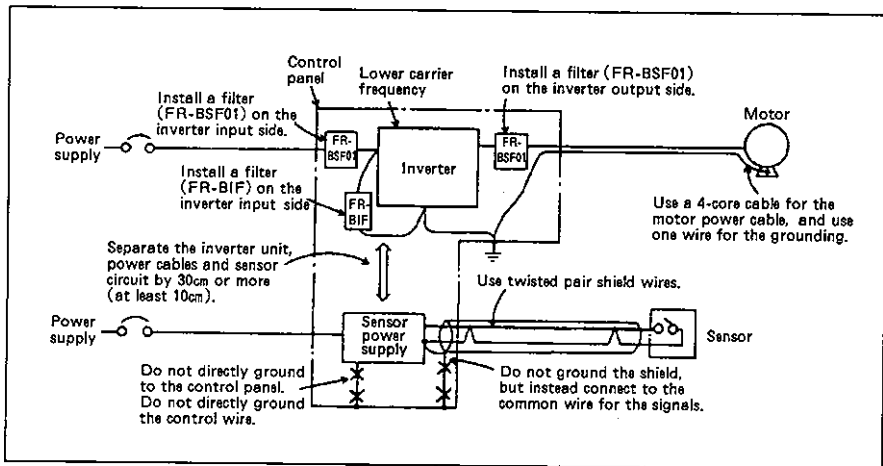

3. Leakage current

Leakage current will flow through stray capacity which exists between the ground and a cable, motor, etc. The value of the leakage current depends on the cable length, wiring method and inverter carrier frequency, and will increase when using a low-acoustic noise inverter, so use the following countermeasures.

- (1) Leakage current to the ground
The leakage current will not affect only the inverter but may pass into other equipments through the grounding cables and may cause a leakage breaker or relay unnecessary trip.

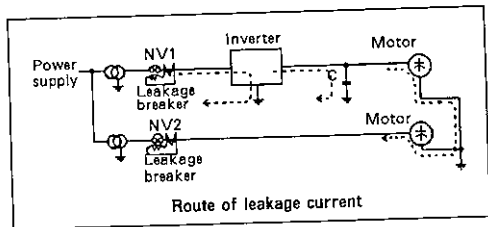

■ Countermeasures

- Lower the inverter's carrier frequency (Pr. 72). Note that this will increase the motor acoustic noise.
- Use a leakage breaker that corresponds to high harmonics and surges (Mitsubishi New Super NV Series, etc.) for the inverter or other lines when using the low-acoustic noise model (with high carrier frequency).

(2) Leakage current across the line

The harmonics of leakage current which flows through stray capacity across the inverter output lines may cause an external thermal overload protector trip. When the cable length is long (50m or more), the ratio of leakage current to the motor's rated current becomes large, and trip is liable to occur.

■ Countermeasures

- Use the electronic thermal relay on the inverter.
- Lower the carrier frequency.
Note that this will increase the motor noise.

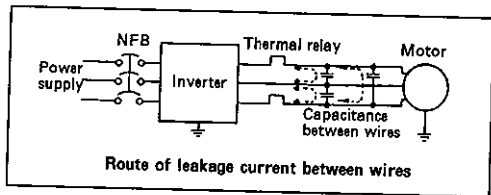

Against the trip due to leakage current, the preferred method of motor overload protection is a thermistor protection with temperature detectors in the motor or motor protection switch with bi-metal release, etc.

4. Carrier frequency

The parameter of carrier frequency (Pr.10) must be changed for the operation frequency range as following :

Operation frequency range	Pr. 10 setting value
0.5 to 77 Hz	0 to 15, ---
0.5 to 88 Hz	1 to 15, ---
0.5 to 99 Hz	2 to 15, ---
0.5 to 111 Hz	3 to 15, ---
0.5 to 120 Hz	4 to 15, ---

7. SPECIFICATIONS

■ Standard series

Model FR-U120-□-(C), -(UL)		0.1K	0.2K	0.4K	0.75K	1.5K
Applicable motor capacity (kW)/(HP) *1		0.1/1/8	0.2/1/4	0.4/1/2	0.75/1	1.5/2
Output	Rated capacity (kVA) *2	0.3	0.5	0.9	1.5	2.6
	Rated output current (A)	0.8	1.4	2.4	4.1	7
	Overload current rating *3	150% 60 sec. 200% 0.5 sec. (inverse time characteristic)				
	Rated output voltage *4	3-phase 200 to 230V (The 1.5k model of the fully enclosed type is 200 to 220V.)				
Power supply	Rated input AC voltage	3-phase 200 to 230V, 50/60Hz (The 1.5k model of the fully enclosed type is 3-phase 200V 50Hz, 3-phase 200 to 220V 60Hz.)				
	Tolerable AC voltage fluctuation	180 to 253V, 50/60Hz (The 1.5k model of the fully enclosed type is 180 to 220V 50Hz, 180 to 242V 60Hz.)				
	Tolerable frequency fluctuation	± 5%				
	Power supply capacity (kVA) *5	0.4	0.7	1.2	2.1	4.0
Enclosure		Enclosed type (IP20) Fully enclosed type is IP40.)				
Cooling method		Self-cooling (Without cooling fan) (The 1.5k model of the fully enclosed type is force-cooled.)				
Weight (kg)		0.5 *7	0.6 *7	0.7 *7	0.9 *7	1.7 *7

■ Low-acoustic noise series

Model FR-U120-N <input type="checkbox"/> - (C), -- (UL)		0.1K	0.2K	0.4K	0.75K	1.5K
Applicable motor capacity (kW)/(HP) *1		0.1/1/8	0.2/1/4	0.4/1/2	0.75/1	1.5/2
Output	Rated capacity (kVA) *2	0.3	0.5	0.9	1.5	2.6
	Rated output current (A)	0.8	1.4	2.4	4.1	7
	Overload current rating *3	150% 60 sec. 200% 0.5 sec. (inverse time characteristic)				
	Rated output voltage *4	3-phase 200 to 230V				3-phase 200 to 220V (The 1.5K model of UL type is 200 to 230V)
Power supply	Rated input AC voltage	3-phase 200 to 230V, 50/60Hz				3-phase 200V, 50Hz 200 to 220V, 60Hz (UL type is 200V, 50Hz 200 to 230V, 60Hz)
	Tolerable AC voltage fluctuation	180 to 253V, 50/60Hz				180 to 220V, 50Hz 180 to 242V, 60Hz (UL type is 180 to 220V, 50Hz 180 to 253V, 60Hz)
	Tolerable frequency fluctuation	± 5 %				
	Power supply capacity (kVA) *5	0.4	0.7	1.2	2.1	4.0
Enclosure	Enclosed type (IP20) (Fully enclosed type is IP40.)					
Cooling method	Self-cooling (Without cooling fan)				Fan cooled	
Weight (kg)	0.6 *7	0.7 *7	0.9 *7	1.7	1.9	

(Note) The power supply specifications for 1.5K differ from those for 0.75K or less, caution should be observed.

■ Single phase 100V input series

Model	Standard series FR-U110W-□-(UL)	0.1K	0.2K	0.4K
	Low-acoustic noise series FR-U110W-N□-(UL)	0.1K	0.2K	0.4K
Applicable motor capacity (kW)/(HP) *1		0.1/1/8	0.2/1/4	0.4/1/2
Output	Rated capacity (kVA) *2	0.3	0.5	0.9
	Rated output current (A)	0.8	1.4	2.4
	Overload current rating *3	150% 60 sec. 200% 0.5 sec. (inverse time characteristic)		
	Rated output voltage *4	3-phase 200 to 220V *6 (The model of UL type is 200 to 230V)		
Power supply	Rated input AC voltage	Single phase 100V 50Hz, 100 to 110V 60Hz (UL type is 100 to 115V, 50/60Hz)		
	Tolerable AC voltage fluctuation	90 to 110V 50Hz, 90 to 121V 60Hz (UL type is 90 to 126.5V, 50/60Hz)		
	Tolerable frequency fluctuation	5 %		
	Power supply capacity (kVA) *5	0.5	0.9	1.5
Enclosure		Enclosed type (IP20)		
Cooling method		Self-cooling (without cooling fan)		
Weight (kg)		0.6	0.7	0.9

■ Single phase 200V input series

Model	Standard series FR-U120S-□□-(UL)	0.1K	0.2K	0.4K	0.75K
	Low-acoustic noise series FR-U120S-N□□-(UL)	0.1K	0.2K	0.4K	0.75K
Applicable motor capacity (kW)/(HP) *1		0.1/1/8	0.2/1/4	0.4/1/2	0.75/1
Output	Rated capacity (kVA) *2	0.3	0.5	0.9	1.5
	Rated output current (A)	0.8	1.4	2.4	4.1
	Overload current rating *3	150% 60 sec. 200% 0.5 sec. (inverse time characteristic)			
	Rated output voltage *4	3-phase 200 to 220V (The model of UL type is 200 to 230V)			
Power supply	Rated input AC voltage	Single phase 200V 50Hz, 200 to 220V 60Hz (UL type is 200 to 230V, 50/60Hz)			
	Tolerable AC voltage fluctuation	180 to 220V 50Hz, 180 to 242V 60Hz (UL type is 180 to 253V, 50/60Hz)			
	Tolerable frequency fluctuation	5 %			
	Power supply capacity (kVA) *5	0.5	0.9	1.5	2.5
Enclosure		Enclosed type (IP20)			
Cooling method		Self-cooling (without cooling fan)			
Weight (kg)		0.6	0.7	0.9	1.7

(Note)

- *1. The maximum applicable capacity is for the Mitsubishi standard motor 4P. This may not apply to the 6P motor, so refer to the rated output current.
- *2. The rated capacity is shown for the output voltage of 220V (60Hz).
- *3. The overload current value % shows the ratio to the inverter's rated output current.
- *4. The output voltage cannot exceed the power supply voltage.
- *5. The necessary power capacity will differ according to the impedance on the power supply side (including reactor and power wires on input side). Prepare a power supply capacity higher than the noted value.
- *6. If a load is applied on the motor, the output voltage will drop approx. 10 to 15%, so the load must be reduced when using a general purpose motor.
- *7. The low-acoustic noise, fully enclosed type will be 0.1kg heavier.

■ Common specifications

Control specifications	Control method		Sinusoidal wave PWM control *10
	Output frequency range		0.5 to 120Hz (starting frequency fixed at 0.5Hz)
	Frequency setting resolution	Digital input	0.1Hz (less than 100Hz), 1Hz (100Hz and more) with key pad operations
		Analog input	1/500 of maximum setting frequency
	Frequency stability	Digital input	Within $\pm 0.5\%$ of set output frequency (-10 to $+50^{\circ}\text{C}$) with key pad operations
		Analog input	Within $\pm 1\%$ of maximum output frequency ($25^{\circ}\text{C} \pm 10^{\circ}\text{C}$)
	Voltage/frequency characteristics		Base frequency between 50 and 120Hz selectable
	Torque boost		Manual torque boost 0 to 15% selectable
	Acceleration/deceleration characteristics		0, 0.1 to 999 sec. selectable (acceleration/deceleration set separately)
	Braking torque	Regenerative *8	0.1K, 0.2K...150% or more, 0.4K, 0.75K...100% or more, 1.5K...50% or more
DC injection		3Hz or less Operation time, operation voltage adjustable	
Stall prevention operation level		Operation current level (110 to 200%) selectable	
Operation specifications	Frequency setting signal		DC 0 to 5V
	Input signal	Starting signal	Forward/reverse rotation commanded separately
	Output signal	Alarm	1b contact output
Display specifications	Key pad	Operation status	Output frequency, output current *11 selectable
		Alarm	Alarm code when protective function has been activated.

Protection/warning function		Overcurrent shut down (during acceleration/deceleration/constant speed), regenerative overvoltage shut off, electronic thermal overload, stall prevention
Display	Ambient temperature	-10 to +50°C (-10 to +40°C for totally enclosed type) (with no freezing)
	Ambient humidity	90% RH or less (with no dew condensation)
	Storage temperature *9	-20 to +65°C
	Atmosphere	Indoors with no corrosive or flammable gases, oil mist or dust
	Altitude/vibration	Less than 1000m above sea level, 5.9m/S ² (0.6G) or less

(Note)

- *8. The braking torque shows the short time average deceleration torque when the motor without load is decelerated in the shortest time from 60Hz (changes due to motor's loss), and is not the continuous regenerative torque. For deceleration from a frequency that exceeds the base frequency, the average deceleration torque value will decrease.
A brake resistor is not built-in and cannot be externally installed.
1.5K is not available for the single phase input series.
- *9. This is a short time temperature for during transportation, etc.
- *10. The low-acoustic noise series use the high carrier frequency sinusoidal PWM control.
- *11. The output current is displayed only while the SET key is being pressed.
- *12. Short Circuit Ratings
The drive is suitable for use on a circuit capable of delivering not more than * RMS symmetrical Amperes.

HP rating	*
0 to 1	1,000
2	5,000

Terminal wiring diagram

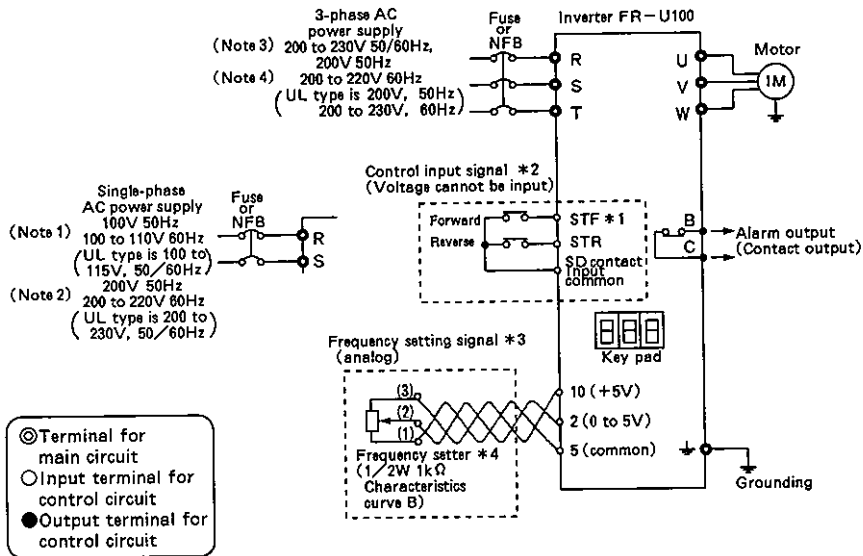

-
- * 1. Short-circuit between terminals STR-SD to perform reverse rotation with key pad operation. When Pr.78 is set to "2" (forward rotation prohibited), the motor will rotate in the reverse direction with the key pad operation even if STR-SD are not short circuited. (When Pr.79 is 1 or 4)
 - * 2. Valid when parameter No.79 is set to "2" or "3" via key pad.
 - * 3. Valid when parameter No.79 is set to "2" or "4" via key pad.
 - * 4. $2W1k\Omega$ is recommended if the frequency setting is to be changed frequently.
 - (Note 1) For single phase 100V power input series.
 - (Note 2) For single phase 200V power input series.
 - (Note 3) When using the low-acoustic, fully enclosed type series, or 0.1K to 0.75K models of the low-acoustic noise, fully enclosed type series.
 - (Note 4) When using the low-acoustic noise, fully enclosed type or 1.5K model of the low-acoustic noise, fully enclosed type series.

■ Explanation of terminal specifications

Terminal symbol	Terminal name	Details	
Main circuit	R, S, T	AC power input terminal	Connect to a commercial power supply.
	U, V, W	Inverter output terminal	Connect a 3-phase motor.
		Grounding terminal	Ground for inverter body. Ground this.
Control circuit (Input signal)	STF	Forward rotation starting terminal	Contact input terminal for the forward run command. The motor will forward rotate when STF-SD are short circuited, and will stop when released.
	STR	Reverse rotation starting terminal	Contact input terminal for the reverse run command. The motor will reverse rotate when STR-SD are short circuited, and will stop when released.
	SD	Contact input common terminal	Common terminal for the contact input signal. This is not insulated from the frequency setting input common terminal 5.
	10	Power supply terminal for frequency setting	DC5V. Tolerable load current 10mA.
	2	Frequency setting terminal (Voltage signal)	Output frequency will be the maximum when DC 5V is input, and the input/output will be in proportion. Input resistance : 10kΩ Max. tolerable input voltage : 10V

Terminal symbol	Terminal name	Details
Control circuit (Input signal)	5 Frequency setting input common terminal	Common terminal for the frequency setting signal. This is not insulated from the contact input common SD.
Control circuit (Output signal)	B, C Alarm output terminal	1b contact output that indicates that the inverter protection circuit has functioned and output has stopped. B-C opened during alarm B-C closed during normal operation Contact capacity AC230V 0.3A, DC30V 0.3A

The terminals are screwless type, so prepare a small flat-tip screwdriver (tip width 2.5 to 3mm) before wiring.

■ Protective function

The following protection functions are built in to protect the inverter. If the protective circuit functions, the inverter output will stop, alarm will display, and alarm signal will be output. The motor will coast to a stop. The inverter must be reset to resume operations.

Function name		Details	Display (Key pad)	
Overcurrent shut down		The protective circuit functions during acceleration, deceleration or constant speed when the motor output current exceeded approximately 200% of the rated current, and the inverter output stops.	During acceleration	001 (OC1)
			During constant speed	002 (OC2)
			During deceleration	003 (OC3)
Regenerative overvoltage shut down		The protective circuit functions when the DC voltage in the main circuit of the inverter exceeds the trip point with the regenerative energy during braking, and the inverter output stops.	007 (OVT)	
Overload shut down (Electronic thermal relay) (*1)	Motor	The electronic thermal relay in the inverter detects overheating of the motor caused by overload or the additional heating at low speeds due to fan action, and stops the inverter output. Install a thermal relay on the output side of the inverter when using a 6 or more pole motor or when groups of motors are connected to one drive.	580 (THM)	

Function name		Details	Display (Key pad)
Overload shut down (Electronic thermal relay) (*1)	In- verter	The electronic thermal relay functions with the inverse time characteristic to protect the output transistor when 150% or more of the inverter rated output current flows but the overcurrent shut down is not activated (under 200%).	THF (THT)
EEPROM breakage		The output will stop when the EEPROM which stores the parameter set values breaks.	PE (PE)
Stall prevention		When 150% (*2) or more of the inverter rated current flows to the motor during acceleration (or constant speed operation), this function stops increasing of frequency (or reduces frequency) until the load current decreases, to prevent the inverter from overcurrent tripping. When the load current has decreased below 150%, this function allows the inverter to return to and continue the previous operation. During deceleration, in contrast, if DC voltage in the inverter exceeds the rated value, this function stops reducing frequency to prevent the regenerative overvoltage shut off from being activated. When the regenerative energy becomes low, this function continues deceleration again.	OLF (OLT) When stopped due to this function from a constant speed operation.
Insufficient voltage warning (*3)		The control circuit will not function properly if the inverter power voltage drops, and will also cause an insufficient motor torque and increased heat generation. The inverter output will stop when the power voltage drops below approx. AC 115V. Operation will resume when the power voltage is restored to a correct value.	UV (UV)

(Note)

- * 1. The heat cumulative data in the electronic thermal relay will be initialized when the inverter is reset.
- * 2. The stall prevent operation current can be set freely. The default setting is 150%.
- * 3. An alarm signal will not be output when this protective function activates. If the voltage is insufficient (main circuit DC voltage is 230V or less) when the power is turned on, "0.0" will display for approximately 10 seconds and then the insufficient voltage display "U_L" will appear. (No key pad operation will be accepted during the display of "0.0".)
If the main circuit DC voltage is higher than standard tolerance when the power is turned on, the display "FrU" will appear, and if the voltage does not lower within 10 seconds, the display "U_of" (overvoltage shut down) will appear.

-
- **Retention of alarm output signal**
If the no-fuse breaker on the inverter's power supply side is turned OFF when the protective function activates, the inverter control power supply will be lost, and the alarm output will not be held. If the output must be held, create a sequence that will hold the alarm output signal with an external equipment.
 - **Alarm display**
The display on the key pad will automatically change when the protective function operates. (Only during monitoring.)
 - **Resetting methods**
The inverter output stop state will be retained if the protective function operates, and the inverter will not restart unless it is reset. Turn the power off and on once or press the RESET key on the key pad. If the RES terminal is set with Pr.60 (input terminal function selection), resetting will be possible by opening reset terminal RES-SD after short-circuiting for approximately 0.1 second or more. If the short circuited state between terminal RES-SD is continued, "FrU" will display (light) and indicate that the reset state has been entered

8. DIMENSIONAL OUTLINE DRAWING

■ Standard series FR-U120- - (UL)

0.1 to 0.75K Installation screw M4 (Q'ty 3 mounting holes)

(Unit : mm)

Keyhole slot dimensions

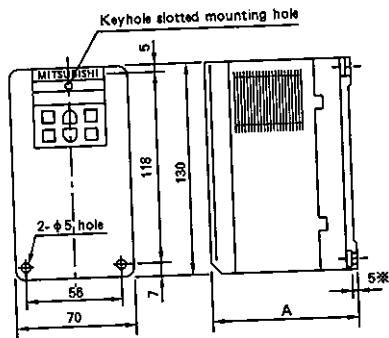

Capacity	A
0.1K	81
0.2K	86
0.4K	101
0.75K	121

*4.5 only for 0.1K.

1.5K

Installation screw M4 (4 places)

(Unit : mm)

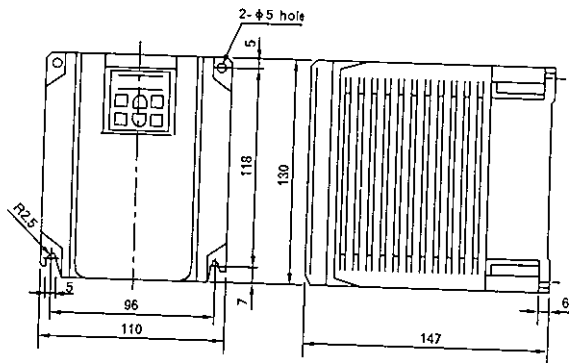

(Note)

For 1.5K drive, heatsink is provided on the left and right and it will get HOT at heavy loads. Do not hold heatsink with bare hand.

■ Low-acoustic noise series FR-U120-N - (UL)

(Unit : mm)

0.1 to 0.4K Installation screw M4 (3 places)

Keyhole slot dimensions

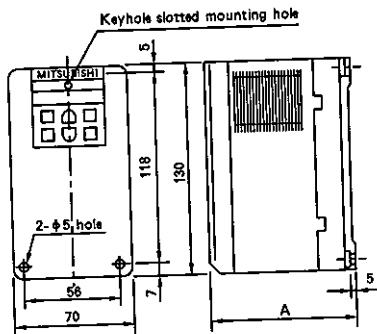

Capacity	A
0.1K	86
0.2K	101
0.4K	121

0.75, 1.5K

Installation screw M4 (4 places)

(Unit : mm)

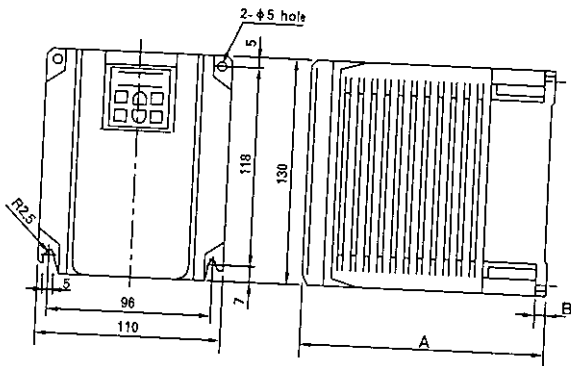

Capacity	A	B
0.75K	147	6
1.5K	155	14

(Note)

The 1.5K drive comes equipped with a fan.

(Note)

For 0.75K and 1.5K drive, heatsink is standard on the left and right and it will get HOT at heavy load. Do not hold heatsink with bare hand.

■ Single phase 200V power input series FR-U120S- - (UL)

(Unit : mm)

0.1 to 0.4K

Installation screw M4 (3 places)

Keyhole slot dimensions

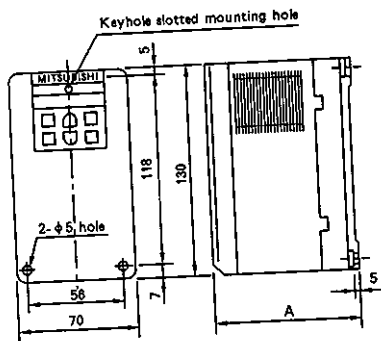

Capacity	A
0.1K	86
0.2K	101
0.4K	141

0.75K

Installation screw M4 (4 places)

(Unit : mm)

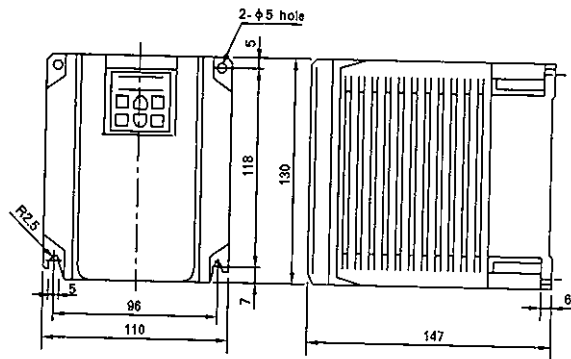

(Note)

For 0.75K drive, heatsink is standard on the left and right and it will get HOT at heavy loads.

■ Single phase 100V power input series FR-U110W- - (UL)

(Unit : mm)

0.1 to 0.4K Installation screw M4 (3 places)

Keyhole slot dimensions

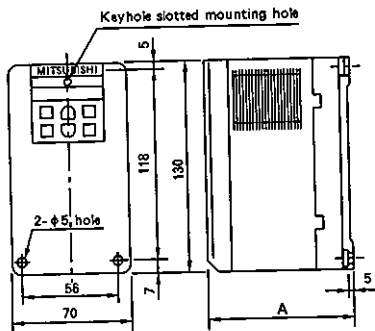

Capacity	A
0.1K	86
0.2K	121
0.4K	141

■ Fully enclosed type series FR-U120--C

0.1 to 0.75K Installation screw M4 (3 places)

(Unit : mm)

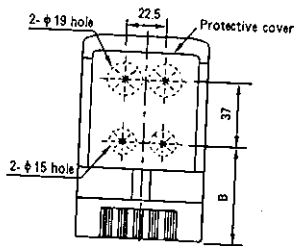
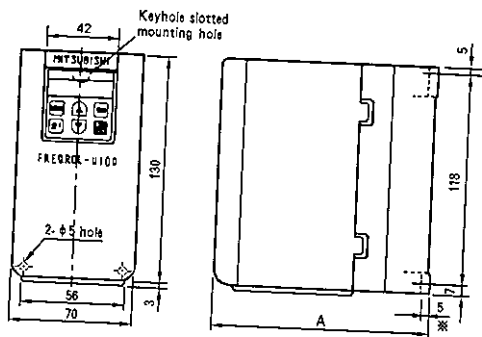

Keyhole slot dimensions



Capacity	A	B
0.1K	101	38
0.2K	106	43
0.4K	121	58
0.75K	141	78

*4.5 only for 0.1K.

(Unit : mm)

1.5K

Installation screw M4 (4 places)

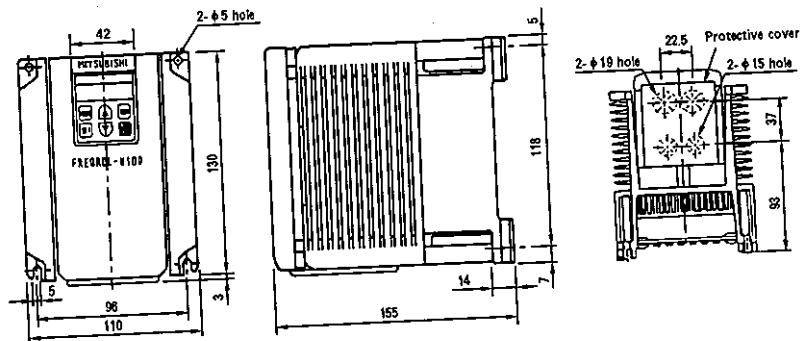

(Note) For 1.5K drive, heatsink is standard, so the temperature will rise by approx. 30 degrees depending on the usage conditions.

(Note) The 1.5K drive comes equipped with a fan.

■ Multi-function low-acoustic noise, fully enclosed type series FR-U120-N - C

0.1 to 0.4K

Installation screw M4 (3 places)

(Unit : mm)

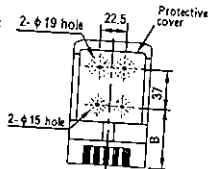
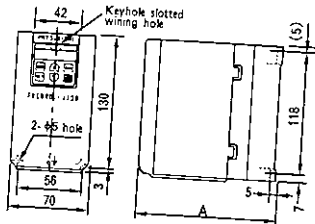

Keyhole slot dimensions



Capacity	A	B
0.1K	106	43
0.2K	121	58
0.4K	141	78

0.75K

Installation screw M4 (4 places)

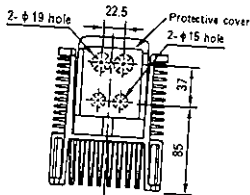
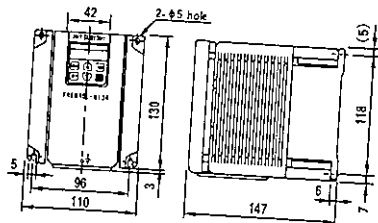

(Unit : mm)

1.5K

Installation screw M4 (4 places)

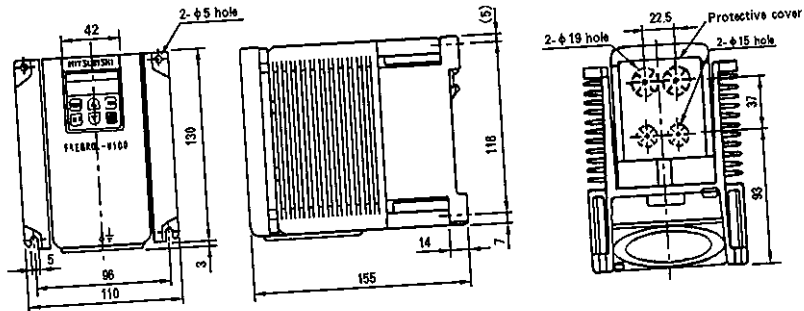

(Note) For 0.75 and 1.5K drive, heatsink is standard, so the temperature will rise by approx. 30 degrees depending on the usage conditions.

(Note) The 1.5K drive comes equipped with a fan.

9. SELECTION OF PERIPHERAL DEVICES

■ Selection of peripheral devices

(The selection will differ according to the inverter power supply input specifications.)

Power input	Motor output (kW)	Applicable inverter model	No-fuse breaker (NFB) or Leakage breaker (NV)	Magnetic contactor (MC)			Wiring (mm ²)	
				A area	B area	C area	R, S, T	U, V, W
3-phase 200V	0.1	FR-U120-N/0.1K-(c), -(UL)	NF30 model, NV30 model 5A	S-K11	S-K18	S-K20	2	2
	0.2	FR-U120-N/0.2K-(c), -(UL)	NF30 model, NV30 model 5A	S-K18	S-K20	S-K20	2	2
	0.4	FR-U120-N/0.4K-(c), -(UL)	NF30 model, NV30 model 5A	S-K18	S-K21	S-K21	2	2
	0.75	FR-U120-N/0.75K-(c), -(UL)	NF30 model, NV30 model 10A	S-K18	S-K21	S-K21	2	2
	1.5	FR-U120-N/1.5K-(c), -(UL)	NF30 model, NV30 model 15A	S-K21	S-K25	S-K50	2	2
Single phase 200V	0.1	FR-U120S-N/0.1K, -(UL)	NF30 model, NV30 model 5A	S-K18	S-K20	S-K20	2	2
	0.2	FR-U120S-N/0.2K, -(UL)	NF30 model, NV30 model 10A	S-K18	S-K21	S-K21	2	2
	0.4	FR-U120S-N/0.4K, -(UL)	NF30 model, NV30 model 10A	S-K21	S-K25	S-K50	2	2
	0.75	FR-U120S-N/0.75K, -(UL)	NF30 model, NV30 model 15A	S-K21	S-K25	S-K50	2	2
Single phase 100V	0.1	FR-U110W-N/0.1K, -(UL)	BH-K model, NV30 model 10A	S-K18	S-K21	S-K21	2	2
	0.2	FR-U110W-N/0.2K, -(UL)	BH-K model, NV30 model 15A	S-K21	S-K25	S-K25	2	2
	0.4	FR-U110W-N/0.4K, -(UL)	BH-K model, NV30 model 20A	S-K21	S-K25	S-K50	2	2

Power input	Motor output (kW)	Applicable inverter model	Power factor improvement AC reactor	Low-acoustic noise output reactor	Fuse Rating	
					Class	Amp./Volt
3-phase 200V	0.1	FR-U120-N)0.1K-(c), -(UL)	FR-BAL-0.4K (Note 4)	FR-BOL-0.4K	K5 or H	3A/250V
	0.2	FR-U120-N)0.2K-(c), -(UL)	FR-BAL-0.4K (Note 4)	FR-BOL-0.4K	K5 or H	5A/250V
	0.4	FR-U120-N)0.4K-(c), -(UL)	FR-BAL-0.4K	FR-BOL-0.4K	K5 or H	8A/250V
	0.75	FR-U120-N)0.75K-(c), -(UL)	FR-BAL-0.75K	FR-BOL-0.75K	K5 or H	15A/250V
	1.5	FR-U120-N)1.5K-(c), -(UL)	FR-BAL-1.5K	FR-BOL-1.5K	K5 or H	25A/250V
Single phase 200V	0.1	FR-U120S-N)0.1K, -(UL)	FR-BAL-0.4K (Note 4)	FR-BOL-0.4K	K5 or H	5A/250V
	0.2	FR-U120S-N)0.2K, -(UL)	FR-BAL-0.4K (Note 4)	FR-BOL-0.4K	K5 or H	8A/250V
	0.4	FR-U120S-N)0.4K, -(UL)	FR-BAL-0.75K (Note 4)	FR-BOL-0.4K	K5 or H	15A/250V
	0.75	FR-U120S-N)0.75K, -(UL)	FR-BAL-1.5K (Note 4)	FR-BOL-0.75K	K5 or H	25A/250V
Single phase 100V	0.1	FR-U110W-N)0.1K, -(UL)	FR-BAL-0.4K (Note 4)	FR-BOL-0.4K	K5 or H	8A/250V
	0.2	FR-U110W-N)0.2K, -(UL)	FR-BAL-0.75K (Note 4)	FR-BOL-0.4K	K5 or H	15A/250V
	0.4	FR-U110W-N)0.4K, -(UL)	FR-BAL-1.5K (Note 4)	FR-BOL-0.4K	K5 or H	25A/250V

(Note)

1. The wiring sizes are shown for a 20m length.
2. When installing an MC on the inverter power supply, select the model according to power supply capacity and wiring distance as shown on the right.
The A, B, C areas in the figure correspond to those in the above table. S-K10 is selected when using a power factor improvement reactor FR-BAL on the 0.4 to 1.5K models.
3. Use a $\phi 0.4$ to $\phi 1.0$ solid wire or 0.3 to 0.75mm² stranded wire for the control lead.
4. The power factor may drop slightly below 0.9.

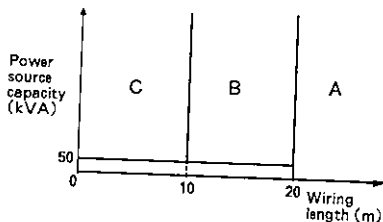

(Note)

The figure shown is based upon wire sizes recommended in the above table.

- An excessive peak current will flow to the power supply input circuit when the inverter is directly connected to a large capacity power supply transformer (500kVA or more, wiring 10m or less), and the inverter may be damaged. Always install the optional power factor improvement reactor FR-BAL in this case. (Use the 0.4kW FR-BAL for 0.1K and 0.2K.)

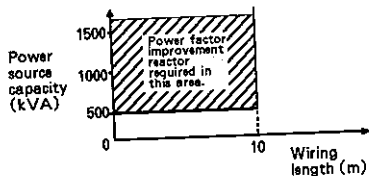

- The wiring length between the inverter and motor must be less than 100m. The control line must be 30m or less and must be separated from the main power wire. Use a twisted pair wire for external frequency setting signal input.
- Connect as shown below when installing.

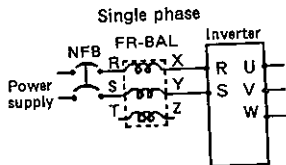
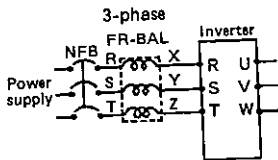

Revision

Publication date	Instruction manual No.	Details of revision
AUG. 1993	IB(NA)•66425-A	First edition
SEPT. 1993	IB(NA)•66425-B	Addition : Single phase power supply version Low-acoustic noise version Fully closed Version
JAN. 1994	IB(NA)•66425-C	Addition : Page 2. 9. 18
NOV. 1994	IB(NA)•66425-D	Partly revised (A5 size → A6 size)
MAR. 1995	IB(NA)•66425-E	Addition : Page 20. 46. 47. 48. 51
JULY. 1995	IB(NA)•66425-F	Addition : Stop key function, Pr.75



MITSUBISHI ELECTRIC CORPORATION

HEAD OFFICE: MITSUBISHI DENKI BLDG. MARUNOUCHI TOKYO 100 TELEX: J24532 CABLE MELCO TOKYO

TYPE	FR-U120 EIBUN TORISETU
CODE	.1A2-G32

IB(NA)68425-F(9509)ROD Printed in Japan

Specifications are subject to change without notice.