

MAINTENANCE MANUAL FOR
Servopack[®]



Sept., 1979

TYPE CPR-QR□

1. GENERAL

The Type CPR-QR□ SERVOPACK is a control unit of adjustable frequency inverter drive to provide a highly accurate, wide range of adjustable speed of Yaskawa AC motors. It is ideally suited for various application requiring maintenance-free, constant motor output, and exacting speed control, such as main spindle drive for NC machine tools.

The control section of the Servopack consists of a speed loop, a current loop, and a control power supply section. As the Servopack is based on a power transistorized pulse width modulation (PWM) inverter circuit consisting of power transistors, its current waveform is sinusoidal and is free from high harmonics, unlike conventional inverter controls based on square voltage or current waveform. This results in substantial freedom from torque ripples.

The most important feature of the Servopack is that even a conventional AC motor can be operated with performances equivalent to those of DC motors. The vector control of the Servopack makes the exciting current component and the secondary current component flow at right angles both in static- and transient-base so that current reference becomes equal to torque reference.

Line id: @zzzz

www.repairtw.com

Table of Contents

	Page
1. GENERAL	1
2. SPECIFICATIONS AND TYPE DESIGNATION	2
3. OPERATING PRINCIPLE	4
4. CIRCUIT CONFIGURATION	6
5. ADJUSTMENT	9
6. TROUBLESHOOTING	24
7. CONNECTION DIAGRAM	29
8. PARTS ARRANGEMENT	31
9. MAIN PARTS LIST	34

2. SPECIFICATIONS AND TYPE DESIGNATION

2.1 Specifications

Table 1 Specifications of Type CPCR-OR Servopack

Type Name	CPGR-QR756SC-4K CPCR-OR756SC-4KB	CPCR-QR756SC-2K CPCR-OR756SC-2KB
Applicable Motor	UAASE-5K, 3.5 kW, 850 rpm	UAASE-5K, 3.5 kW, 750 rpm
Power Supply	3-phase, 200/220 VAC, $\pm 10\%$, 50/60Hz	
Power Supply Capacity	11 kVA	
Main Circuit	3-phase, full wave rectification. Transistorized PWM inverter.	
Maximum Output Voltage	160 V	
Maximum Peak Output Current (Torque)	32 A, 15-min rating (6 kg-m)	32 A, 30% ED (7.15 kg-m)
Continuous Output Current	24.5 A, (4 kg-m)	24.5 A, (5.1 kg-m)
Internal Current Limit Range	10 - 32 A	
External Current Limit Range	4 - 32 A	
Speed Control Range	30, 120-4000 rpm	32, 95-2000 rpm
Speed Fluctuation	Load Fluctuation	$\pm 0.5\%$, Load fluctuation: 10C.7
	Voltage Fluctuation	$\pm 0.5\%$, Current fluctuation: 10%
Input	Rated Speed Reference Voltage	± 10 VDC
	Resistance	15 k-ohms
	Rated Speed Reference Voltage	$\pm 6.5 - \pm 30$ VDC
Auxiliary Input	Resistance	9.4 - 50 k-ohms
	Speed Detection	Resolver: 12.5 kHz, ± 3.5 kHz
Built-in Speed Reference Power Supply	± 12 V, 10 mA	
Ambient Temperature	0 - 55°C (at panel inside)	
Applicable Load GD ²	-	-

Table 1 Specifications of Type CPR-QR Servopack (Cont'd)

Type Name	CPCR-QR756SC-4K CPCR-QR756SC-4KB	CPCR-QR756SC-2K CPCR-QR756SC-2KB
Mounting	Base mounting	
Acceleration/ Deceleration Adjustment	1, 2, 3 Seconds/0 = ±10 V reference DIC switching.	
Additional Functions	Speed Concordance Detection	±15%, Variable to - 35% in one direction
	Zero Speed Detection	±15 - ±20 rpm
	Excessive Deviation Detection	-15%, Variable between -30 and 70%
	Speedometer Drive Output	1 mA DC/full scale
	Accel./Decel. Time 60% Reference	-
2.2 Protective Functions	<p>電話： 037-466333</p> <p>Email: service@repairtw.com</p> <p>Line id: @zzzz</p>	
2.2.1 Motor	<p>Overload Protection Thermal protector: tripping at 155°C</p> <p>www.repairtw.com</p>	
2.2.2 Control unit.	<p>Overspeed Protection Overspeed detection: 120 - 130% rated speed.</p> <p>The following also available by this circuit:</p> <ul style="list-style-type: none"> o Breaking of resolver detection circuit. o Stop of clock frequency. <p>Power Transistor Protection Transistor overcurrent detection/protection.</p> <p>Abnormal Regenerative Voltage Excessive load GD² detection.</p> <p>Fan Stop, Power Transistor Overheating Heat sink temperature detection: 85°C</p>	

2.3 Type Designation

Servopack types are designated in accordance with the following system. When replacing circuit boards, pay attention to the type designation of your unit.

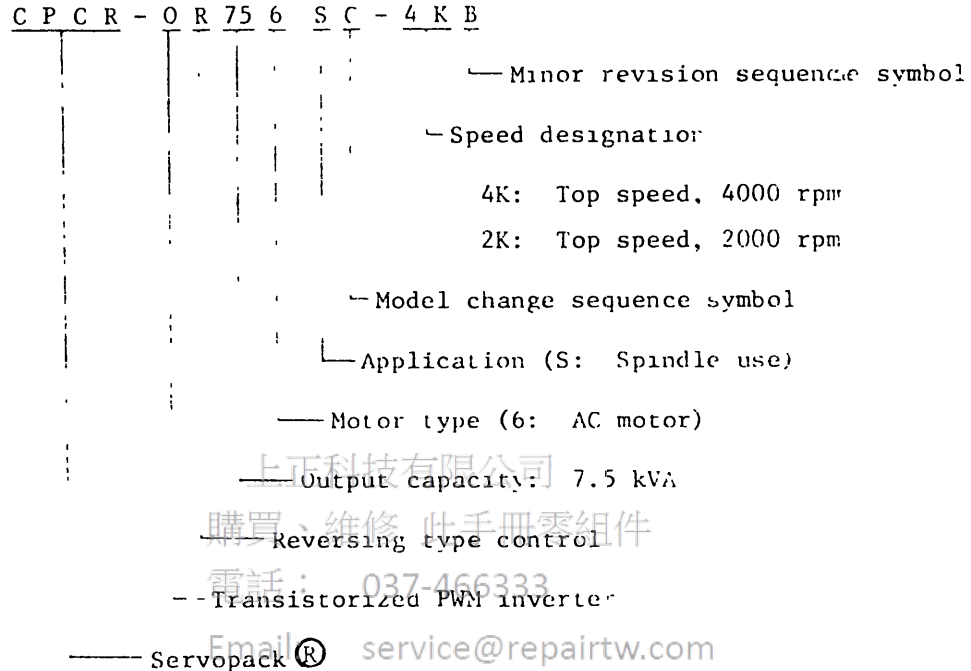

上正科技有限公司
 購買、維修、此手冊零組件
 電話：037-466333
 Email: service@repairtw.com
 Line id: @zzzz

3. OPERATING PRINCIPLE

3.1 Synchronous Speed and Actual Speed

The actual speed of 3-phase induction motors remains behind by the slip from the synchronous speed when they are operated under the control of Servopack units.

3.2 Synchronous Wattage and Vector Control

Fig. 1 shows an equivalent circuit to one of three phases of an induction motor. Where disregarding the secondary leakage inductance, primary winding resistance, and the primary leakage inductance to simplify the explanation the total power consumption in r_1/s of the three phases is deemed as the same with the secondary input, and $(1-S)$ times the secondary input is the mechanical output P_M .

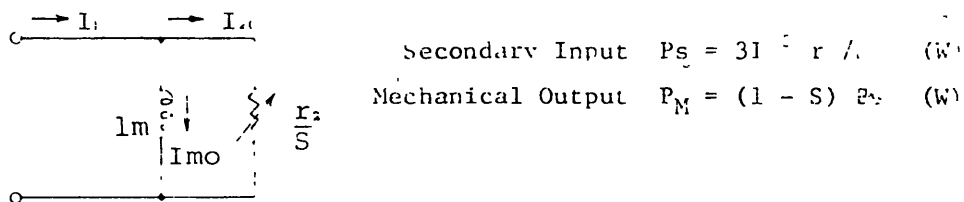

Fig. 1 Equivalent Circuit

The torque T generated by a motor is given by

$$\text{Torque } T = P_M / \omega_m = P_s / \omega_s \quad (\text{N-m})$$

Where $\omega_s = 2\pi f / P$ (synchronous angular velocity)

With induction motors, P_s is sometimes adopted as the value representing torque, and $T = P_s$ (synchronous wattage) is known as synchronous wattage torque. The relationship between the primary current I_1 and generated torque T of a motor is given by,

$$T = \frac{3P}{\omega} \cdot \frac{(\omega \lambda_m^2) (r_2/S)}{(r_2/S)^2 + (\omega \lambda_m)^2} \cdot I_1^2$$

$$\text{Where, } I = \sqrt{I_{m0}^2 + I_{2c}^2}$$

$$S\omega = r_2 I_{2c} / \lambda_m I_{m0} \quad (\omega \lambda_m I_{m0} = \frac{E_s}{S} I_{20})$$

Then,

$$T = 3p \lambda_m I_{m0} I_{20}$$

上正科技有限公司
購買、維修 此手冊零組件

電話： 037-466333

This indicates that, with the exciting current I_{m0} of an induction motor maintained at a constant level, and the slip angle frequency $S\omega$ is controlled in proportion to the secondary current I_{20} , the torque varies in proportion to the secondary current I_{20} , and the Servopack is equivalent to the control of DC motors in all respects. The speed n (rpm) of a motor is given by,

$$n = (1 - S) n_s$$

$$n_s - n = S n_s$$

$$f_s - f_R = \text{Slip } f$$

$$\omega_s - \omega = S\omega$$

$$= \frac{r_2}{\lambda_m I_{m0}} I_{2c}$$

$$= k I_{2c}$$

Torque T

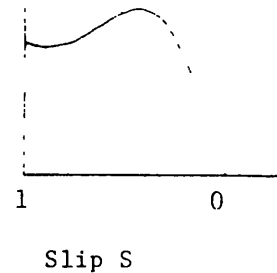

Therefore,

$$\omega_s = \omega + k I_{2c}$$

When a slip frequency signal component which is proportional to the required load torque is added to the motor speed frequency signals detected by the resolver, and the sum signals are used as the primary exciting speed reference signal, the motor speed can be maintained at a constant level despite of fluctuations in the torque due to load. With the vector control, the amplitude of the primary current (I_1) is controlled to a value equal to the vector sum of the secondary current (I_2) corresponding to the load torque, and the field exciting current (I_m) of the motor. At the same time the angular velocity (ω_s) of the primary current is also controlled to a value that is equal to the sum of the angular velocity of the control speed plus the slip in proportion to the required load torque.

4. CIRCUIT CONFIGURATION

Shown in Fig. 2 is a block diagram of the circuit of Servopack.

4.1 Main Circuit Section

The main circuit consists of a converter section to transform the 3-phase AC voltage into a DC voltage, and a PWM transistor inverter section for inverting the DC voltage into variable-frequency voltages.

4.2 Current Loop Section

This section is to supply the primary speed reference current:

With amplitude of $I_1 = \sqrt{I_m^2 + I_2^2}$

And frequency of $f_s = f_R + \text{Slip} (=kI_2)$

that is sent out from the vector control circuit in LPWB to the motor.

The speed reference current is supplied in two phases. For current detection, the 3-phase current is converted into 2-phase current by means of an insulated isolator which takes out the U and V phases out of the three phases, and the 2-phase current is compared with the speed reference current in a 2-phase current amplifier.

The 2-phase speed reference current is then converted into 3-phase current, and amplified phase by phase in pulse-width-modulated control, by means of base drivers, each of which is serving individual power transistors.

4.3 Vector Control Section

The Servopack control unit employs a multi-pole resolver in order to detect the speed feedback signals of AC motors.

To utilize the revolution frequency signals detected by the multi-pole resolver in obtaining exciting current frequency reference signals, they are converted into analogue voltage speed feedback signals.

The differential signals (ω_r) between the speed reference voltage and speed feedback voltage is used as the torque reference signal, and leads the exciting current reference signal by a phase angle of 90° in the secondary current reference circuit. In the exciting current reference circuit, slip frequencies proportionate to the torque reference signals are added to the detected revolution frequency signals to obtain the frequencies of the primary speed reference current.

Stepped speed reference voltages are converted into ramp form voltages by a linear acceleration-deceleration circuit. Time limit is selectable among anyone of 1, 2 and 3 seconds.

上正科技有限公司
購買、維修 此手冊零組件
電話： 037-466333
Email: service@repairtw.com
Line id: @zzzz
www.repairtw.com

Fig. 2 Block Diagram of Servopack

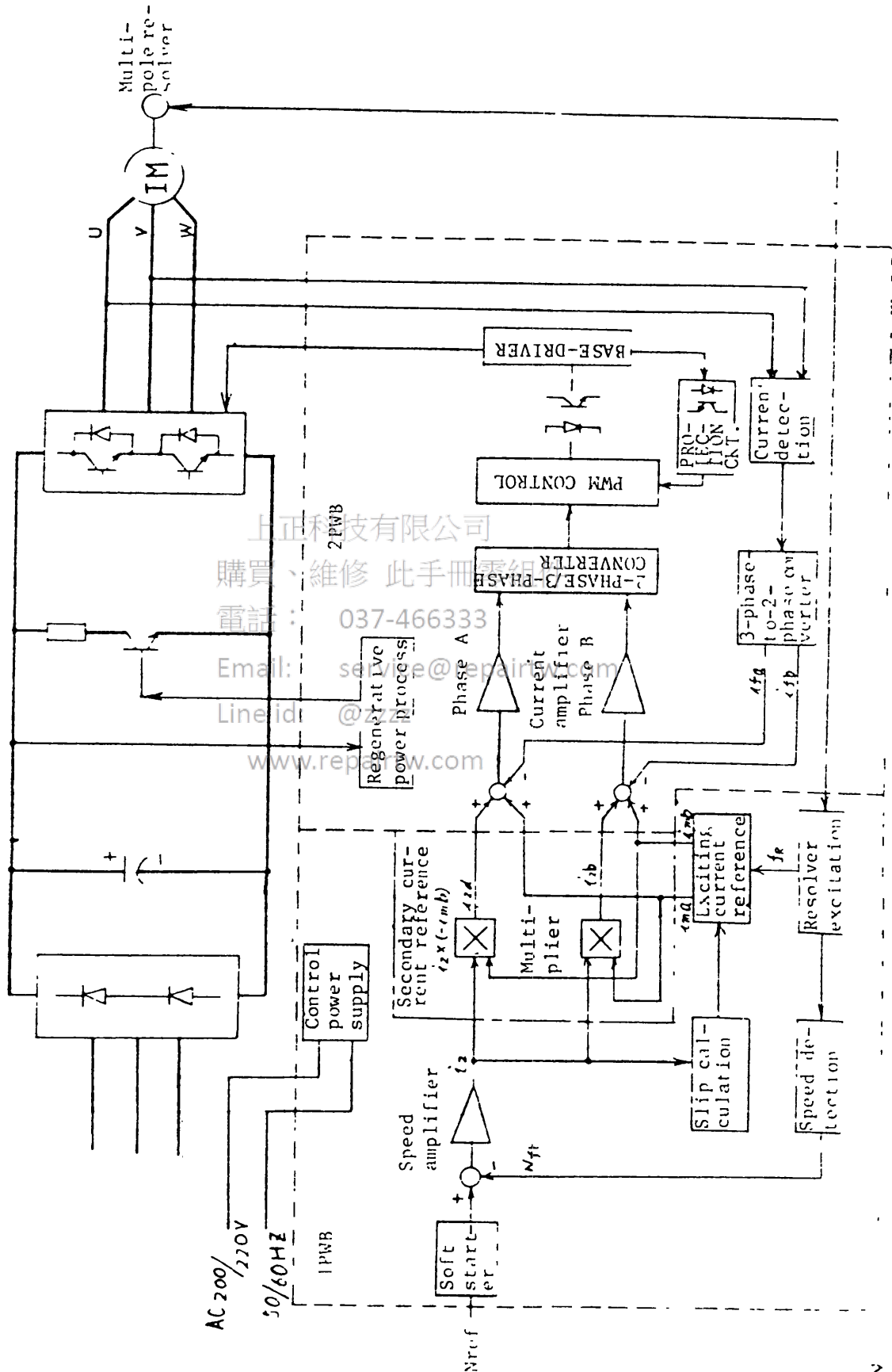

上正科技有限公司
 購買、維修 此手冊
 電話：037-466333
 Email: service@repair.com
 Lineid: @4222
 www.repair.com

5. ADJUSTMENT

5.1 External Terminal List

	Terminal Symbol	Name	Description
MAIN CIRCUIT	R, S, T	Main Power Input	3-phase 200/220 VAC $\pm 10\%$, 50/60 Hz.
	r, t,	Control Power Input	Single phase, 200/220 VAC $\pm 10\%$, 50/60 Hz
	U, V, W	Motor Connection	Connect U, V, and W to the corresponding motor terminals.
	R ₁ , R ₂	Resistor Connection	Connected before shipment.
CONTROL CIRCUIT	C5, C6	Thermal Protector Connection	Connect to motor incorporated thermal protector. C5: Motor 1, C6: Motor 1b.
	C7, C8	Spindle Condition Detection	Normal condition: Normally open.
	C9, C10	Spindle Control Abnormal Detection	Detection of spindle control circuit abnormal condition: Normally closed.
	1 2	Speed Reference Input	With 2 connected to 0V, rated speed at 10 V.
	3 4	Resolver Input	With 4 connected to 0V, connect: 3 to resolver terminal C, and 4, to .
	5 6	Resolver Phase A Excitation	With 6 connected to 0V, connect: 5 to resolver terminal A, and 6, to D
	7 8	Resolver Phase B Excitation	With 8 connected to 0V, connect: 7 to resolver terminal B, and 8, to D.
	E	Grounding	Connect E to resolver terminal E and ground it.
	9 2	Auxiliary Input	Use these terminals when obtaining the rated motor revolution at voltages (6.5 - 30 V) other than rated reference voltage (10 V). CAUTION REQUIRED!!
	10, 11 12	$\pm 12V$ Output	Connect 11 to 0V common, 10 to +12V, 12 to -12V. 10 mA can be supplied. Usable for speed setting, etc.
13	Control Stop Input	When 13 is closed to 0V terminal 11, the control operations are forced to stop.	
14 15	Forward Run Torque Limit	When 14 and 15 are closed, torque limitation start. (Torque limitation impossible on reverse run.)	

Terminal Symbol	Name	Description
16 17	Start Interlock	Closing 16 and 17 starts control. Opening 16 and 17 stops control.
18 19	Output for Tachometer	DC 1 mA with 18 negative and 19 positive.
20 21	Zero Speed Detection	When 20 and 21 are closed, zero speed.
22 23	Speed Concordance Detection	When 22 and 23 are closed, speed conforms.
24 25	Excessive Deviation Detection	When 24 and 25 are closed, excessive deviation.
26	Time Limit 60% Reference	When 26 and 12 are closed, acceleration and deceleration time becomes 60%. (Use is prohibited for 1 second setting.)

5.2 Potentiometer Adjustment

5.2.1 1 PWE

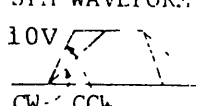
POT.	Sym- bol	Functions	Adjustment	Change of Characteristics by Adjustment
IN-OFS	16VR	Offset adjustment of soft start circuit.		
TIME	17VR	Time limit adjustment.	Turn CW for increasing time. Turn CCW for shortening time.	SFM WAVEFORM  10V CW CCW Never make setting for 1 second or less.
TIME SELECT	1DiC	Selection of time limit	Selectable among the three steps, 1S, 2S, and 3S.	With 1S shorted: 1 sec. With 2S shorted: 2 sec. With 3S shorted: 3 sec. The time limits are set at 0 to 10 V.

Pot.	Sym	Functions	Adjustment	Change of Characteristic by Adjustment
FB-AJ	2VR	Motor speed fine adjustment	(CAUTION) Adjust so that the motor reaches rated rpm, with the rated speed reference voltage ± 10 V applied across the terminals 1 and 2.	
OFS-AJ	4VR	Speed amplifier offset adjustment.	CW: Reverse run. CCW: Forward run.	
C-LIM	5VR	Current limit adjustment.	CW: Current increases. CCW: Current decreases.	At SPM voltage. CPCR-QR756SC-4K ± 6 V max., CPCR-QR756SC-2K ± 6.5 V max.
TOL-L	12VR	Torque setting when limiting torque (current) on external	CW: Current increases. CCW: Current decreases.	
SPD-BAL	8VR	Zero adjustment of speed feedback voltage.	CW: TG-M voltage shifts towards -. CCW: TG-M voltage shifts towards +.	With the motor at standstill, set so that ± 2 mV obtained across terms TG-M and OV.
GAIN	18VR	Gain adjustment of speed feedback voltage detection circuit.	CW: TG-M voltage decreases. CCW: TG-M voltage increases.	± 6.4 VDC at rated motor speed operating on TG-M voltage.
A-BAL	9VR	Balance adjustment of resolver exciting voltage.	Adjust the A-res voltage to the same level as B-res voltage.	Approx. ± 5.6 Vp, 12.5 kHz at A-res and B-res voltages

上正科技有限公司
 購買、維修 此手冊零組件
 電話： 037-466333

Email: service@repairtw.com
 Line id: @zzzz
www.repairtw.com

Pot.	Sym- bol	Functions	Adjustment	Change of Characteris- tice by Adjustment
SI-F	6VR	Slip frequency adjustment.	CW: Slip frequency increases. CCW: Slip frequency decreases.	CPCR-QR756SC-4K at SPM=6V, SLF-M=4.4 kHz ($\tau=225$ s). CPCR-QR 756SC-2K at SPM=0.5V, SLF=M5.10 kHz ($\tau=194$ s).
A-AJ	7VR	Exciting current reference adjustment	CW: Exciting current increases. CCW: Exciting current decreases.	I_{MA}, I_{MB} $\pm 3Vp$
AGREE	14VR	Speed concordance detection adjustment.	-	Adjust so that absolute values of TG-M and AGR-M voltage become equal.
AGR-AJ	20VR	Adjustment of speed concordance detection point.	CW: Concordance point rises. CCW: Concordance point falls.	DETECTION POINT 100% _____ 90% _____ 80% _____ 65% _____ 0 1/4 2/4 3/4 4/4 VR SCALE → Shipped at 80%-2/4 scale setting
Z-SPD	13VR	Zero speed detection point adjustment.	CW: Detection point rises. CCW: Detection point falls.	-
DEV-A	19VR	Excess deviation detection point adjustment.	CW: Detection point rises. CCW: Detection point falls.	80 _____ 70 _____ 50 _____ 40 _____ 30 _____ 0 1/4 2/4 3/4 4/4 VR SCALE → Shipped at 50%-1/4 scale setting

上正科技有限公司
 購買、維修 此手冊零組件
 電話: 037-466333
 Email: service@repairtw.com
 Line id: @zzzz
 www.repairtw.com

Pot.	Sym- bol	Functions	Adjustment	Change of Characteris- tice by Adjustment
METER	15VR	Tachometer scale adjustment.	CW: Meter needle Lowers. CCW: Meter needle Rises.	External output current: DC 1mA, at full scale 1mA
INPUT	1VR	Speed reference input voltage adjustment.		Effective only when the terminal (9) is used as input terminal but speed concordance and excessive deviation are not detected.



5.2.2 2PWB

UC-Z	3VR	Zero adjustment of phase U current detection isolator.	-	Adjust within $\pm 1mV$ at 0A.
VC-Z	5VR	Zero adjustment of phase V current detection isolator.	-	Adjust within $\pm 1mV$ at 0A.
UC-AD	2VR	Sensitivity adjust- ment of phase U current detection isolator.	CW: Gain increases. CCW: Gain decreases.	Adjust to 0 V/A.
VC-AD	4VR	Sensitivity adjust- ment of phase V current detection isolator.	CW: Gain increases. CCW: Gain decreases.	Adjust to 0 V/A.
OFF-1	8VR	Offset adjustment of phase A current amplifier.	-	Adjust so that the I _u component of phase U and V currents are removed.
OFF-2	9VR	Offset adjustment of phase B current amplifier.	-	Mutual interference occurs.
OV-A	1VR	Adjustment of over- voltage protection detection level.	(CAUTION) Do not tamper with this potentiometer.	<p>_____ N RPM</p> <p>----- 0 RPM</p> <p>----- 375 - 3800</p> <p>----- 270V</p> <p>Voltage across O₂ and O₁</p>

5.3 Check Terminals

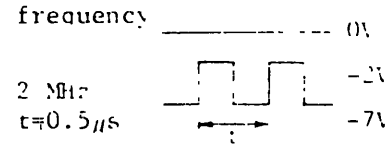
5.3.1 1PWB

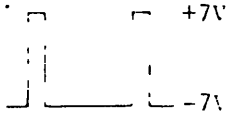
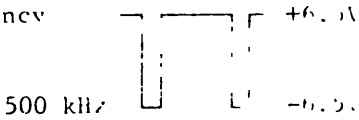
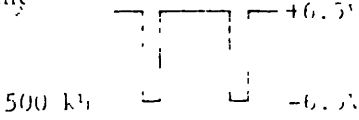
Symbol	Name	Description
0V	SIGNAL GROUND	0V terminal for waveform monitoring.
iN-M	INPUT MONITOR	For monitoring speed reference input waveform 0 to $\pm 10V$. Monitoring is possible only when input is applied to terminal 1.
SFM	SOFT START OUTPUT MONITOR	For monitoring output waveform of soft start circuit 0 to $\pm 10V$.
SPM	SPEED AMP MONITOR	For monitoring speed amplifier output, i.e., torque reference waveform 0 to $\pm 6.5V$.
i2A		Phase A secondary current speed reference voltage 0 to $\pm 3.5V$.
i2B		Phase B secondary current speed reference voltage 0 to $\pm 3.5V$.
A-RES EXCITING VOLT MONITOR	RESOLVER-A EXCITING VOLT MONITOR	For monitoring resolver phase A exciting voltage $\pm 5.6 V_p$, 12.5 kHz. A leads B by a phase angle of 90° .
B-RES EXCITING VOLT MONITOR	RESOLVER-B EXCITING VOLT MONITOR	For monitoring resolver phase B exciting voltage $\pm 5.6 V_p$, 12.5 kHz. B lags behind A by a phase angle of 90° .
O-RES SIGNAL MONITOR	RESOLVER SIGNAL MONITOR	For monitoring resolver detection signal $\pm 0.2V_p$, 12.5 kHz, ± 3.5 kHz.
THITA	O-RES MONITOR	For monitoring shaped waveform of resolver detection signal $\pm 7 V_p$, 12.5 kHz, ± 3.5 kHz.
TG-M VOLT MONITOR	SPEED FEEDBACK VOLT MONITOR	For monitoring speed feedback voltage $\pm 6.4V/\pm 4000$ rpm, $\pm 6.4V/\pm 2000$ rpm.
CF	CLOCK FREQUENCY MONITOR	For monitoring clock frequency
		
+5V	C.F OSC POWER SOURCE MONITOR	For monitoring power source of clock oscillator.
MI	MULTIPLIER FREQUENCY OSC MONITOR	For monitoring multiplier sixteen oscillator. 15 kHz. $t=66.7\mu s$

Symbol	Name	Description
IM-A	EXCITING CURRENT-A SIGNAL MONITOR	Phase A exciting current reference voltage $\pm 3 V_p$, 0 to 133 Hz. $f = \frac{4 \times N \text{ rpm}}{120} \quad (\text{Hz})$
IM-B	EXCITING CURRENT-B SIGNAL MONITOR	Phase B exciting current reference voltage $\pm 3 V_p$, 0 to 133 Hz. $f = \frac{4 \times N \text{ rpm}}{120} \quad (\text{Hz})$
SLF-M	SLIP FREQUENCY MONITOR	For monitoring slip frequency. Refer to SL-F above for frequency. 
AGR-M	AGREEMENT MONITOR	For monitoring when adjusting AGREE (14V). The voltages at TG-M and AGR-M are equal in their absolute values.
+12V		For monitoring +12V control power source voltage. $+12V \pm 0.5V$.
-12V		For monitoring -12V control power source voltage. $-12V \pm 0.5V$.
+7V		For monitoring +7V control power source voltage. $+6$ to $+6.5V$.
-7V		For monitoring -7V control power source voltage. -6 to $-6.5V$.
A		For monitoring reference wave of resolver phase A exciting voltage $\pm 6.5 V_p$, 12.5 kHz. A leads B by a phase angle of 90° .
B		For monitoring reference wave of resolver phase B exciting voltage $\pm 6.5 V_p$, 12.5 kHz. B lags behind by a phase angle of 90° .
F1		For monitoring slip frequency calculation clock 500 kHz. 
F3		For monitoring slip frequency calculation clock 500 kHz. 
F10		For monitoring slip frequency calculation clock 500 kHz. 

5.4 Adjustment Results

5.4.1 Normal state

1 PWB

. Control Power Source

Name	Normal state	Check point
+12 V	+12 V \pm 0.5 V	+12 V
-12 V	-12 V \pm 0.5 V	-12 V
+7 V	+6 to +6.5 V	+7 V
-7 V	-6 to -6.5 V	-7 V
+5 V	4.4 V to 5.0 V	+5 V

. Oscillator

Clock	Rectangular wave 2MHz (0.5 μ S)	0V	CF
Multiplier	Saw teeth wave \pm 3 Vp \pm 10 \pm V, 15 kHz \pm 1.5 kHz	-2 -7	ML

. Resolver

A excitation	Nearly sine wave	12.5 kHz, \pm 5 to \pm 6 Vp	A-RES
B excitation	Nearly sine wave	12.5 kHz, \pm 5 to \pm 6 Vp	B-RES
0 detection	Sine wave	12.5 kHz, \pm Δ f \pm 1 to \pm 3 Vp	O-RES

Across A and B there is 90° phase difference.

Zero detection leads in phase when motor runs forward (frequency increases).

Zero detection lags in phase when motor runs reverse (frequency decreases).

Relationship between Δ f and motor speed

$$\text{Resolver } \Delta f \quad \text{Motor Primary Current (At no load)} \quad \text{Motor Speed}$$

$$\Delta f \text{ Hz} \quad \times \quad 1/25 \quad = \quad f \text{ Hz} \quad \times \quad 30 \quad = \quad N \text{ rpm}$$

Example: 3000 Hz ————— 120 Hz ————— 3600 rpm
(60 rps)

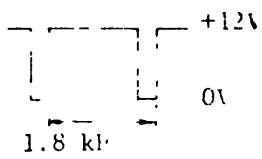
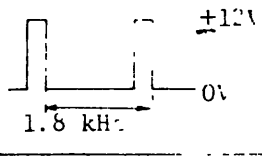
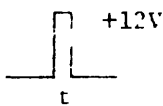
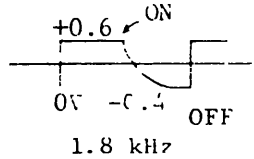
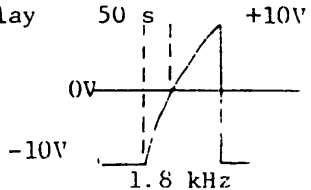
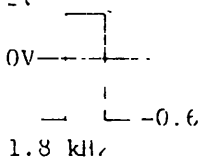
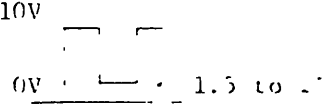
Symbol	Name	Description
CH1U	CURRENT MONI-TOR-U	For monitoring phase U current waveform 0.1 V/A.
CH1V	CURRENT MONI-TOR-V	For monitoring phase V current waveform 0.1 VA.
PF	PWM-OSC MONITOR	For monitoring PWM sawteeth wave oscillator voltage $\pm 3 V_p$, 1.8 kHz.
CH3		For monitoring drive signals for power transistors 1, 3 and 5. 
CH2		For monitoring drive signals for power transistors 2, 4 and 6. 
PR1M		For monitoring detection signals of transistor protection.  OPERATES AT $t \leq 60$
PCM		For monitoring 1 to 6BDR (base drivers) photo-coupler function signals. 
DLYM	Terms for monitoring the power circuit: Measure across terminal 0V. 1BDR, 3BDR and 5BDR have independent terminal 0V.	For monitoring 1 to 6BDR delay waveform. 
CH9		1 to 7BDR base drive signal waveform. 
PR2M		1 to 6BDR protection-detection signal. 

上正科技有限公司
 購買、維修 此手冊零組件
 電話: 037-4863333
 Email: service@repairtw.com
 Line id: @zzzz

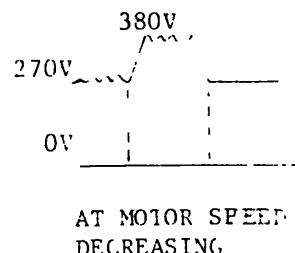
Symbol	Name	Description
EC	Terms. for monitoring the power circuit: Measure across terminal 0V. 1BDR, 3BDR and 5BDR have independent term.0V.	Main DC voltage detection signal. 
+10V		
0V	Terminals for the power circuit:	Four in total: One for each 1BDR, 3BDR, 5BDR. and one in common for 2, 4, 6 and 7BDRs.
-10V	Measure across terminal 0V.	
+5V		For monitoring 7BDR +5V or -5V power source.
-5V		

上正科技有限公司

購買、維修 此手冊零組件

電話： 037-466333

Email: service@repairtw.com

Line id: @zzzz

www.repairtw.com

. Exciting Current Reference Voltage

Name	Normal state	Check Point
Phase A exciting current reference	Sine wave 0 to 134 Hz ± 3 Vp 4000 rpm motor.	1MA
Phase B exciting current reference	Sine wave 0 to 65 Hz ± 3 Vp 2000 rpm motor.	1MB

Phase A and phase B are 90° apart in phase
Lissajous' figure of Exciting current

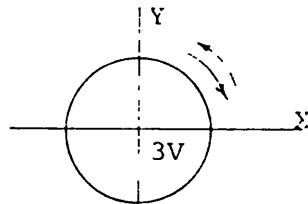

上正科技有限公司

Speed reference +input CW revolution at twice the motor speed.
-input CCW revolution at twice the motor speed.

電話: 037-486333

2 PWB

Email: service@repairtw.com

Line id: @zzzz

. Control power supply

www.repairtw.com

Name	Normal state	Check point
1BDR power supply	+10 V ± 1 V -10 V ± 1 V	1BDR +10 V 0V -10 V
3BDR power supply		3BDR +10 V 0V -10 V
5BDR power supply		5BDR +10 V 0V -10 V
2BDR power supply		
4BDR power supply	+10 V ± 1 V, +5 V ± 0.5 V	2, 4, 6, 7BDR
6BDR power supply	-10 V ± 1 V, -5 V ± 0.5 V	+10 V +5 V V -10 V -5 V 0V
7BDR power supply		

. Oscillator

PWM	Sawteeth wave: 1.8 kHz ± 0.2 kHz ± 3 Vp ± 3 V	'PF'
-----	---	------

5.4.2 Adjustment

- Adjustment of soft start-stop time

With TIME SELECT set to 1S, adjust potentiometer TIME so that output voltage at SFM point comes to rise and fall in 1 second.

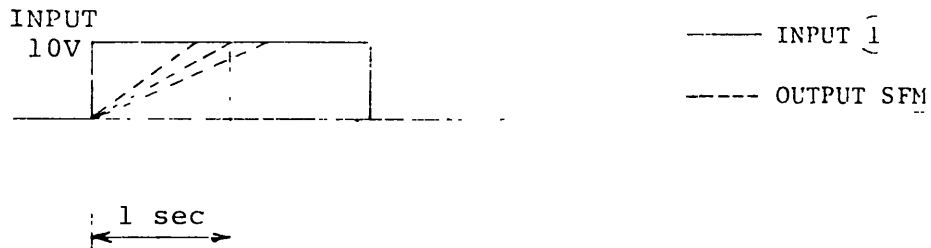

Time can be selected among 1, 2 and 3 seconds with the DIP connector. When the external terminals 26 and 12 are shorted, set time is reduced to 60%.

Note: Do not use at time setting 1 second or shorter.

- When the reference voltage takes some values other than 10V

When a voltage between ± 6.5 and ± 30 V is adopted as the rated speed reference voltage, the terminal (9) is used.

The input voltage is adjusted by input.

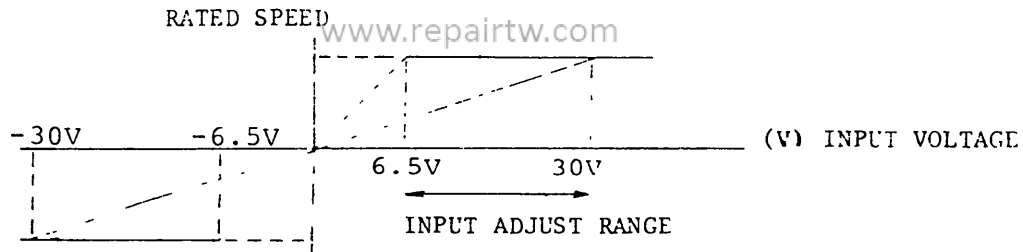

- Zero adjustment of speed feedback voltage

Adjust with potentiometer SPD-BAL until the average value of the TG-M voltages becomes within ± 1 mV when the motor at 0 rpm.

. Torque limiter adjustment

Adjust the torque limiter with the potentiometer TOL-L so as to satisfy the characteristics shown below.

TORQUE

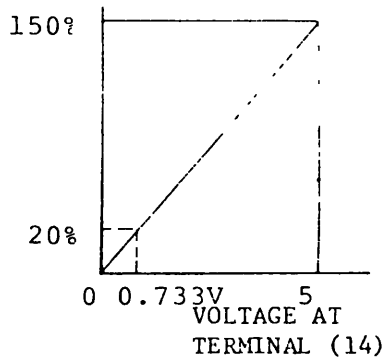

A 4000 RPM MOTOR

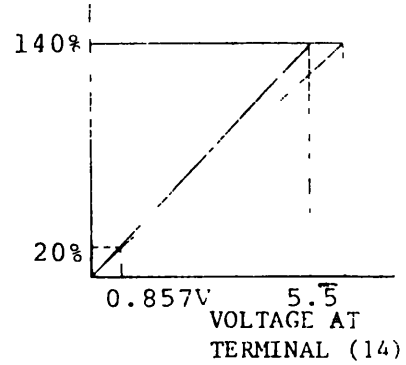

A 2000 RPM MOTOR

. Speed adjustment

上正科技有限公司

購買、維修 此手冊零組件

The fine adjustment of the speed reference voltage and motor speed can be made with the potentiometer FB-AJ. However, when they are adjusted more than $\pm 3\%$ from the adjustment made before shipment, the speed concordance setting becomes incorrect. In this case, DO NOT FORGET TO READJUST THE POTENTIOMETER AGREE REFERRING TO (7).

電話：037-466333

mailto:service@repairtw.com

Line id: @zzzz

. Slip frequency adjustment

www.repairtw.com

With only the control circuit energized, impress the speed reference voltage, and adjust the potentiometer SL-F until the SPM and the SFL-M achieve the conditions shown below.

	CPCR - QR746SC - 4K 4KB		CPCR - QR756SC - 2K 2KB	
SPM	6.0 V	5.0	6.50 V	5.5

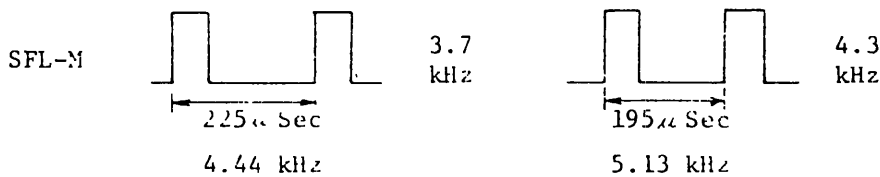

. Speed concordance detection adjustment

With the motor running at the rated speed, or at half the rated speed, adjust the potentiometer AGREE until the absolute values of the IN-M voltage and the AGR-M voltage become equal.

Note: DO NOT CONFUSE THE POTENTIOMETERS AGREE AND **AGR-AJ**.

. Adjustment of speed concordance detection point

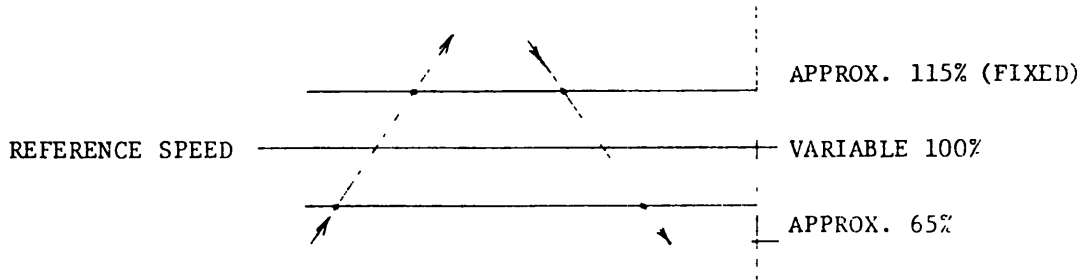

The potentiometer AGR-AJ is for adjusting the concordance point where the motor reaches the reference speed during acceleration as shown above, and the disagreement point where the motor deviates from the reference speed during its deceleration.

Before shipment, it is set to 2/4 graduation and 80%.

電話： 037-466333

AGR-AJ GRADUATION

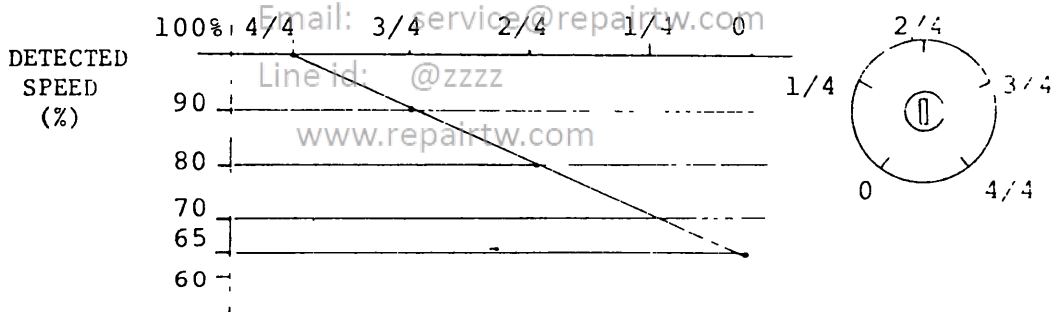

. Zero speed detection

The zero speed detection point is adjusted with the potentiometer **Z-SPN**.

Before shipment the potentiometer is set to 2/4 graduation.

Potentiometer Gradation	0	2/4	4/4
Detected RPM	5-10	15-20	30-35

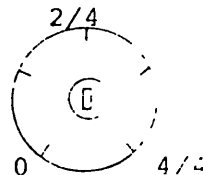

. Excessive deviation detection point

The excessive deviation detection point is adjusted with the potentiometer DEV-A.

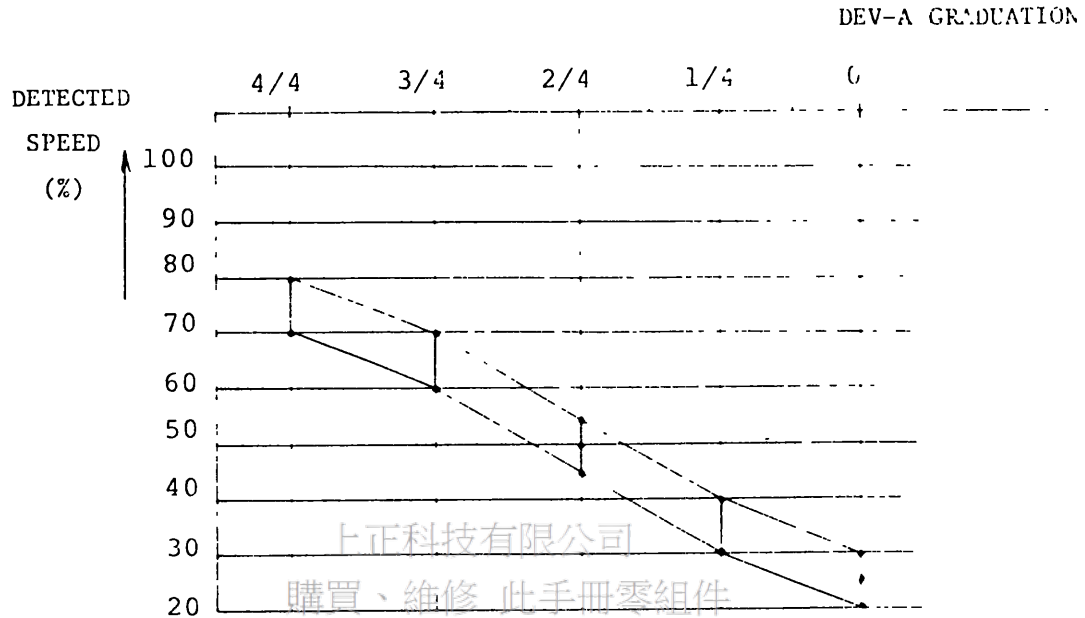

. Reversing direction of rotation

To reverse the motor running direction, interchange the connections of two of the three motor terminals, and simultaneously, reverse the connections of the resolver excitation terminals.

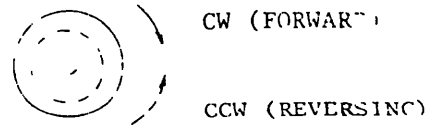
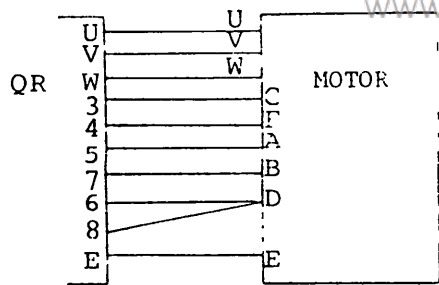

VIEWED FROM OPPOSITE DRIVE END

SPEED REFERENCE (+) ——— CW
 (-) ——— CCW

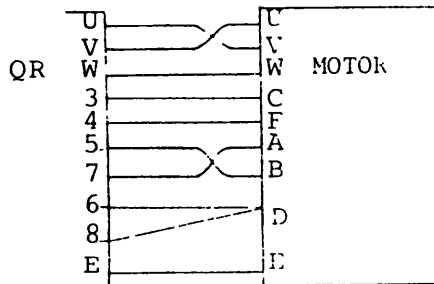

SPEED REFERENCE (+) ——— CCW
 (-) ——— CW

6. TROUBLE SHOOTING

6.1 Trouble Indication and Operation Indication

Name	Indication	Output
Zero Speed	ZERO-S 3 LED	20, - 21, Closed.
Speed Concordance	AGREE 4 LED	22 - 23, Closed.

Name	Indication	Output
Excessive Deviation	-	24, - 25 Closed.
Transistor Protection Excessive Regenerative Voltage	PROTECT 1 LED, and CR2X light.	
Overspeed	OVR-SPD 1 LED, 2 LED, and CR2X light.	C9 - C10 Open. C7 - C8 Closed.
Fuse Blown	IFUX CR2X lights, and CR3X does not light.	
Motor Overheating	CR3X Does not light, and CR5X lights.	C7 - C8 Closed.
Heat Sink Overheating (Fan stops)	CR5X Lights.	C9 - C10 Open.
Regenerative Power Resistor (3R) Overheating	CR2X Lights.	C7, - C8 Closed.

6.2 Symptoms Resulting from Incorrect Connection of Motor Resolver

6.2.1 Motor

Causes	Symptoms
Incorrect connection of phases U, V and W	Even when a speed reference voltage is applied, the motor runs at a speed as low as 75 rpm.

6.2.2 Resolver

Terminal 3 Open	The overspeed protection operates.
Terminal 4 Open	When a speed reference voltage is applied, the motor runs only jerkily.
Terminal 5 Open	When a speed reference voltage is applied, the motor runs at a speed below 100 rpm.
Terminal 7 Open	When a speed reference voltage is applied, the motor runs at a speed below 100 rpm.
Terminal 6 Open	When a speed reference voltage is applied, the motor runs at a speed below 50 rpm.
5 and 7 Reversed	When a speed reference voltage is applied, the motor runs at a speed below 75 rpm.

上正科技有限公司

購買、維修 此手冊零組件

電話： 037-466333

Email: service@repairtw.com

Line id: @zzzz

www.repairtw.com

6.3 TROUBLESHOOTING

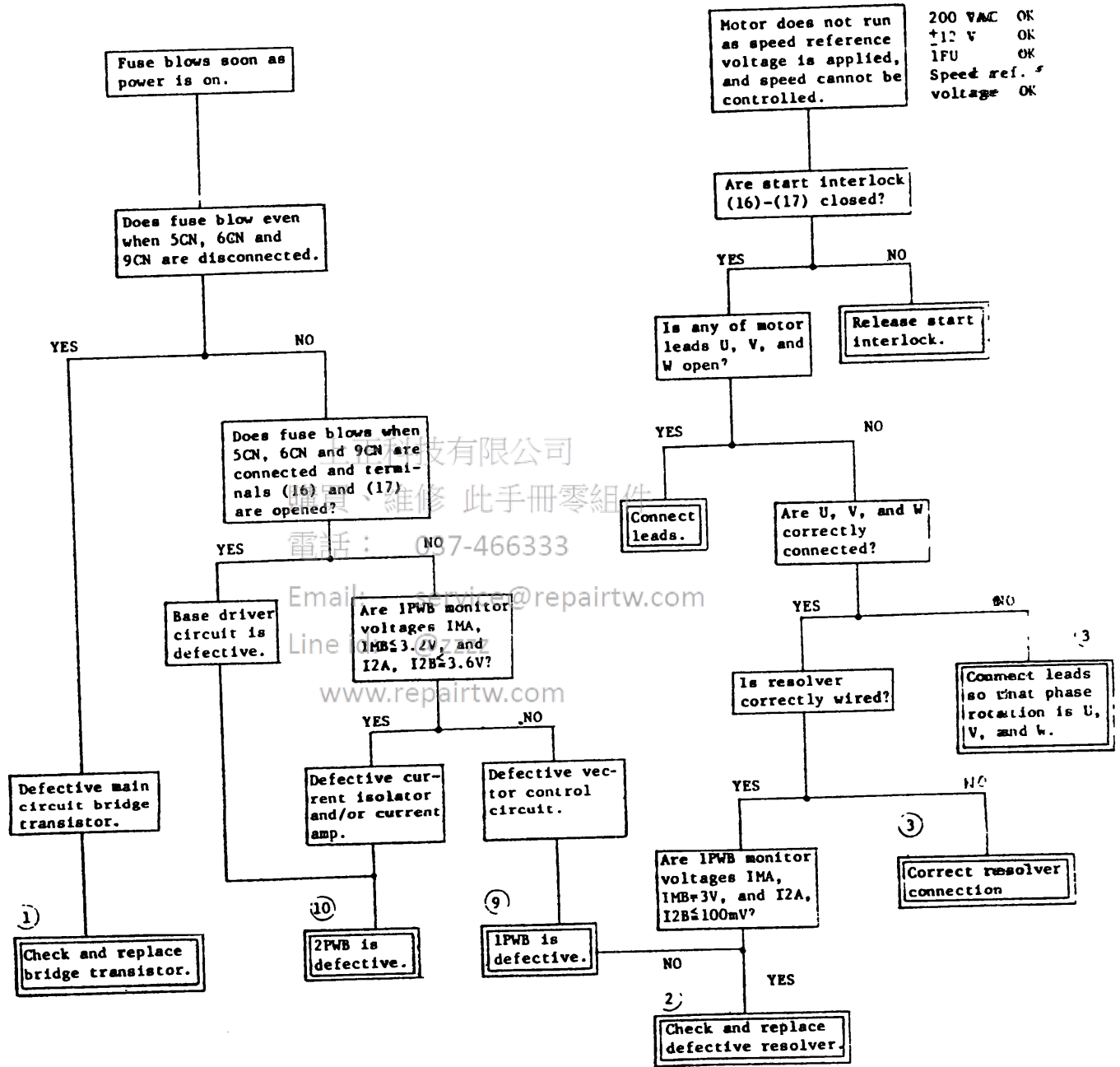

6.3 TROUBLESHOOTING (Continued)

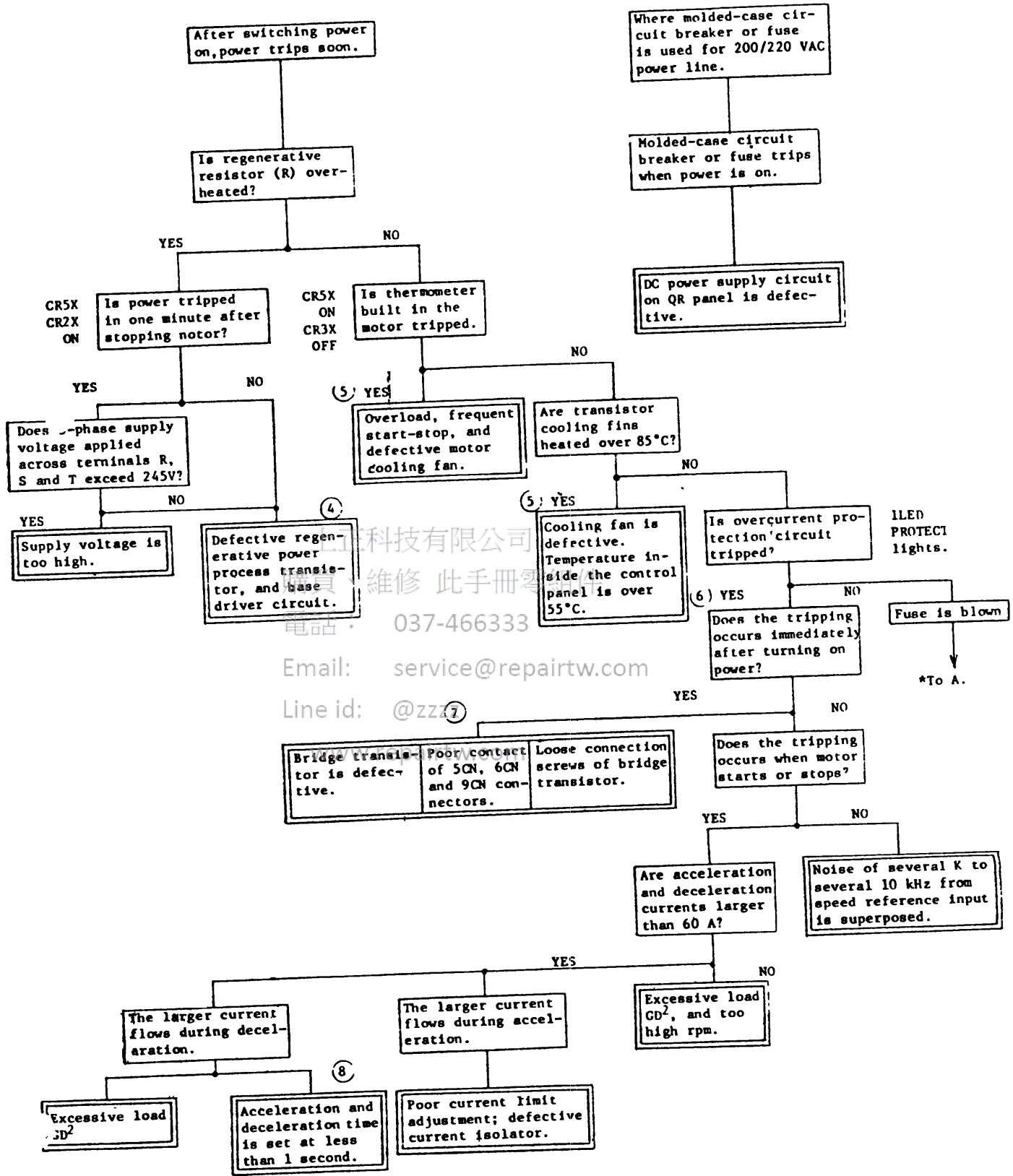

電話: 037-466333
 Email: service@repairtw.com
 Line id: @zz7

7. CONNECTION DIAGRAM

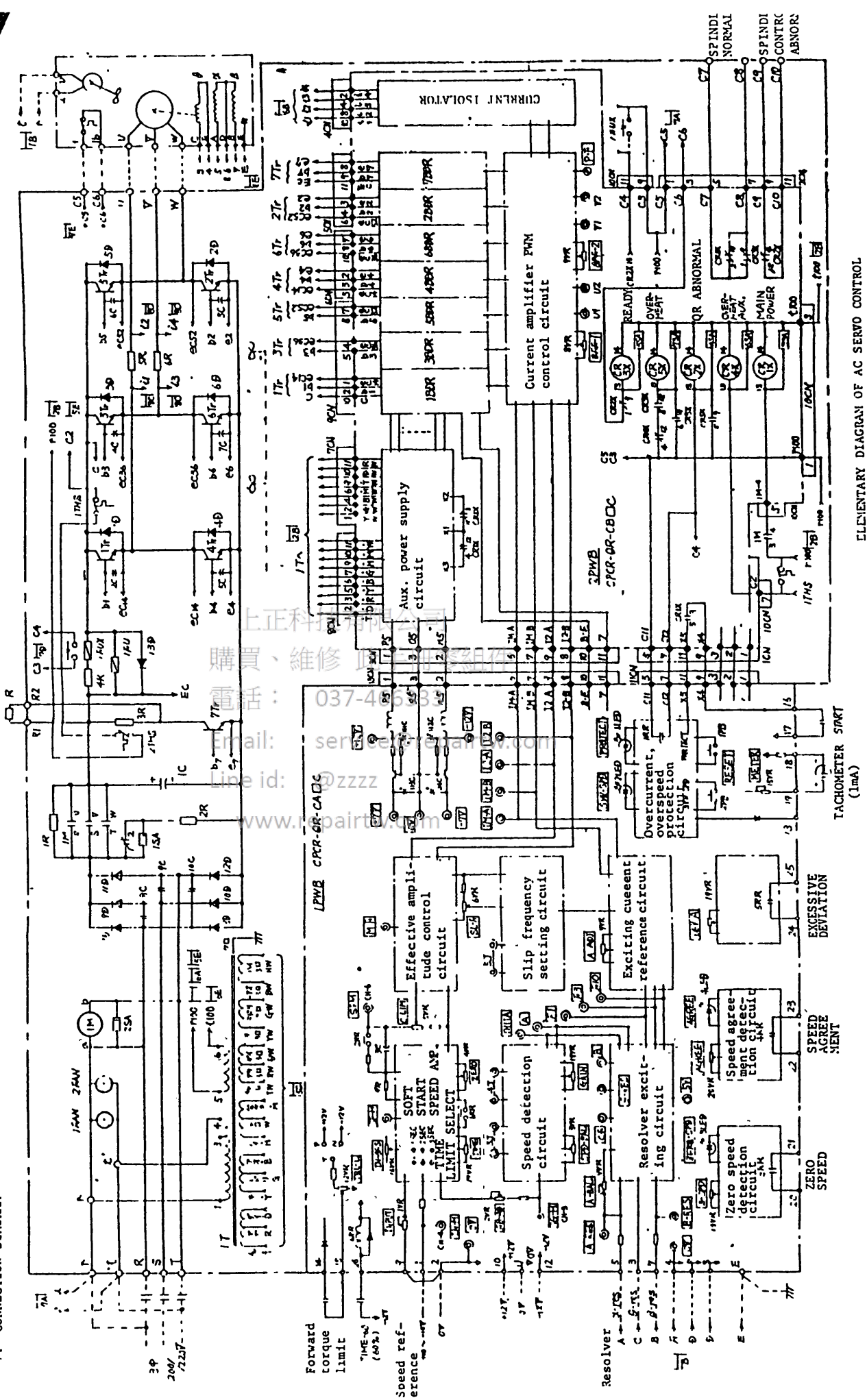

ELEMENTARY DIAGRAM OF AC SERVO CONTROL
LPCR-ORU SC FOR SPINDLE AC CONTROL

8 PARTS ARRANGEMENT

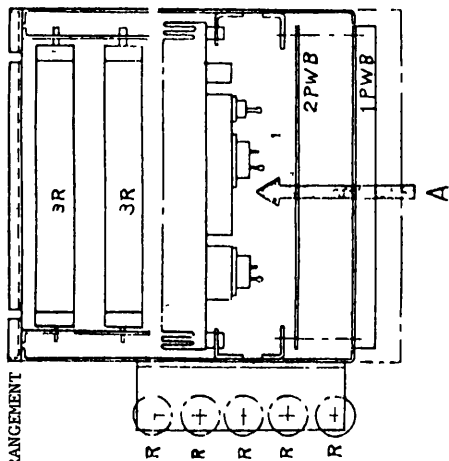

上正科技有限公司
 購買、維修 此手冊零組件
 電話： 037-466333
 Email: service@repairtw.com
 Line id: @zxxx
 www.repairtw.com

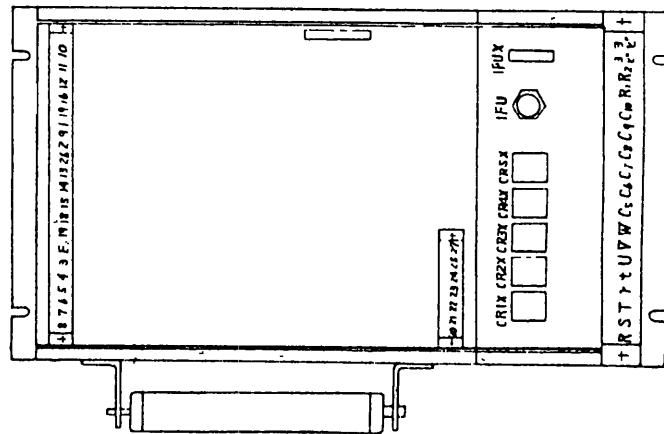

PARTS LAYOUT OF HEAT SINK (View Arrow A)

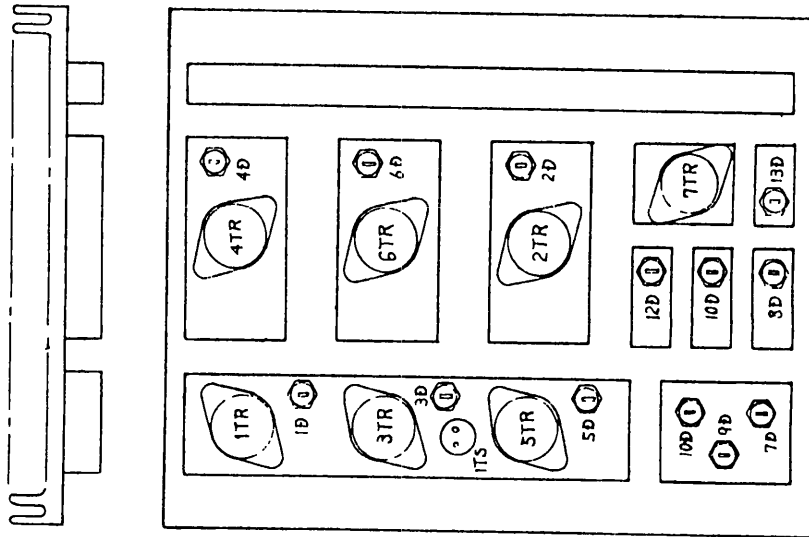

PARTS ARRANGEMENT OF CPCR-QR

1 PWB CPR- QR-CAL C

POTENTIOMETER, CHECK TERMINAL LAYOUT DRAWING

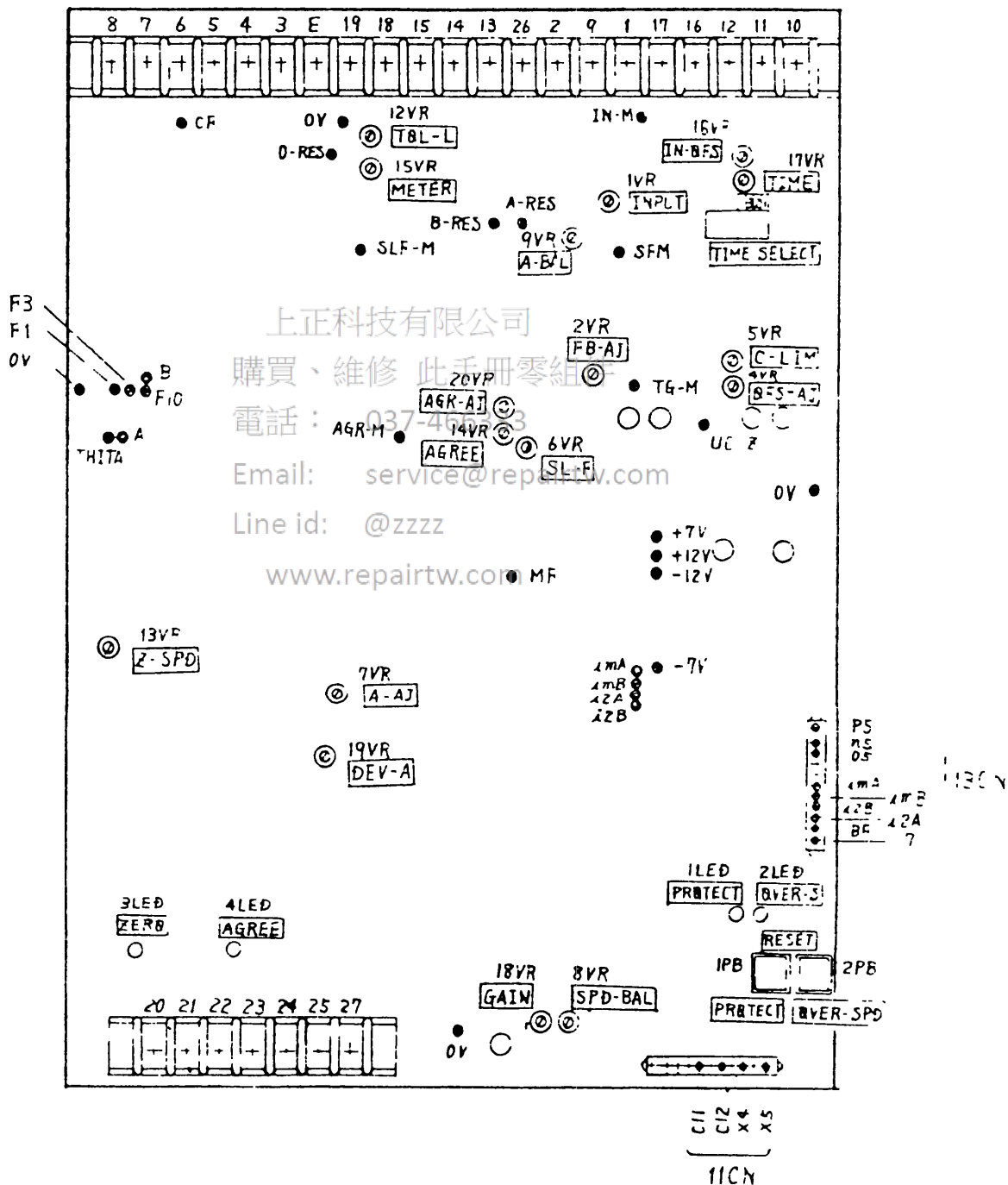

POTENTIOMETER CHECK TERMINAL LAYOUT DRAWING

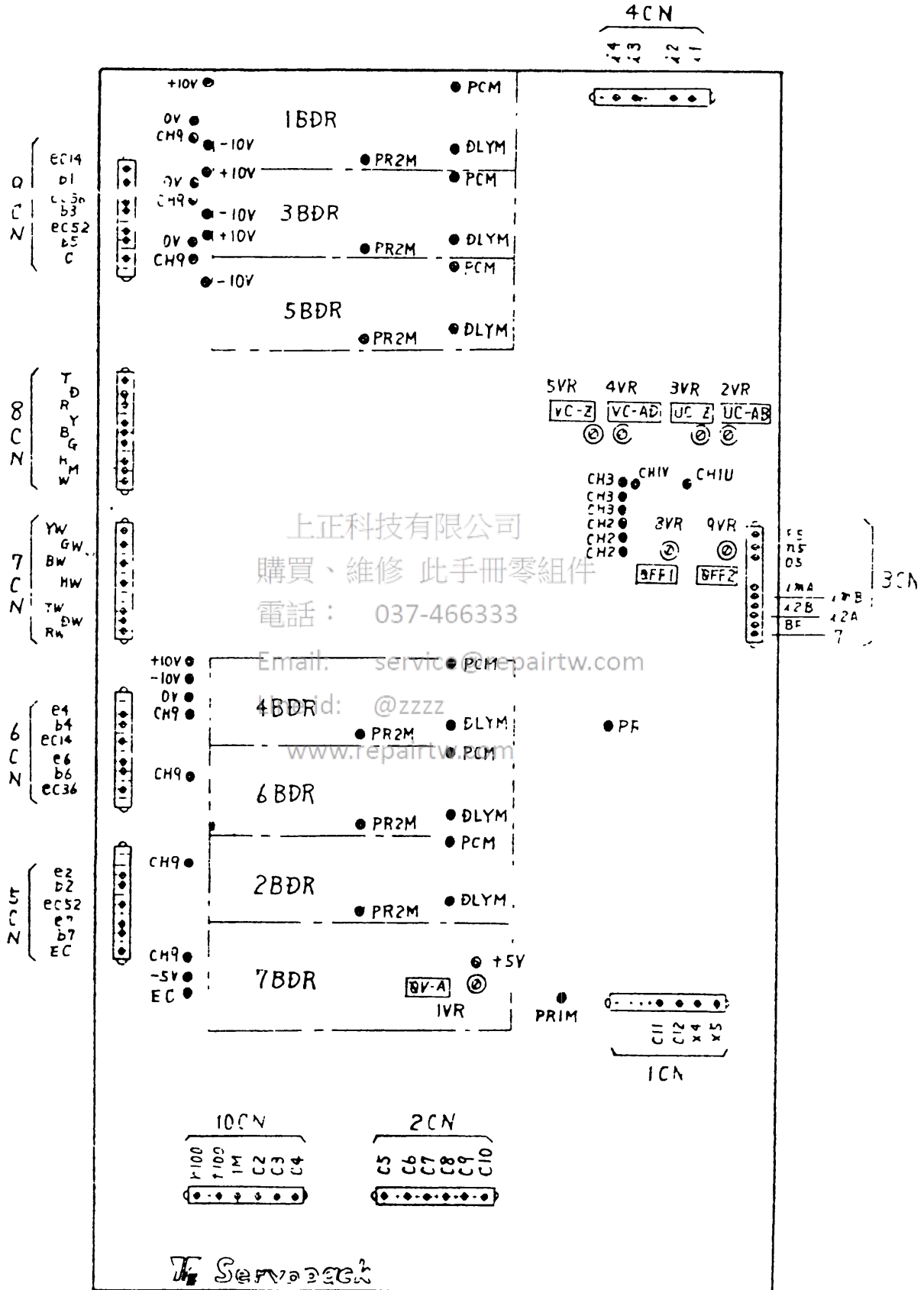

9. MAIN PARTS LIST

Symbol	Name	Ratings and specifications	Maker
1M	Magnetic contactor	HI-12E/1B2, 200VAC	Yaskawa Electric Mfg. Co., Ltd.
1FU	Fuse	BLA03 (C-30), 30A	Fuji Electric Co., Ltd.
1FUX	Alarm fuse	P430, 3A	Daito Communication Apparatus Co., Ltd.
1THS	Thermo-switch	US-118XN, 80 to 90°C	Asahi Keiki Co., Ltd.
2THS	Thermo-switch	US-118XN, 140 to 150°C	Asahi Keiki Co., Ltd.
1Tr-6Tr	Darlington transistors	2SD466, 450V, 50A, hFE100	Saundengen Electric Mfg. Co., Ltd.
7Tr	Darlington transistors	2SD915, 450V, 30A, hFE100	Fuji Electric Co., Ltd.
1D-6D	Fast recovery diodes	30JG11, 600V, 30A	Tokyo Shibaura Electric Co., Ltd.
7D-12D	Diodes	10M80, 800V, 40A	International Rectifier Corporation, Japan, Ltd.
13D	Diode	6M80, 800V, 15A	International Rectifier Corporation, Japan, Ltd.
1C	Capacitor	CW450LGSN, 450V, 1500 μ X2P	Nippon Chemical Condenser Co., Ltd.
5R, 6R	Resistors	QRY60, 60W, 0.02 ohm	Japan Resistor Mfg. Co., Ltd.
1FAN, 2FAN	Fans	HS4556, 200VAC	Tobishi kosan Co., Ltd.
CR1X-CR5X	Relays	NY-4N, 100VAC	Omron Tateishi Electronics Co.