

Varispeed-626VM3C DRIVE INSTRUCTION MANUAL

INVERTER DRIVES WITH DIGITAL VECTOR-CONTROL

0.4/0.2 TO 5.5/3.7kW

Upon receipt of the product and prior to initial operation, read these instructions thoroughly, and retain for future reference.

上正科技有限公司
購買、維修 此手冊零組件
電話： 037-466333
Email: service@repairtw.com
Line id: @zzzz
www.repairtw.com



YASKAWA

MANUAL NO. TOE-S626-5B

PREFACE

This instruction manual describes precautions and how to handle for proper and safe use of high-performance AC drive systems employing the YASKAWA vector control inverter. Read this manual thoroughly before operation.

This manual explains operation examples under typical conditions. For applications under special conditions, contact your YASKAWA representative. Users are requested to use the equipment within the range of the specifications and in the manner described in this manual.

YASKAWA ELECTRIC CORPORATION

General Precautions

- Some drawings or photos in this manual are shown with the protective cover or shields removed, in order to describe detail with more clarity. Make sure all covers and shields are replaced before operating this product.
- This manual may be modified when necessary because of improvement of the product, modification, or changes in specifications. Such modifications are denoted by a revised manual No.
- To order a copy of this manual, if your copy has been damaged or lost, contact your YASKAWA representative.
- YASKAWA is not responsible for any modification of the product made by the user, since that will void your guarantee.

NOTES FOR SAFE OPERATION

Read this manual thoroughly before installation, operation, maintenance or inspection of the VS-626VM3C. In this manual, NOTES FOR SAFE OPERATION are classified as “WARNING” or “CAUTION”.

 **WARNING**

Indicates a potentially hazardous situation which, if not avoided, could result in death or serious injury to personnel.



 **CAUTION**



Indicates a potentially hazardous situation which, if not avoided, may result in minor or moderate injury to personnel and damage to equipment.

It may also be used to alert against unsafe practices.

Even items described in  **CAUTION** may result in a vital accident in some situations. In either case, follow these important notes.

 **NOTE** : These are steps to be taken to insure proper operation.

This manual also contains precautions for safe use of the equipment. Pay special attention to precautions marked with , , and .

-  : Precautions to prevent accidents that may lead to injury.
-  : Precautions to prevent accidents that may lead to failure of damage to the equipment.
-  : Precautions about installation or wiring conditions to prevent accidents that may lead to failure or damage to the equipment.

上正科技有限公司
購買·維修·此手冊零組件
電話：037-466333
Email: service@repairtw.com
Line id: @zzzz
www.repairtw.com

RECEIVING

 CAUTION
(Ref. page)
• Do not install or operate any inverter which is damaged or has missing parts. Failure to observe this caution may result in personal injury or equipment damage.3

INSTALLATION AND WIRING



WARNING

(Ref. page)

- Only commence wiring after verifying that the power supply is turned OFF.
Failure to observe this warning can result in an electrical shock or a fire.18
- Wiring should be performed only by qualified personnel.
Failure to observe this warning can result in an electrical shock or a fire.
- When wiring the emergency stop circuit, check the wiring thoroughly before operation.
Failure to observe this warning can result in personal injury.18
- Make sure to ground the ground terminal \oplus .
(Ground resistance...200V class: 100 Ω or less)
Failure to observe warning can result in an electrical shock or a fire.18



CAUTION

(Ref. page)

- Lift the cabinet by the base. When moving the unit, never lift by the front cover.
Otherwise, the main unit may be dropped causing damage to the unit. 9
- Mount the inverter on nonflammable material (i.e.metal).
Failure to observe this caution can result in a fire. 9
- For open chassis type, install a fan or other cooling device to keep the intake air temperature below 45°C.
Overheating may cause a fire or damage to the unit. 9
- Verify that the inverter rated voltage coincides with the AC power supply voltage.
Failure to observe this caution can result in personal injury or a fire.
- Do not perform a withstand voltage test of the inverter.
It may cause semi-conductor elements to be damaged.18
- To connect a braking resistor, braking resistor unit or braking unit, follow the procedures described in par.5.
Failure to observe this caution can result in a fire.18
- Make sure to tighten terminal screws.
Failure to observe this caution can result in erroneous operation, machine damage or a fire.18
- Never connect the AC main circuit power supply to output terminals U, V and W.
The inverter will be damaged and invalidate the guarantee.18

OPERATION OF DIGITAL OPERATOR



WARNING

(Ref. page)

- Since the stop button of the digital operator can be disabled by a function setting, install a separate emergency stop switch.

Failure to observe this warning can result in personal injury.55

TEST RUN



WARNING

(Ref. page)

- Only turn ON the input power supply after replacing the front cover. Do not remove the covers while current is flowing.

Failure to observe this warning can result in an electrical shock.79

- Never operate the digital operator or the switches when your hand is wet.

Failure to observe this warning can result in an electrical shock.79

- Never touch the terminals while current is flowing, even during stopping.

Failure to observe this warning can result in an electrical shock.79

購買、維修 此手冊零組件

電話： 037-466333

Email: service@repairtw.com

Line id: @zzzz

www.repairtw.com



CAUTION

(Ref. page)

- Never touch the heatsink or discharging resistor since the temperature is very high.
Failure to observe this caution can result in harmful burns to the body.79
- Since it is easy to change operation speed from low to high speed, verify the safe working range of the motor and machine before operation.
Failure to observe this caution can result in personal injury and machine damage. ... 79
- Install a holding brake separately if necessary.
Failure to observe this caution can result in personal injury.79
- Do not change signals during operation.
The machine or the inverter may be damaged. 79
- All the constants of the inverter have been preset at the factory. Do not change the settings unnecessarily.
The inverter may be damaged. For common terminal pins of sequence input signals, change the pins according to input method in par.4.1.79

MAINTENANCE AND INSPECTION



WARNING

(Ref. page)

- Never touch high-voltage terminals in the inverter.
Failure to observe this warning can result in an electrical shock.93
- Perform maintenance or inspection only after verifying that the CHARGE LED goes OFF, after the main circuit power supply is turned OFF.
The capacitors are still charged and can be dangerous. 93
- Only authorized personnel should be permitted to perform maintenance, inspections or parts replacement.
[Remove all metal objects (watches, bracelets, etc.) before operation.]
(Use tools which are insulated against electrical shock.)
Failure to observe this warning can result in an electrical shock. 93



CAUTION

(Ref. page)

- The control PC board employs CMOS ICs. Do not touch the CMOS elements.
The inverter may be damaged by static electricity. 93
- Do not connect or disconnect wires or connectors while power is applied to the circuit.
Failure to observe this caution can result in an electrical shock, personal injury or equipment damage. 93

OTHERS

WARNING

(Ref. page)

- Never modify the product.

Failure to observe this warning can result in an electrical shock or personal injury and will invalidate the guarantee.

A warning label is displayed on the front cover of the inverter, as shown below. Follow these instructions when handling the inverter.

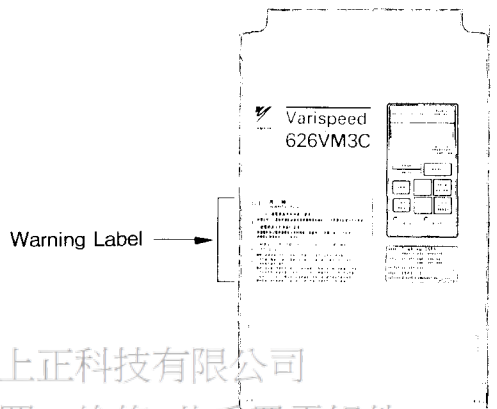

上正科技有限公司
購買、維修 此手冊零組件
電話： 037-466333
Email: service@repairtw.com
Line id: @zzzz
www.repairtw.com

Warning Label

 **危 險**
WARNING

けが、感電のおそれがあります。

- 据え付け、運転の前には必ず取扱説明書を読んで、その指示に従ってください。

感電のおそれがあります。

- 通電中及び電源遮断後 1 分以内は、表面カバーを開けないでください。
- 確実に接地を行ってください。

May cause injury or electric shock.

- Please follow the instructions in the manual before installation or operation.
- Disconnect all power before opening front cover of unit. Wait 1 minute until DC Bus capacitors discharge.
- Use proper grounding techniques.

上正科技有限公司
購買、維修 此手冊零組件
電話： 037-466333
Email: service@repairtw.com
Line id: @zzzz
www.repairtw.com

CONTENTS

1. STANDARD SPECIFICATIONS

1

2. RECEIVING INSPECTION AND PRE-STORAGE CHECK

2

3. MOUNTING AND WIRING

3

4. CONTROL SIGNALS

4

5. ORIENTATION CONTROL

5

6. PREPARATION BEFORE STARTING

6

7. OPERATION OF DIGITAL OPERATOR

7

8. TEST RUN

8

9. MAINTENANCE

9

10. TROUBLESHOOTING

10

11. SPARE PARTS

11

CONTENTS

1. STANDARD SPECIFICATIONS	1
2. RECEIVING INSPECTION AND PRE-STORAGE CHECK.....	3
2.1 CHECK WHEN UNPACKING	3
2.1.1 Inverter Nameplate	4
2.2 NOTES ON STORAGE.....	5
3. MOUNTING AND WIRING	7
3.1 NOTES ON INSTALLATION OF THE MOTOR.....	7
3.1.1 Installation Location.....	7
3.1.2 Installation Orientation	7
3.1.3 Connection to Load Machine	8
3.2 NOTES ON INSTALLATION OF THE INVERTER	9
3.2.1 Installation Location.....	9
3.2.2 Exterior and Mounting Dimensions.....	11
3.2.3 Installation Orientation.....	11
3.3 CONNECTION	12
3.4 WIRING SPECIFICATIONS	13
3.4.1 Power Cables and Terminals	13
3.4.2 Control Signal Lines	14
3.4.3 Control Signal Connectors Terminal Layout.....	15
3.5 STANDARD WIRING DIAGRAM	16
3.5.1 When Using Braking Resistor Unit	16
3.5.2 When Using Braking Unit and Braking Resistor Unit	17
3.6 NOTES ON CONNECTION	18
4. CONTROL SIGNALS	21
4.1 SEQUENCE INPUT SIGNALS	21
4.2 SPEED REFERENCE	27
4.3 SEQUENCE OUTPUT SIGNALS.....	28
4.4 ENCODER PULSE OUTPUT CIRCUIT.....	31
4.5 ANALOG MONITOR SIGNALS	32
5. ORIENTATION CONTROL	33
5.1 ENCODER TYPE ARBITRARY POSITION ORIENTATION CONTROL.....	33

5.1.1	Arbitrary Position Stop Control by Load Axis Encoder	34
5.1.2	Home Position Stop Control by Motor Encoder	36
5.1.3	Specifications of Orientation Control	37
5.1.4	Dimensions in mm (in inches)	39
5.1.5	Connections	40
5.1.6	Control Signal Connectors Terminal Layout	41
5.1.7	Notes on Installing and Wiring of Encoder	42
5.1.8	Stop Position Reference Input Signals	43
5.2	HOME POSITION ORIENTATION CONTROL BY MAGNETIC SENSOR	44
5.2.1	Stop at Home Position by Magnetic Sensor	45
5.2.2	Orientation Specifications	46
5.2.3	Dimensions in mm (in inches)	47
5.2.4	Connection	49
5.2.5	Control Signal Connector Terminal Layout	50
5.2.6	Installing Magneto and Magnetic Sensor	50
5.2.7	Notes on Mounting	51
6.	PREPARATION BEFORE STARTING	53
6.1	CHECK BEFORE TURNING ON POWER	53
6.2	CHECKING POWER VOLTAGE	53
7.	OPERATION OF DIGITAL OPERATOR	55
7.1	FUNCTIONS OF THE DIGITAL OPERATOR	55
7.2	KEY OPERATIONS AND DISPLAY	57
7.2.1	Indication at Power-ON	58
7.2.2	Switching Display Functions	58
7.2.3	Operation Status Display Mode	59
7.2.4	Control Constant Display Mode	60
7.2.5	Digital Operator Operation Mode	61
7.2.6	Protective Function Operation Display Mode	62
7.3	OPERATION STATUS DISPLAY FUNCTION	63
7.4	CONTROL CONSTANT	66
7.5	PROTECTIVE FUNCTION DISPLAY	76

8. TEST RUN	79
8.1 CHECK AFTER TURNING ON POWER	79
8.1.1 Checking the Motor	79
8.1.2 Checking the Inverter	79
8.1.3 Checking Status Display	79
8.2 SETTING UP CONSTANTS	81
8.2.1 Soft Start Time Setup	81
8.2.2 Load Meter Full-scale	81
8.2.3 Zero-speed Detection Level	81
8.2.4 Speed Agreed Width	82
8.2.5 Speed Detection Level	82
8.2.6 External Operation Torque Limiting Level	83
8.2.7 Motor Code Selection	83
8.2.8 Rated Speed	83
8.2.9 Transmission Ratio	83
8.2.10 Flux and Base Speed Ratio in Servo Mode	84
8.2.11 Positioning Completion Detection Width	84
Positioning Completion Cancel Width	84
8.2.12 Orientation Speed	85
8.2.13 Resolution of BCD Stop Position Instructions	86
8.3 OPERATION	86
8.4 ADJUSTMENT PROCEDURE AND CONTROL CONSTANT SETUP	87
8.4.1 Adjustment in Speed Control Mode	87
8.4.2 Adjustment in Encoder Orientation Control Mode	89
8.4.3 Adjustment in Magnetic Sensor Orientation Control Mode	91
9. MAINTENANCE	93
9.1 DAILY CHECK LIST	93
9.2 PERIODICAL MAINTENANCE	94
9.3 PERIODICAL CHECK LIST AND ACTION TO BE TAKEN	95
9.4 INSULATION RESISTANCE TEST (INVERTER)	96
10. TROUBLESHOOTING	97
11. SPARE PARTS	115

1 STANDARD SPECIFICATIONS

Table 1.1 Standard Specifications

Model CIMR-VMC		20P4	20P7	21P5	22P2	23P7	25P5
Max. Applicable Motor Output	HP (kW)	0.5 (0.4)	1 (0.75)	2 (1.5)	3 (2.2)	5 (3.7)	7.5 (5.5)
Input Voltage		200, 220V (50/60Hz), 230V (60Hz)					
Allowable Voltage Fluctuation		+10%, -15%					
Allowable Frequency Variation		±5%					
Required Power Capacity		1kVA	1.5kVA	3kVA	4kVA	7kVA	9kVA
Speed Control Range		1 : 200					
Rated Output Control Range		1 : 2 to 1 : 8					
Overload Capacity		120%/60s of 15-minute rating					
Control Method	Speed	Speed control by motor encoder signal					
	Torque	Vector control with magnetic control					
Braking Method		Braking resistor (provided separately)					
Speed Regulation		0.2% maximum speed or below (load variation : 10 to 100%)					
Speed Command		Analog ±10V/100%					
Soft Start Time		0.1 to 180.0sec					
Protective Function		Overcurrent, overload, overvoltage, overspeed power fault, excessive speed deviation, motor overheat, encoder signal disconnection					
Contact Input Signal		Emergency stop, operation ready, forward/reverse run, gear selection, soft start, torque limit, fault reset, orientation					
Contact Output Signal		Zero-speed, speed agree, speed detection, fault during torque limit, orientation					
Encoder Signal Output		1024PPR (A, B Phase) 1PPR (C Phase) differential output					
Monitor Output		Speedometer signal, load meter signal (analog, +10V)					
Constant Setting		Digital operator (JOVP-100)					
Ambient Temperature		0 to +55°C (not frozen)					
Storage Temperature*		-20 to +60°C					
Humidity		5 to 90%RH (non-condensing)					
Vibration		1G at less than 20Hz, 0.2G at 20 to 55Hz					
Location		Indoor (protected from corrosive gases and dust), less than 1000m (elevation)					

* Temperature during transportation (for short periods)

上正科技(上海)有限公司

上海青浦區崑崙崑山街100號

電話：021-59111111

傳真：021-59111111

郵政信箱：100000

郵政編碼：201315

郵政地址：上海

郵政地址：上海

郵政地址：上海

郵政地址：上海

上正科技有限公司

購買、維修 此手冊零組件

電話： 037-466333

Email: service@repairtw.com

Line id: @zzzz

www.repairtw.com

2. RECEIVING INSPECTION AND PRE-STORAGE CHECK

2.1 CHECK WHEN UNPACKING

Upon receipt of the inverter VS-626VM3C Drives, unpack and check the following. Make sure that the inverter is kept free from packing materials or fittings.

- (1) Check the type and specifications of the delivered product with the shipping documents.
- (2) Check optional equipment and spare parts.
- (3) Verify that a parameter list is provided.
- (4) Check for any damage during transportation.

If there is any discrepancy or any condition such as damage, or the delivered equipment does not conform to listed specifications, contact your YASKAWA representative. Phone and fax numbers of YASKAWA representatives are listed on the back cover of this manual.

上正科技有限公司
購買、維修 此手冊零組件
電話： 037-466333
Email: service@repairtw.com
Line id: @zzzz
www.repairtw.com

2.1.1 Inverter Nameplate

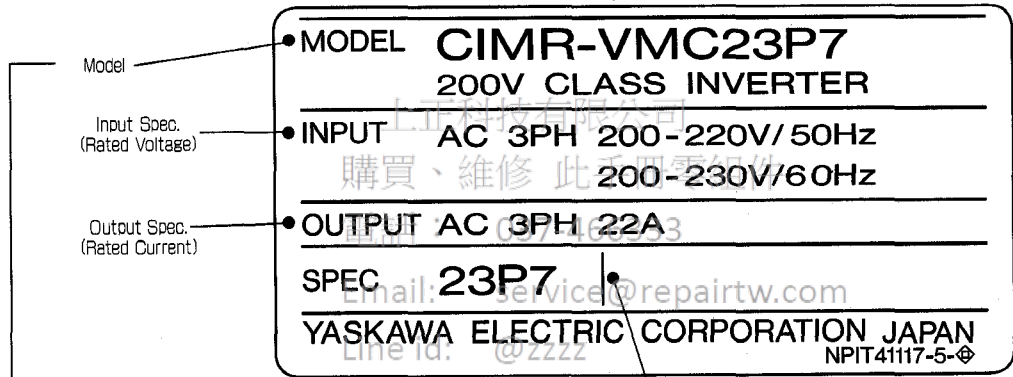
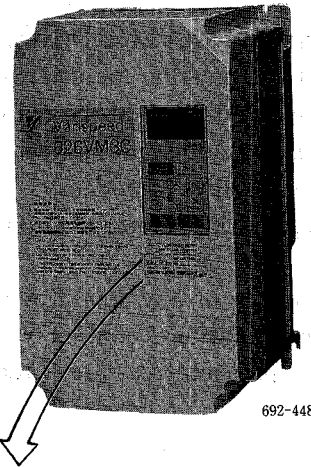

Option Display of Spec. No.

INVERTER MODEL DESIGNATION

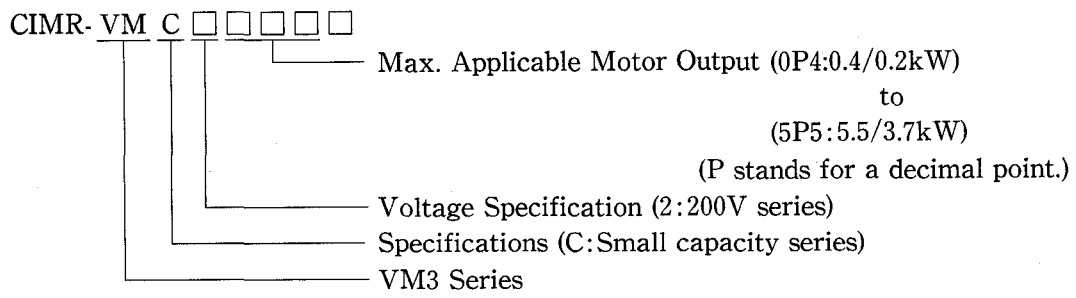

Fig. 2.1 Example of Inverter Nameplate

2.2 NOTES ON STORAGE

If the inverter is to be stored for a period of time, prepare the following conditions to keep the equipment in good order.

(1) Temperature: 0°C to +60°C

(2) Humidity: 5% to 90% (RH) (Non-condensing)

—★— Air containing 50% RH at +40°C condenses when cooled to +28°C. Take special care if extreme temperature fluctuations exist/occur in the storage area.

(3) Location: Indoors free from corrosive gases and dust

2

上正科技有限公司
購買、維修 此手冊零組件
電話： 037-466333
Email: service@repairtw.com
Line id: @zzzz
www.repairtw.com

上正科技股份有限公司

本公司提供各項維修服務，包括零件更換、系統升級、數據恢復等。

歡迎垂詢，我們將竭誠為您服務。

地址：台北市中正區... (faint text)

電話：037-466333

Email: service@repairtw.com

Line id: @zzzz

www.repairtw.com

上正科技有限公司

購買、維修 此手冊零組件

電話： 037-466333

Email: service@repairtw.com

Line id: @zzzz

www.repairtw.com

3. MOUNTING AND WIRING

3.1 NOTES ON INSTALLATION OF THE MOTOR



The flange surface and the output shaft of the motor are coated with rust preventives or grease. Clean the flange surface, output shaft, and keyways with thinner before installation.

3

3.1.1 Installation Location

(1) When the motor with cooling fan is applied, make sure that enough cooling air is supplied to the cooling fan. The motor opposite drive end (where cooling air is exhausted from) must be separated from nearby equipment by 100 millimeters or more.

—★— If supplied air is insufficient, motor thermal fault protection may be activated even if the load is within the rating.

(2) The motor must be protected from water or oil splashes.

—★— Entry of water or oil into the motor may deteriorate insulation and cause a ground fault.

(3) The motor must be mounted on a sturdy bed, base, or frame.

—★— Adding to the motor weight, dynamic load is applied to the bed during operation, and vibration may occur.

3.1.2 Installation Orientation

(1) Flange-mounted type motors can be mounted when the motor output shaft is connected to the load machine in a horizontal to vertically-downward position.

—★— If the output shaft is directed upward, excess force is applied to the motor bearing and the life may be shortened.

(2) Foot-mounted motors must be mounted on the floor with the foot down.

—★— If the motor is hung upside down, excess force is applied to the foot and its life may be shortened.

3.1.3 Connection to Load Machine

(1) To connect directly, align the centers of the motor shaft and load machine shaft, so that the two shafts form a straight line. Use a spline if necessary.

- ★- If the centers of the shafts are misaligned, excessive twisting force is applied to both the motor shaft and load machine shaft, and the bearing may be damaged or worn out quickly.

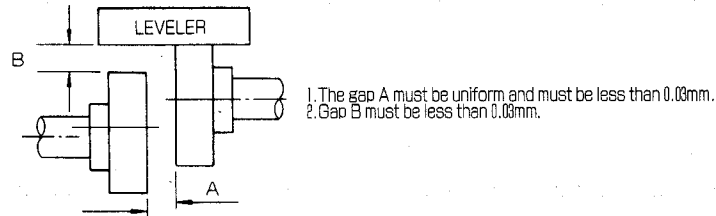

Fig. 3.1 Connection between the Motor and Load Machine

(2) For V-belt drive, lay the motor and spindle parallel to each other, and perpendicular to the line passing through the centers of both pulleys. Radial load applied to the shaft end of the motor output flange must not exceed the limit.

- ★- If the belt is not placed at an exact right angle, vibration may occur or the belt may slip. If an excess radial load is applied to the motor shaft, excess force is applied to the motor bearing and its life may be shortened.

(3) The arc of contact (ϕ) must be 140° or greater.

- ★- If the arc of contact (ϕ) is smaller, the belt may slip.

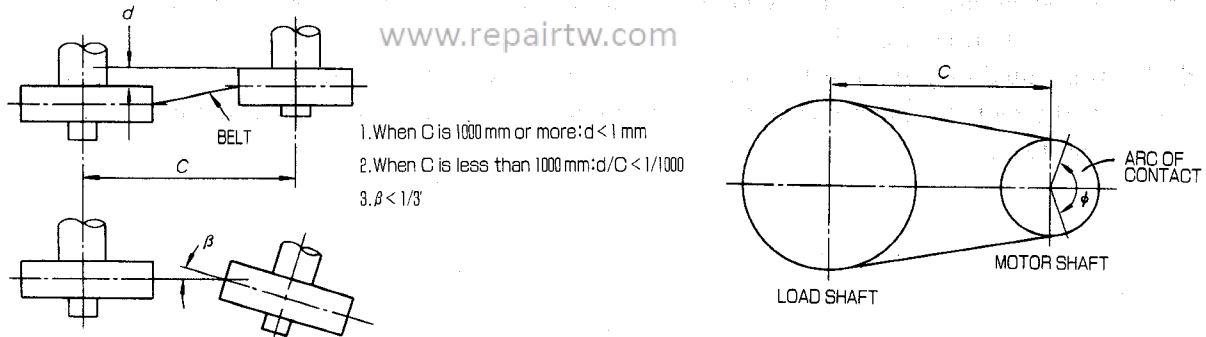

Fig. 3.2 Connecting a Belt

(4) To use gears, lay the motor and machine shafts parallel to each other, and engage the shafts at the centers of the tooth surfaces.

- ★- If the tooth surfaces are not engaged properly, gear noise occurs.

(5) To attach pulleys or gears to the motor output flange, they must be balanced well. The motor is in dynamic balance when a half-key having a half-thickness of the size shown in the dimension diagram (of the shaft) is attached.

- ★- A slight unbalance may cause vibration during high-speed rotation.

3.2 NOTES ON INSTALLATION OF THE INVERTER



When carrying the inverter, handle with care so as not to damage it. Holding the face plate or PC board frame when carrying may damage the equipment.

3.2.1 Installation Location

- (1) The inverter must be kept free from water or oil splashes.
 - ★— Entry of water or oil into the inverter may deteriorate insulation and cause a ground fault.
- (2) Avoid direct sunlight.
 - ★— Radiant heat of the sun may raise the temperature in the inverter over the operating thermal range and life of electronic components may be significantly reduced.
- (3) Avoid corrosive gases and liquids. Avoid locations where dust or iron powder is abundant.
 - ★— Corrosion by harmful gases or adhesion of dust may deteriorate insulation resistance and cause a ground fault.
- (4) The inverter houses the heat sink cooling fan at the rear. Leave 150 mm or greater clearance on the upper (exhaust) and lower (entry) sides of the fan to prevent cooling performance deterioration.
 - ★— If air flow is obstructed and insufficient cooling air is supplied, a heat sink overheat error may occur even when the output is within the rating.
- (5) Although the control panel open-chassis type inverter is operable at 0°C to +55°C, air entering the heat sink must be 45°C or below. See Fig. 3.3.
 - ★— If warmer air is input, heat dissipation from the heat sink is reduced and a heat sink overheat error may occur even when the output is within the rating.
- (6) For ease of periodical inspection and maintenance, leave space to open and close the PC board frame. Also make clearance of 30 mm or greater from each side panel of the inverter.
 - ★— If the above clearances are not provided, proper inspection and maintenance will not be possible.

- (7) Place sealant at the unit mounting joint to prevent entry of dust.
- ★— If no sealant is applied, water or iron powder may enter from the joint to deteriorate insulation and cause a ground fault.

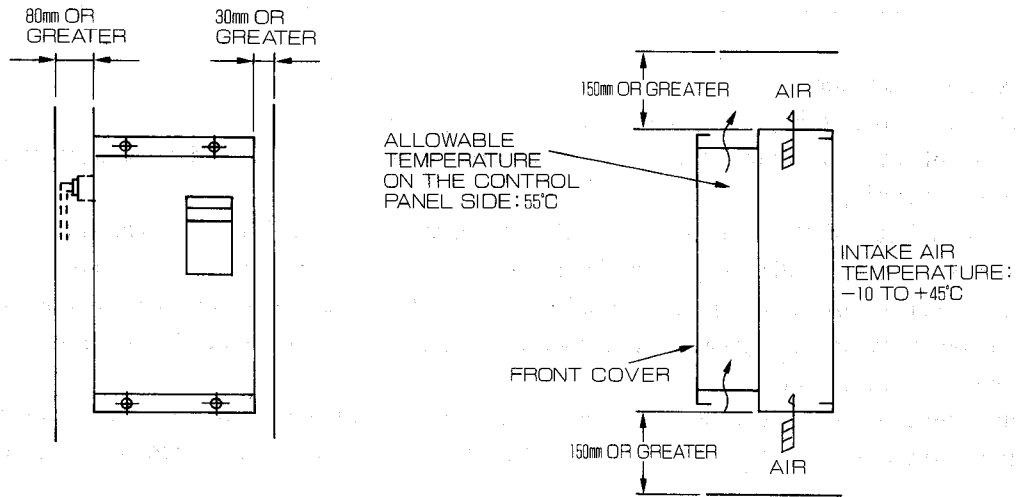

(a) Clearance on the left and right sides (b) Clearance above and below

Fig. 3.3 Inverter Installation Space

電話： 037-466333

Email: service@repairtw.com

Line id: @zzzz

www.repairtw.com

3.2.2 Exterior and Mounting Dimensions

Table 3.1 shows the exterior and mounting dimensions for VS-626VM3C drives.

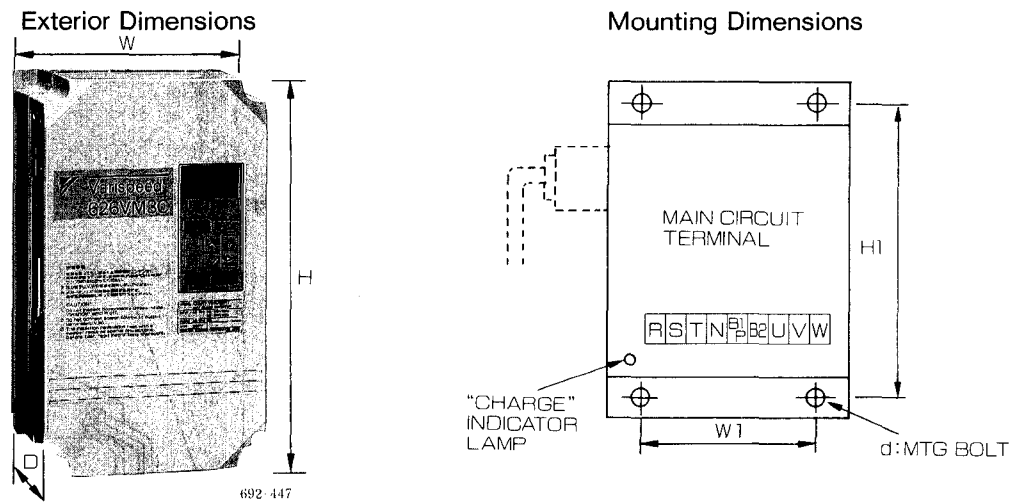

Table 3.1 Exterior and Mounting Dimensions

Voltage Class	Model CIMR-VMC□□	Capacity kVA	Exterior Dimensions in mm (inches)			Mounting Dimensions in mm (inches)			Approx Mass kg (lb)
			W	H	D	W ₁	H ₁	d	
200V	20P4	1	204.5 (8.35)	304 (12.4)	190 (7.76)	180 (7.35)	285 (11.6)	M6	5 (11.02)
	20P7	1.5	204.5 (8.35)	304 (12.4)	225 (8.86)	180 (7.35)	285 (11.6)	M6	7 (15.43)
	21P5	3	204.5 (8.35)	304 (12.4)	255 (10.0)	180 (7.35)	335 (13.2)	M6	10 (22.05)
	22P2	5	204.5 (8.35)	354 (13.9)	255 (10.0)	180 (7.35)	335 (13.2)	M6	10 (22.05)
	23P7	7.5	204.5 (8.35)	354 (13.9)	255 (10.0)	180 (7.35)	335 (13.2)	M6	10 (22.05)
	25P5	10	204.5 (8.35)	354 (13.9)	255 (10.0)	180 (7.35)	335 (13.2)	M6	10 (22.05)

3.2.3 Installation Orientation

For cooling efficiency and ease of maintenance, the inverter must be installed in a vertical position with the input-output terminals below.

- ★— If the inverter is placed in a horizontal position, the inverter inside temperature exceeds the operating thermal range even when the output is within the rating, and the life of the electronic components may be significantly reduced.



Do not drill or weld the control panel after mounting the inverter. Otherwise, metal chips may be left in the inverter and lead to a failure.

3.3 CONNECTION

Fig. 3.4 shows equipment configuration for a drive system. Connect the power source, inverter, and motor properly according to the drive system configuration and connection diagram.

When the drive is to be used for single-motor drive and no system connection diagram is found, refer to Fig.3.4.

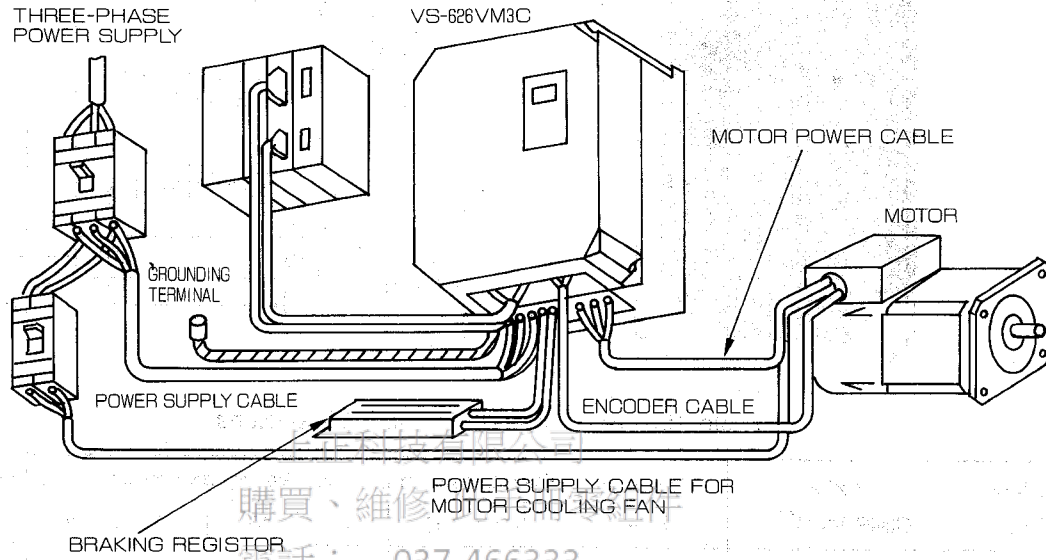

Fig. 3.4 Configuration for Single-Motor Drive System

Email: service@repairtw.com

Line id: @zzzz

www.repairtw.com

3.4 WIRING SPECIFICATIONS

Take the following into account when selecting the inverter power cables, motor cooling fan power cables, and control signal lines.

3.4.1 Power Cables and Terminals

Table 3.2 lists the rated current, types and size of cables, and terminal size of the inverters. Layout of the motor terminal box is shown in Fig. 3.5 (Connector Terminal Layout). Layout of input and output terminals of the inverters is shown in Par.3.2.2, “Exterior and Mounting Dimensions”.

Table 3.2 Power Cable Specifications

Inverter Model CIMR-VMC	Rated Current (A)	Cable Nominal Cross Section (mm ²)*			Terminal Name and Screw Size		
		600V Vinyl Cable (IV, VV)	600V Flame-resistant Crosslinked Polyethylene Cable	600V Rubber-insulated Cabtyre Cable (CT)	Inverter Terminals		
					Input	Output	
200V	20P4	3	2.0	2.0	2.0	M4	M4
	20P7	5	2.0	2.0	2.0	M4	M4
	21P5	9	2.0	2.0	2.0	M4	M4
	22P2	13	2.0	2.0	2.0	M4	M4
	23P7	22	3.5	2.0	3.5	M5	M5
	25P5	33	5.5	3.5	5.5	M5	M5

Note: Motor terminal screw size is to be M5 for 5.5kW (15-minutes rating) and M4 for 3.7kW or less.

* Cable size is selected assuming external suspended wiring of single 3-core cables at an ambient temperature of 30°C.

Maximum allowable conductor temperature is 60°C for the IV, VV, and CT cables, and 110°C for the 600V flame-resistant crosslinked polyethylene cable.

NOTE

If the ambient temperature is higher than 30°C, allowable current of cables is decreased. Refer to the rated current in Table 3.2 and select appropriate cable size according to JIS standards or the technical data provided by the cable manufacturer. Related JIS standards are as follows:

IV : JIS C 3307

VV : JIS C 3342

CT : JIS C 3302

The flame-resistant crosslinked polyethylene cable shall conform to Japan cable industrial standard JCS No.360.

3.4.2 Control Signal Lines

Table 3.3 lists types and sizes of control signal connectors and cables. Layout of the motor terminal box is shown in Fig. 3.5 (Connector Terminal Layout). Layout of input and output terminals of the inverters is shown in Par. 3.2.2, "Exterior and Mounting Dimensions".

Table 3.3 Specifications of Control Signal Connectors and Cables

Between NC/PC and Inverter		Between Inverter and Motor		
Cable	Connector (1CN)	Connector (2CN)	Cable	Connector
0.3mm ² concentric 50-core or 600V vinyl sheathed cable (IV) (0.5mm ²)* or complex KQVV-SW AWG 22×3C AWG 26×6P YASKAWA drawing No. DP 8409123	MR-50LF† (50 pins)	MR-20LF† (20 pins)	Complex KQVV-SW‡ AWG 22×3C AWG 26×6P YASKAWA drawing No. DP 8409123	MLP-12 (12 pins)

* For the 1CN signal line except for the analog signals such as speed instructions, 600V vinyl sheathed cable (IV) can be used. When this cable is used, the signal and power cables must be separated and the cable extension must be as short as possible (20m or less) to reduce noise.

† The diameter of the wire bundle must be less than the connector leading port.

MR-50LF: 16mm dia

MR-20LF: 11mm dia

‡ The signal and power cables between the inverter and the motor must be separated and the cable extension must be as short as possible (20m or less) to reduce noise.



Do not run the signal and power cables in the same duct and bundle them. Malfunction of the equipment may occur.

Email: service@repairtw.com

Line Id: @zzzz

www.repairtw.com

3.4.3 Control Signal Connectors Terminal Layout

Fig. 3.5 shows terminal layout of the control signal connector. Also refer to Fig. 3.6 (Standard Wiring Diagram) when designing interface with NC or PC. For descriptions about control signals, see Par. 4, "CONTROL SIGNALS."

50	49	48	47	46	45	44	43	42	41	40	39	38	37	36	35	34	33
					COM 1	RST	ORT		TLIM (INC)	SSC (SV)	LGR	REV	FWD	RDY	EMG	COM	COM
			32	31	30	29	28	27	26	25	24	23	22	21	20	19	
				ORE	ORG	TLE		ZSPD	AGR	SDET	0V	LM	0V	SM			
18	17	16	15	14	13	12	11	10	9	8	7	6	5	4	3	2	1
SS (0V)	*PBO	PBO	*PAO	PAO	*PCO	PCO	FLTC	FLTNC	FLTNO	0V		0V		0V	SCOM	SS (0V)	+15V

PCB Side Connector : MR-50RMAG

Cable Side Connector : MR-50LF (G)

(a) CONTROLLER 1CN

20	19	18	17	16	15	14
FG	*PB	PB	*PA	PA	*PC	PC
					THSB	THSA
7	6	5	4	3	2	1
	+5V	+5V	+5V	0V	0V	SS (0V)

PCB Side Connector : MR-20RMAG

Cable Side Connector : MR-20LF (G)

(b) CONTROLLER 2CN

- Notes:
1. The terminal layout is a view of the board connector viewed from the engaged part.
 2. In the figures, □ indicates an input signal to the inverter, whereas □ indicates an output signal from the inverter.
 3. Asterisk (*) with the 2CN signal indicates reverse rotation signal.

ENCODER CONNECTOR

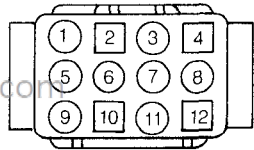
ML Connector (MLR-12)			
			
Sign	Terminal	Sign	Terminal
1	DC +5V	7	PC
2	0V	8	* PC
3	PA	9	FG (Frame Ground)
4	* PA	10	SS (Shielded)
5	PB	11	TS
6	* PB	12	

(When encoder is provided with zero-point signal)

Fig. 3.5 Connector Terminal Layout

3.5 STANDARD WIRING DIAGRAM

3.5.1 When Using Braking Resistor Unit

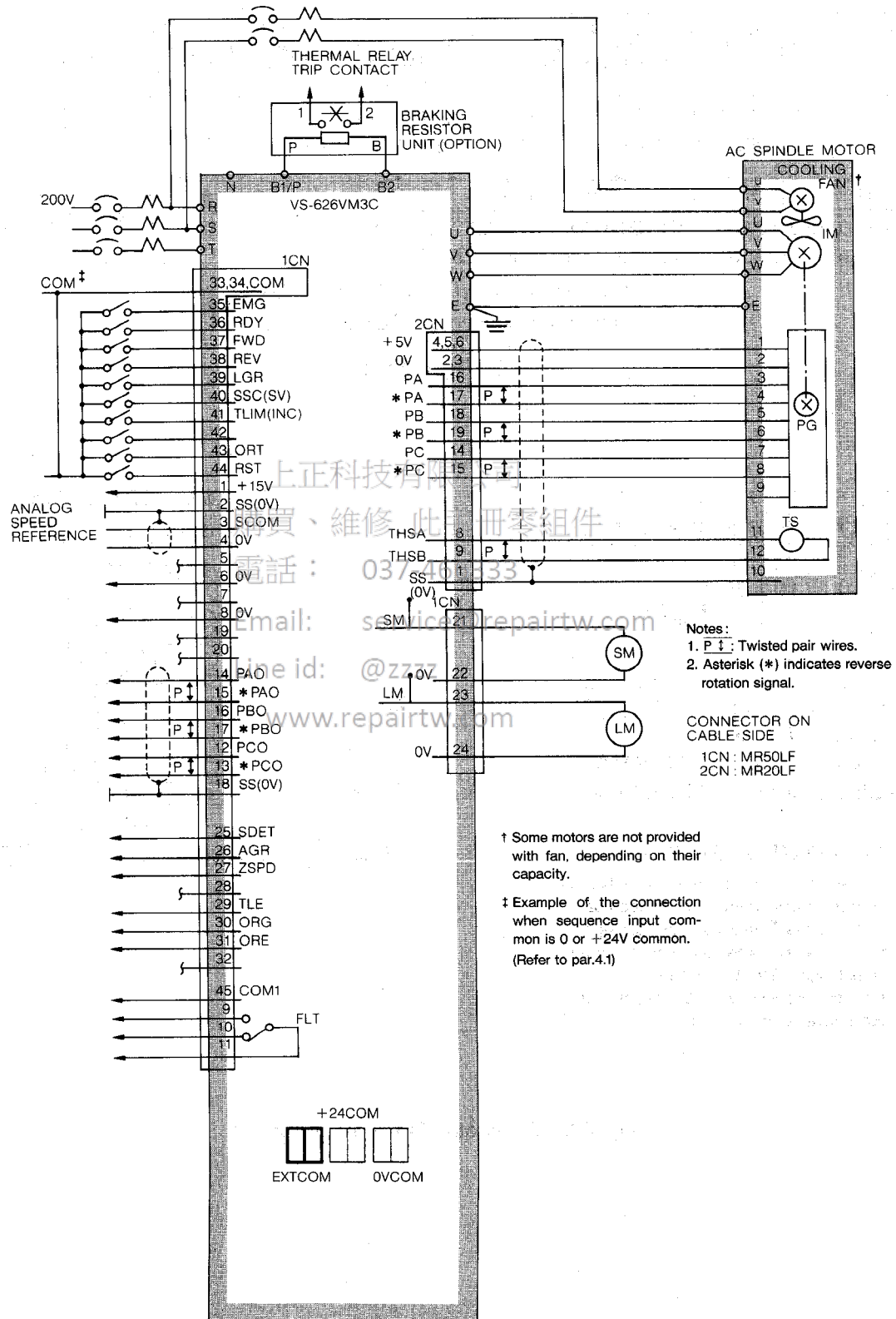

Fig. 3.6 Standard Wiring Diagram

3.5.2 When Using Braking Unit and Braking Resistor Unit

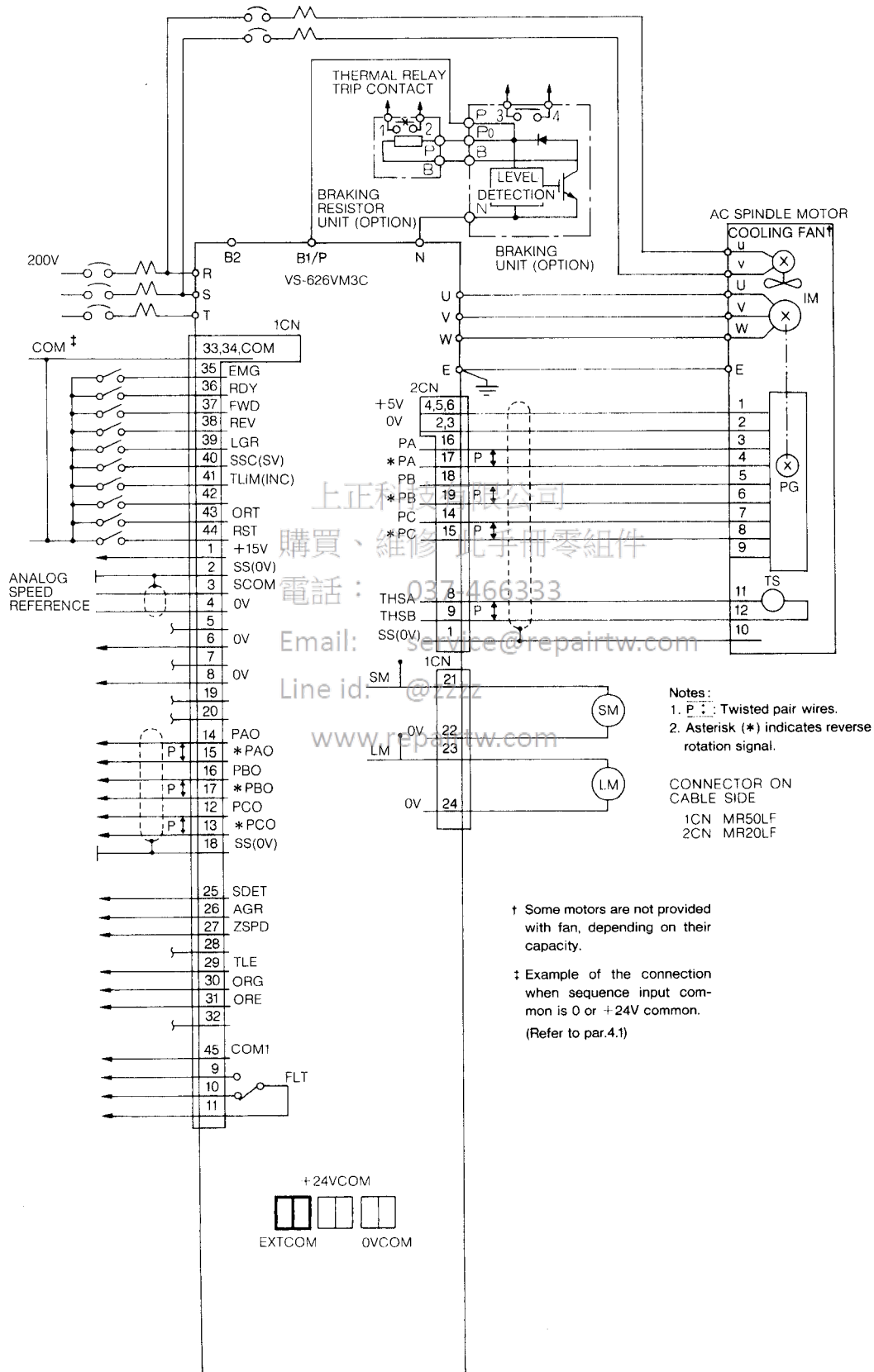

Fig. 3.7 Standard Wiring Diagram

3.6 NOTES ON CONNECTION

Complete interconnections, following the instructions given below.

(1) Control signal leads (1CN and 2CN) must be separated from main circuit leads (R, S, T, U, V, W) and other power lines and power supply lines to prevent erroneous operation caused by noise interference (Electromagnetic interference).

—★— If a signal line (especially the motor encoder signal line) runs along a power cable, the dv/dt noise from the power cable may cause a serious malfunction.

(2) When a twisted shielded wire is used for the control signal line, the terminal must be insulated as shown in Fig. 3.7, except for the motor encoder signal line between the inverter and the motor which must be connected on both ends because the encoder signal line in the motor is a multicore shielded cable. The extension of the control signal line including the encoder signal line must be 20m or less.

—★— A longer motor encoder signal line between the inverter and the motor may result in a voltage drop in the line, reducing encoder power voltage and causing a serious malfunction.

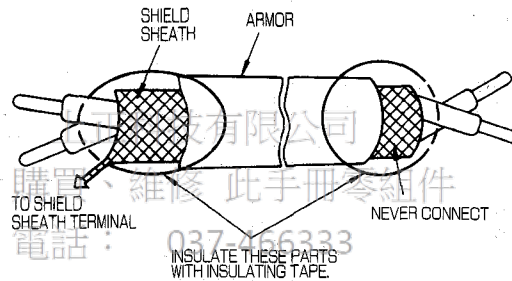

Fig. 3.8 Shielded Lead Termination

(3) Make a positive grounding using ground terminal E on the casing of VS-626VM3C.

- Ground resistance should be 100Ω or less.
- Never ground VS-626VM3C in common with welding machines, motors, and other large-current electrical equipment, or ground pole. Run the ground lead in a separate conduit from leads for large-current electrical equipment.
- Use ground lead listed in technical standards of electric installation and make the length as short as possible.
- Even when VS-626VM3C and motor is grounded through its mountings such as channel base or steel plate, be sure to ground VS-626VM3C using the ground terminal \oplus .
- Where several VS-626VM3C units are used side by side, all the units should preferably be grounded directly to the ground poles. However, connecting all the ground terminals of VS-626VM3C in parallel, and grounding only one of VS-626VM3C to the ground pole is also permissible (Fig. 3.8(a)). However, do not form a loop with the ground leads (Fig. 3.9(b)).

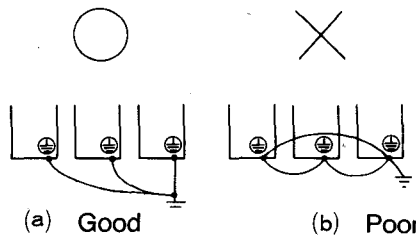

Fig. 3.9 Grounding of Three VS-623VM3C Units

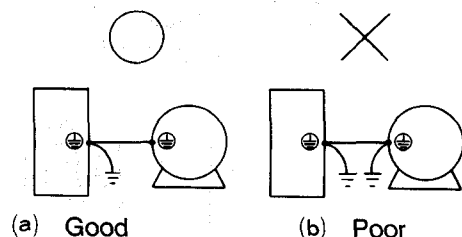

Fig. 3.10 Grounding of Motor and VS-626VM3C

- (4) Phase rotation of input terminals (R, S, T) is available to each direction, clockwise and counterclockwise
- (5) Never connect the power supply to output terminals (U, V, W).
 - ★— If the power supply is connected to an output terminal, excess current flows and internal transistors may be damaged.
- (6) Connect inverter output terminals (U, V, and W) to corresponding motor terminals (U, V, and W).
 - ★— Connection error may cause motor buzzing and vibration, or improper rotation.
- (7) It is possible that failures caused by grounding or short-circuiting of output cables may occur. Be careful not to let cables come in contact with the case.
- (8) Never connect phase advance capacitors between the inverter and the motor. (Fig. 3.10)
 - ★— Inverter output overcurrent protect may be activated or the motor may run away. Phase advancing capacitors may be overheated or damaged by high-frequency component of inverter output voltage.

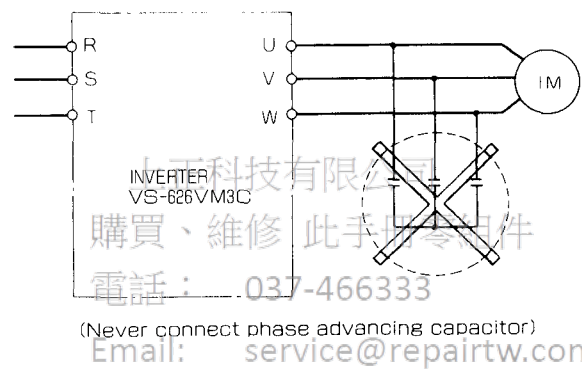

Fig. 3.11 Removal of Phase Advancing Capacitor

(9) When a ground fault interrupter or leak relay is used, it must be well balanced and placed in the power supply line as shown in Fig. 3.11. Since output from the controller contains a high-frequency component, zero-phase current may flow through the voltage-to-ground capacitance of the inverter-motor cable (C1) or the voltage-to-ground capacitance of the motor (C2), improperly activating the ground fault interrupter. To avoid this, observe the following:

- (a) Make the cable between the inverter and the motor as short as possible to reduce steady zero-phase current.
- (b) Set rated sensitivity current high.
- (c) Use a specialized inverter or impulse wave inactive ground fault interrupter.

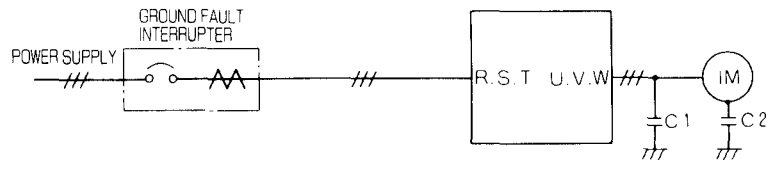

Fig. 3.12 Installation of Ground Fault Interrupter

(10) If both the VS-626VM3C inverter and magnetic contactor are placed in the same control panel, the controller may sometimes operate erroneously due to the noise generated from the coil of the magnetic contactor. Connect a surge suppressor in parallel with the coil of the magnetic contactor. The surge suppressor will absorb the energy stored in the coil of magnetic contactor and thus must have a capacity suited to the coil. YASKAWA's magnetic contactors and surge suppressor are shown in Table. 3.4.

CAUTION

Never connect surge suppressor to the output terminals (U, V, W) of the controller.

—★— If there is no surge absorber, making or breaking of the magnetic contactor generates surge voltage from the winding, disrupting the signal on the inverter control signal line.

Table. 3.4 Application of Surge Suppressor

Magnetic Contactor † and Control Relay Type		Surge Suppressor*		
		Type	Specifications	Code No.
200V Class	Magnetic-contactor HI-10E, -20E, -25E, -35E, -50E, 65E ₂ , -80E ₂ , -125E ₂	DCR2-50A22E	250VAC 0.5μF + 200Ω	C002417
	Control relay RA-6E ₂ , RL-33E			
	Control relay LY-2, -3 [Manufacturer: OMRON Corporation] HH-22, -33 [Manufacturer: FUJI Electric Corporation] MM-2, -4 [Manufacturer: OMRON Corporation]	DCR2-10A25C	250VAC 0.1μF + 200Ω	C002482

* Surge suppressor is made by MARCON ELECTRONICS Co., Ltd.
Use the surge suppressor shown below when any surge suppressor is used other than the above.
200V class : Type DCR2-50A22E

† Magnetic contactors and relays for control are products of YASKAWA CONTROL Co., Ltd.

4 CONTROL SIGNALS

4.1 SEQUENCE INPUT SIGNALS

For input signals, take the following conditions into consideration.

- (1) Possible input methods are 0V common, +24V common, and external common. Select one input by the selection connector on the controller (shown in Fig. 4.1).
- (2) Before changing the selection connector, turn OFF the power.
 - ★- If the selection connector is changed when the control power supply is ON, the control power supply is short-circuited and the PC boards may be damaged.
- (3) Insert the selection connector so as to connect terminals in a column, namely 1 and 2, and 3 and 4.
 - ★- If terminals in a line are connected, the +24V power supply is short-circuited and the PC boards may be damaged.
- (4) When the external common input method is selected, prepare a +24V power supply (20V to 26V) for the input signal.
- (5) When relay contacts, etc. are used, the contact capacity must be 30V or above (5mA or above).
- (6) The filter in the level shifter circuit in the input section causes approximately 5ms delay in the signals.
- (7) Fig. 4.3 shows the input circuit, and Table 4.1 gives the signal functions.
- (8) The ON/OFF status of the input signal can be checked by control signal V1-09. Refer to Fig. 4.2 for the display. See Par.7 for operation.

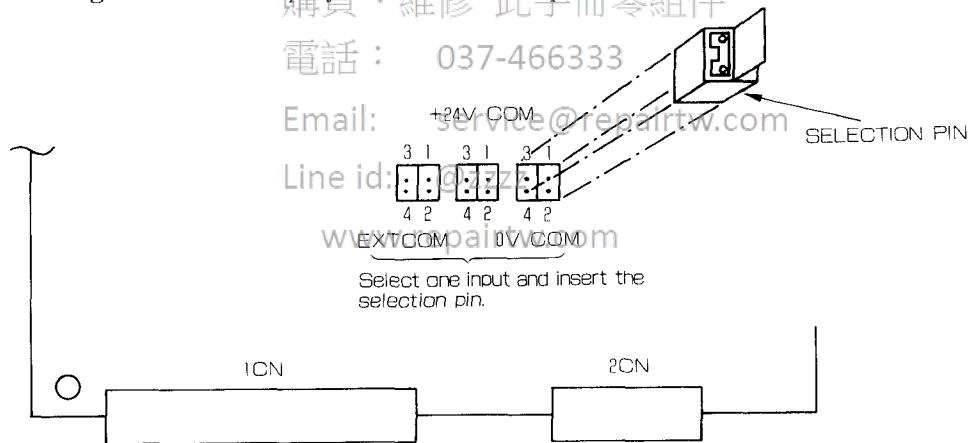

- ⚠- Before changing the selection pin, turn OFF the power. Insert the selection pin in a position shown in the figure.

Fig. 4.1 Input Method Selection Pin

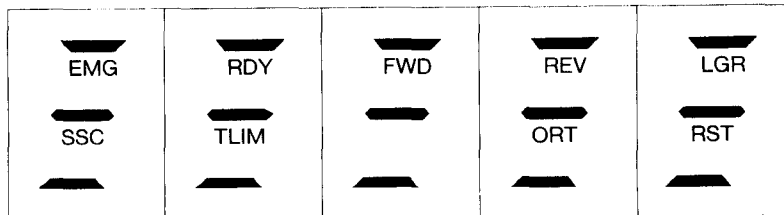

Note : Input signal of "Closed Status" is indicated by the lamps.

Fig. 4.2 Display of Input Status (V1-09)

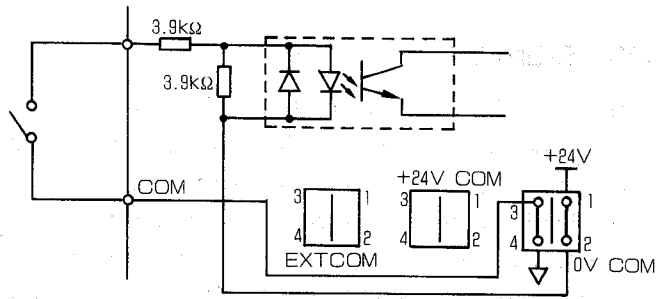

(a) 0V Common Input Method Interface

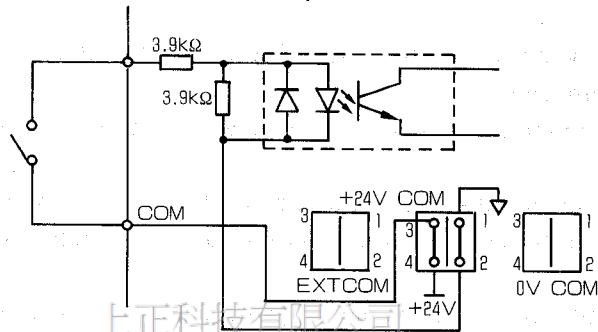

(b) +24V Common Input Method Interface

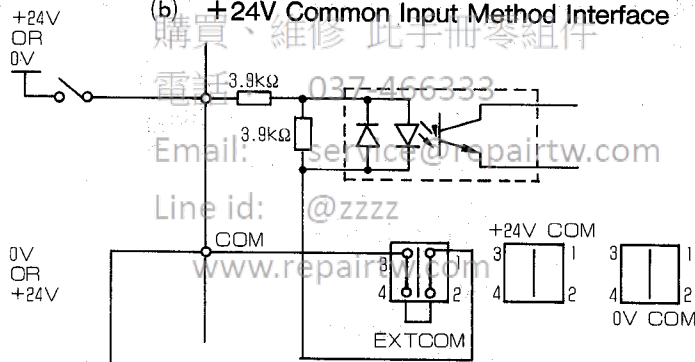

(c) External Common Input Method Interface

Fig. 4.3 Input Interface Circuit

Table 4.1 Functions of Sequence Input Signals

Signal	Connector No.	Pin No.	On Signal	Function														
Ready RDY	1CN	36	CLOSE	<ul style="list-style-type: none"> If RDY is closed during operation, the base is immediately blocked to shut down motor current. Close RDY again to restart. By changing the selection signal C1-37 (SEL 2) bit 3 and 2, RDY becomes the following status. <ul style="list-style-type: none"> “I” : When RDY is opened during run, the motor will rapidly be stopped by regenerative braking. Then, the current is interrupted to open the MC. “I” : When RDY is opened during run, the motor will rapidly be stopped by regenerative braking. Then, the current is interrupted, but, MC is still closed. When RDY is not used, always close No.36 pin. Then, when 0V common or +24V common input method is selected, connect 1CN-pin No.36 to pin No.33. When external common input method is selected, close RDY externally. 														
Forward Run FWD Reverse Run REV	1CN	37 38	CLOSE CLOSE	<ul style="list-style-type: none"> With RDY and EMG closed and the speed reference positive, when FWD is closed, the motor runs CCW as viewed from drive end ; and when REV is closed, the motor runs CW. Therefore, when speed reference and run signals are combined, the motor runs in the directions shown below. <table border="1" style="margin-left: auto; margin-right: auto;"> <thead> <tr> <th rowspan="2">SPEED REFERENCE</th> <th colspan="2">+</th> <th colspan="2">-</th> </tr> <tr> <th>FWD</th> <th>CCW</th> <th>CW</th> <th>CCW</th> </tr> </thead> <tbody> <tr> <td>Operation Signal</td> <td>REV</td> <td>CW</td> <td>CCW</td> <td></td> </tr> </tbody> </table> <ul style="list-style-type: none"> When the signal is opened during run, the motor is stopped by the regenerative braking and when the motor speed reaches to zero, the motor current is interrupted by gate blocking. The acceleration time is set with the soft start constants (C1-10 T_{SFS}). The time between halt and 100% rated speed can be set between 0.1 and 180.0 seconds. However, for some load inertia values, the accel/decel time may be exceeded than the soft start set time. FWD and REV should be closed at least 15ms after EMG are closed. FWD and REV should not be closed before EMG and RDY. <div style="text-align: center;"> <p>15ms and above</p> </div> <ul style="list-style-type: none"> When both FWD and REV are closed, the motor stops. In this case, if whichever of them becomes open, the motor resumes running, so that care must be taken to avoid accident. 	SPEED REFERENCE	+		-		FWD	CCW	CW	CCW	Operation Signal	REV	CW	CCW	
SPEED REFERENCE	+		-															
	FWD	CCW	CW	CCW														
Operation Signal	REV	CW	CCW															

Table 4.1 Functions of Sequence Input Signals (Cont'd)

Signal	Connector No.	Pin No.	On Signal	Function
Forward Run <input type="checkbox"/> FWD Reverse Run <input type="checkbox"/> REV	1CN	37 38	CLOSE CLOSE	<ul style="list-style-type: none"> When <input type="checkbox"/> FWD or <input type="checkbox"/> REV is closed, the motor runs at the speed specified by a speed reference. Be sure to first set a speed when running the motor.  <ul style="list-style-type: none"> When a trouble occurs during run, base is blocked immediately to interrupt the motor current. Open <input type="checkbox"/> FWD and <input type="checkbox"/> REV signals before turning power ON. If either <input type="checkbox"/> FWD or <input type="checkbox"/> REV is opened, motor cannot be started.
Emergency Stop <input type="checkbox"/> EMG	1CN	35	OPEN	<ul style="list-style-type: none"> Operation is ready within 2.5 seconds after closing <input type="checkbox"/> EMG. During the delay time, the main circuit capacitor is changed. When <input type="checkbox"/> EMG is opened during run, the motor is quickly stopped by regenerative braking, and then, the current is interrupted and MC is opened. Even when the motor is not stopped, the current is automatically interrupted after 10 seconds. After opening <input type="checkbox"/> EMG, operation will not be ready even after closing <input type="checkbox"/> EMG again unless <input type="checkbox"/> FWD and <input type="checkbox"/> REV are opened. When <input type="checkbox"/> EMG is not used, always close No.35 pin. Then, when 0V common or +24V common input method is selected, connect 1CN-pin No.35 to pin No.34. When external common input method is selected, close No.35 pin externally.
Torque Limit <input type="checkbox"/> TLIM Incremental Signal <input type="checkbox"/> INC	1CN	41	CLOSE	<ul style="list-style-type: none"> This signal temporarily limit motor torque during operation. When <input type="checkbox"/> TLIM is closed, torque is limited. In this state, torque limiting signal <input type="checkbox"/> TLE is output. The torque limit level when <input type="checkbox"/> TLIM is input can be set up for external operation torque limit level C1-24 (TL_{EXT}) from 5% to 120% of the 15-minute rating.  <ul style="list-style-type: none"> When <input type="checkbox"/> TLIM is not to be used, leave pin No.41 open. <hr/> <ul style="list-style-type: none"> This signal is used for incremental operation during orientation control. The <input type="checkbox"/> INC signal is input to pin 41 when bit 0 and bit 1 of select signal C1-36 (SEL1) are set to "1" and "1", respectively. <input type="checkbox"/> INC is effective when input simultaneously with or before <input type="checkbox"/> ORT. If <input type="checkbox"/> INC is input when power is turned ON or <input type="checkbox"/> INC is input without performing the absolute positioning, an incremental error (code: F-d15) occurs. When <input type="checkbox"/> ORT is input after <input type="checkbox"/> INC, incremental operation is started from the stop position at that time. Therefore, absolute positioning must be performed in advance if positioning precision is required.

Table 4.1 Functions of Sequence Input Signals (Cont'd)

Signal	Connector No.	Pin No.	On Signal	Function																				
Soft-start Cancel [SSC] Servo Mode Signal [SV]	1CN	40	CLOSE ----- CLOSE	<ul style="list-style-type: none"> This signal is for cancelling the soft start function so that speed reference is changed by speed command without delay, for inching or other special control modes. When [SSC] is closed, the accel/decel set time is disregarded, and the motor is accelerated or decelerated in short time by the current limit accel/decel function. When [SSC] is not to be used, leave pin No.40 open. <hr/> <ul style="list-style-type: none"> Selecting "1" on bit 3 of selection signal C1-36 (SEL 1) permits change to servo mode for solid tap, etc. <p>SEL 1</p> <table style="margin-left: 40px;"> <tr> <td>Bit</td> <td>7</td> <td>6</td> <td>5</td> <td>4</td> <td>3</td> <td>2</td> <td>1</td> <td>0</td> </tr> <tr> <td></td> <td> </td> <td> </td> <td> </td> <td> </td> <td> </td> <td> </td> <td> </td> <td> </td> </tr> </table> <div style="margin-left: 40px;"> <table border="1" style="border-collapse: collapse;"> <tr> <td style="padding: 2px;">1</td> <td style="padding: 2px;">0</td> </tr> </table> <p> "1" : Soft start cancel at 1CN-40 "close" "0" : Changes to Servo mode at 1CN-40 "close" (The gain of speed loop, etc. changes to servo mode) </p> </div> <ul style="list-style-type: none"> The following control constants are effective only when servo mode is selected: <ul style="list-style-type: none"> Speed control ratio gain: C1-05, 07 Speed control integral time constant: C1-06, 08 Servo mode flux level: C1-31 Servo mode base speed ratio: C1-32 	Bit	7	6	5	4	3	2	1	0										1	0
Bit	7	6	5	4	3	2	1	0																
1	0																							
Alarm Reset [RST]	1CN	44	CLOSE ↓ OPEN	<ul style="list-style-type: none"> This signal is for restoring the run ready status after eliminating the cause of the tripping of the protective circuit, as the result of overcurrent or overload. [RST] is effective only after the tripping of a protecting circuit. While [FWD] or [REV] is closed, or [ORT] is closed, resetting is not possible. The [RESET] switch incorporated in the digital operator equivalent to this signal in function. Resetting is effected by [RST] edge signal. Therefore, close [RST] and open it. In the protective circuit sequence, malfunction has priority. An example of the timing chart for resetting is given below. <div style="text-align: center; margin-top: 20px;"> <p>The timing chart illustrates the sequence of events for resetting after a protective circuit trip. It shows the states of several signals over time: OVERLOAD PROTECTION (OL) which is initially closed and then opens; FWD (forward) which is initially closed and then opens; RST (reset) which is initially open and then closes, then opens, then closes again; RUN which is initially open and then closes; FAULT INDICATION F-700 which is initially open and then closes; MALFUNCTION SIGNAL which is initially open and then closes; PROTECTIVE CIRCUIT TRIP which occurs when OL is closed and FWD is closed; and RESET END which occurs when RST is closed and the protective circuit trip is cleared.</p> </div>																				

Table 4.1 Functions of Sequence Input Signals (Cont'd)

Signal	Connector No.	Pin No.	On Signal	Function						
Orientation ORT	1CN	43	CLOSE	<ul style="list-style-type: none"> This is an instruction signal of electric orientation. When ORT is input, the spindle is immediately moved and stopped at a specified position. Open ORT when replacement of a tool or workpiece, or any other work has been performed in the positioned status. If an emergency stop occurred during orientation, operation cannot be restarted unless ORT is opened. Open ORT before turning power ON. Otherwise, operation cannot be started. If there is no orientation card (option), use the motor encoder signal for positioning. When ORT is not to be used, disconnect pin 43. 						
L Gear Selection Signal LGR		39	CLOSE	<ul style="list-style-type: none"> These signals change parameters such as gear ratio and gain to optimize control according to gear selection of the spindle. Use the gear select signals as listed in the table below. <table border="1" style="margin-left: auto; margin-right: auto;"> <thead> <tr> <th>LGR</th> <th>Function</th> </tr> </thead> <tbody> <tr> <td>OPEN</td> <td>H-gear selection</td> </tr> <tr> <td>CLOSE</td> <td>L-gear selection</td> </tr> </tbody> </table> <p style="text-align: center;">• For gear ratio and gear selection, refer to Table 4.2.</p>	LGR	Function	OPEN	H-gear selection	CLOSE	L-gear selection
LGR	Function									
OPEN	H-gear selection									
CLOSE	L-gear selection									

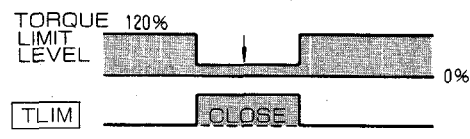
上正科技有限公司
 購買、維修 此手冊零件
 電話： 037-466333

Table 4.2 Gear Selection by Gear Ratio

Number of Speeds	Gear Ratio	Gear Ratio ($= \frac{\text{Spindle Speed}}{\text{Motor Speed}}$)	Gear Selection L Gear (LGR)
1	—	$\frac{2.5}{0.6}$	×
	—	$\frac{0.8}{0.05}$	○
2	HIGH	$\frac{2.5}{0.6}$	×
	LOW	$\frac{0.8}{0.05}$	○

Note: Contact your YASKAWA representative on the other combinations of gear ratio.

○...ON, contact closed
×...OFF, contact open

4.2 SPEED REFERENCE

Table 4.3 Speed Reference Input

Signal	Connector No.	Pin No.	Function
Analog Speed Reference SCOM	ICN	3	<ul style="list-style-type: none"> Rated input voltage is $\pm 10\text{VDC}$. If the rated motor speed cannot be obtained at rated input voltage, it can be adjusted by motor speed adjustment constant C1-12 (SADJ). The allowable input voltage is $\pm 12\text{VDC}$. However, since the controller limits it at 105% or 110% of rated value, the rated speed of the motor is limited at 105% or 110% of the rated speed. Select the level of speed limit by bit 5 of select signal C1-38 (SEL3). When "1" is set for the bit 5, 105% is set up. When "1" is set, 110% is set up. The input impedance of SCOM is $50\text{ k}\Omega$. With various combinations of SCOM and run signals, speeds and directions of rotation shown below are obtained. <div style="text-align: center;"> </div> <ul style="list-style-type: none"> SCOM is effective and the motor runs when run signal FWD or REV is closed. If SCOM is set to 0V while forward or reverse run signal is being input, the motor may fail to stop completely. To stop the motor completely, open both the forward and reverse run signals. (While either is closed, current flows.) To improve noise resistance, use shielded lead for the SCOM circuit. When setting SCOM manually, the reference voltage (+15V) of the controller can be used, provided the current is kept up to 10 mA. <div style="text-align: center;"> </div>

4.3 SEQUENCE OUTPUT SIGNALS

Use these output signals under the following conditions.

- (1) Both +24V common and 0V common are available output methods.
- (2) Signal output is insulated by a photocoupler. Prepare +24V power supply to output signals.
- (3) When 24V is applied, the output current capacity is up to 50mA.
- (4) When an inductive load such as an external relay is to be switched ON and OFF, be sure to connect a spark suppressor in parallel with the load. The maximum allowable voltage for the output circuit is 26V.
 - ★— If greater voltage than the maximum allowable is applied, the photocoupler of the output circuit may be damaged.
- (5) For a capacitive load, connect a protective resistor in series with the load to limit the current.
 - ★— If there is no protective resistor, excess current flows when the photocoupler is operated, and the components may be damaged.
- (6) Fig. 4.4 shows the output circuit. Table. 4.4 lists the functions of signals.
- (7) The ON/OFF status of the output signals can be checked by control signal V1-10. The status is displayed on the digital operator LEDs as shown in Fig. 4.5.

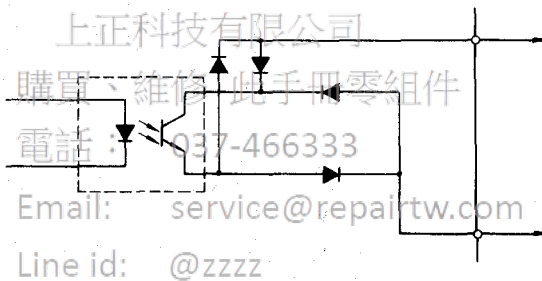
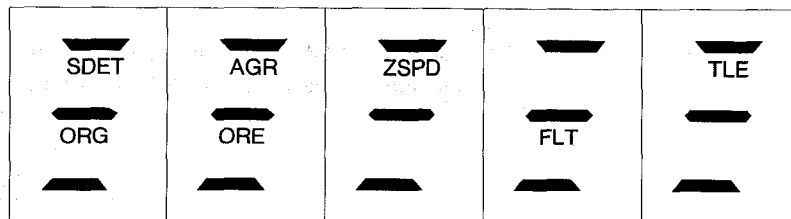

Fig. 4.4 Output Interface Circuit



Note: Output signal of closed status are indicated by the lamps.

Fig. 4.5 Display of Output Status (V1-10)

Table 4.4 Functions of Sequence Output Signals

Signal	Connector No.	Contact and Pin No.	Function
Zero Speed ZSPD	1CN		<ul style="list-style-type: none"> When the motor speed drops below the set level, ZSPD is closed. Once ZSPD is closed, it remains closed for 50 ms.  <ul style="list-style-type: none"> The zero-speed detection level can be set up for control constant C1-19 (ZS_{LVL}) from 3r/min. to 60r/min. Since ZSPD is output irrespective of FWD and REV, it can be used as a safety run interlock signal.
Speed Agreed AGR	1CN		<ul style="list-style-type: none"> When the motor speed enters the preset range of SCOM, AGR closes. However, in gateblock status, it is not output. Once AGR is closed, it remains closed for 50 ms. When this signal is used as an answer to S command in NC program operation, the program is advanced to the next step. Speed agreed signal setting range of $\pm 10\%$ to $\pm 50\%$ of rated speed is selected with speed agreed signal detection width C1-20 (AGR_{BD}) Operation Example of Speed Agreed Signal  <p>電話：037-466333 Email: service@repairtw.com Line id: @zzzz www.repairtw.com</p>
Speed Detection SDET	1CN		<ul style="list-style-type: none"> When the motor speed drops below a preset level, SDET is closed. The speed detection level is set between 0 and 100% speed with the preset constants C1-21 (SD_{LVL})  <ul style="list-style-type: none"> Hysteresis width is set in the control constants C1-22 (SD_{HVS}) SDET operates regardless of the run direction signals.

Table 4.4 Functions of Sequence Output Signals (Cont'd)

Signal	Connector No.	Contact and Pin No.	Function
Torque Limit TLE			<ul style="list-style-type: none"> When external torque limit TLIM is input, TLE will be closed. TLE can be used as check signal for TLIM.
Orientation Completed ORE	1CN		<ul style="list-style-type: none"> ORE is closed when the spindle reached near the commanded stop position after ORT is input. While ORE is closed, resistant torque is generated against external force to compensate for positioning error. Therefore, tools and workpieces must be replaced while ORE is closed. If a great external force is applied and positioning error is increased, ORE is opened. Prepare an external sequence to judge it to be an orientation failure.
Spindle Home Position ORG	1CN		<ul style="list-style-type: none"> One pulse is output per one rotation of the spindle using the magnetic sensor signal. ORG is output when spindle runs at 1000 r/min. or less.
Fault FLT	1CN		<ul style="list-style-type: none"> When protective circuit for overcurrent or overload tripped, the motor current is instantly interrupted, and the motor stops after running by inertia. Upon current interruption, FLT is output. The FLT relay is closed at protective circuit operation. The contact is NONC contact. While FLT is being output, open operation signal FWD or REV and output a failure warning to the main system. FLT is displayed. Refer to FLM function. For the relationship between FLT and RST, refer to Table 4.1.

4.4 ENCODER PULSE OUTPUT CIRCUIT

[PAO *PAO PBO *PBO PCO *PCO] * indicates a reverse signal.

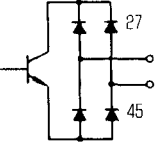
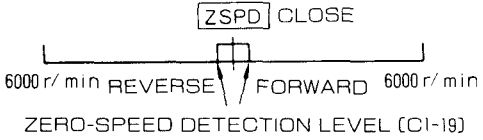
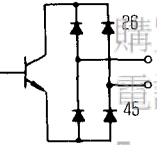
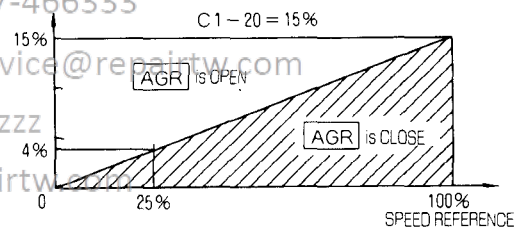
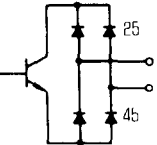
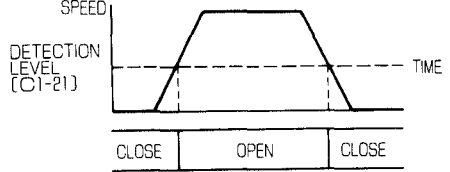
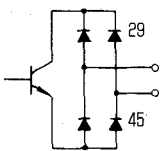
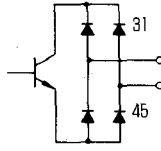
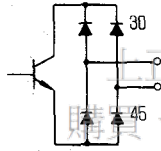
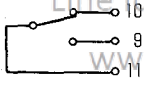
Encoders having home position signals (1024 pulses/rev) outputs phase-A, phase-B, and phase-C (home position) signals.

These signals can be used for position feedback signals. Specifications of output signals are as follows:

(1) Signal form

- Two-phase pulse with 90° phase difference (phase-A and -B)
- Original point pulse (phase-C)

(2) Output circuit and receiver circuit

The output circuit is a line driver in compliance with the RS-422-A specifications. Use line receivers of matched characteristics to convert the signals as shown in the connection circuit example in Fig. 4.6.

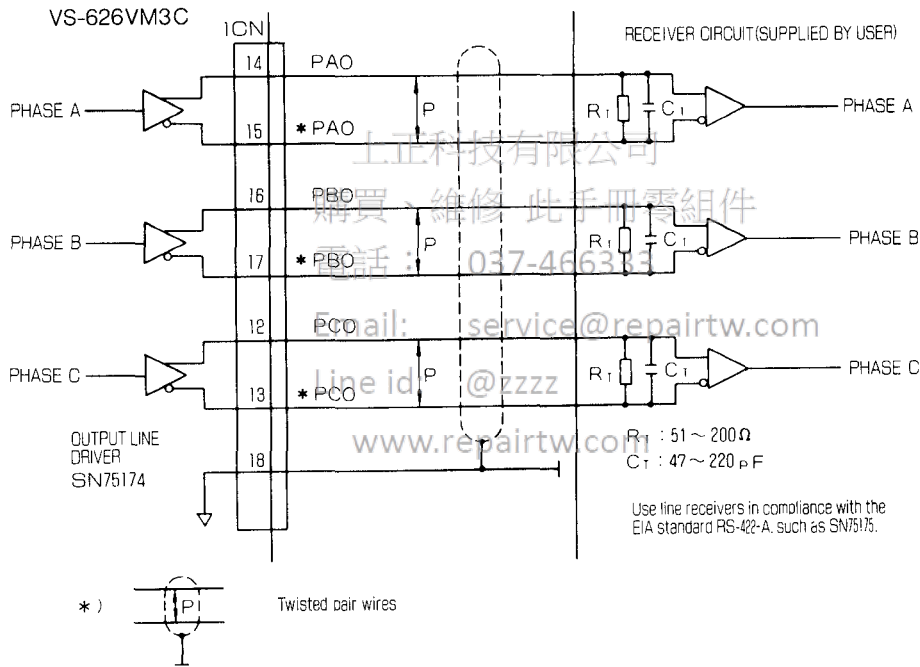

Fig. 4.6 Output Circuit and Receiver Circuit

(3) Output phase

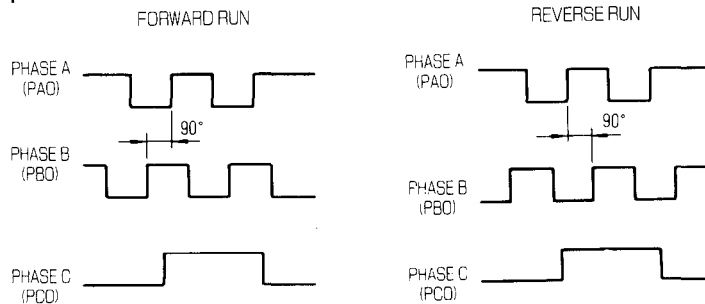

Fig. 4.7 Output Phase

4.5 ANALOG MONITOR SIGNALS

Use the analog output signals in the following conditions.

Table 4.5 Functions of Analog Output Signals

Signal	Connector No.	Pin No.	Function												
Speedometer SM	1CN	21	<ul style="list-style-type: none"> When an external speedometer is connected, the motor speed can be monitored. Speedometer signal terminal outputs DC voltage signal proportional to the motor speed, regardless of the run direction. Select a voltmeter as a speedometer which satisfies the following specifications. <table border="1"> <thead> <tr> <th>Item</th> <th>Specifications</th> </tr> </thead> <tbody> <tr> <td>Name</td> <td>Voltmeter</td> </tr> <tr> <td>Activation</td> <td>Moving coil type</td> </tr> <tr> <td>Rating</td> <td>10V full-scale</td> </tr> <tr> <td>Internal Resistance</td> <td>10kΩ</td> </tr> <tr> <td>Class</td> <td>2.5 class or above</td> </tr> </tbody> </table> <ul style="list-style-type: none"> The level of speedometer signal is adjustable with the control constant C1-16 (SM_{ADJ}). Since C1-16 (SM_{ADJ}) is only for adjusting the speedometer, the actual speed is not influenced by it. The forward and reverse run speed accuracy is $\pm 3\%$ max. of the rated speed. 	Item	Specifications	Name	Voltmeter	Activation	Moving coil type	Rating	10V full-scale	Internal Resistance	10k Ω	Class	2.5 class or above
Item	Specifications														
Name	Voltmeter														
Activation	Moving coil type														
Rating	10V full-scale														
Internal Resistance	10k Ω														
Class	2.5 class or above														
Load Meter Signal LM	1CN	23	<ul style="list-style-type: none"> The load meter indicates the ratio of the actual load to the rated output of the motor. Select a voltmeter conforming to the same specifications as the speedometer. Load meter signal can be adjusted with the control constants C1-17 (LM_{ADJ}) and C1-18 (LM_{FS}). 												

Note: Use pin No. 22 or 24 for 0V meter.

5 ORIENTATION CONTROL

5.1 ENCODER TYPE ARBITRARY POSITION ORIENTATION CONTROL

By using the signals of the load axis encoder connected with the load axis (spindle) with speed change ratio of 1 : 1, such as lathes, one rotation is divided into 4096 (resolution : 0.088°) for positioning based on 12-bit binary or 3-digit BCD stop position commands. For this control, as shown in Fig. 5.8, positioning command orientation signal, stop position command and orientation card are needed in addition to signals such as **FWD**, **REV**, etc.

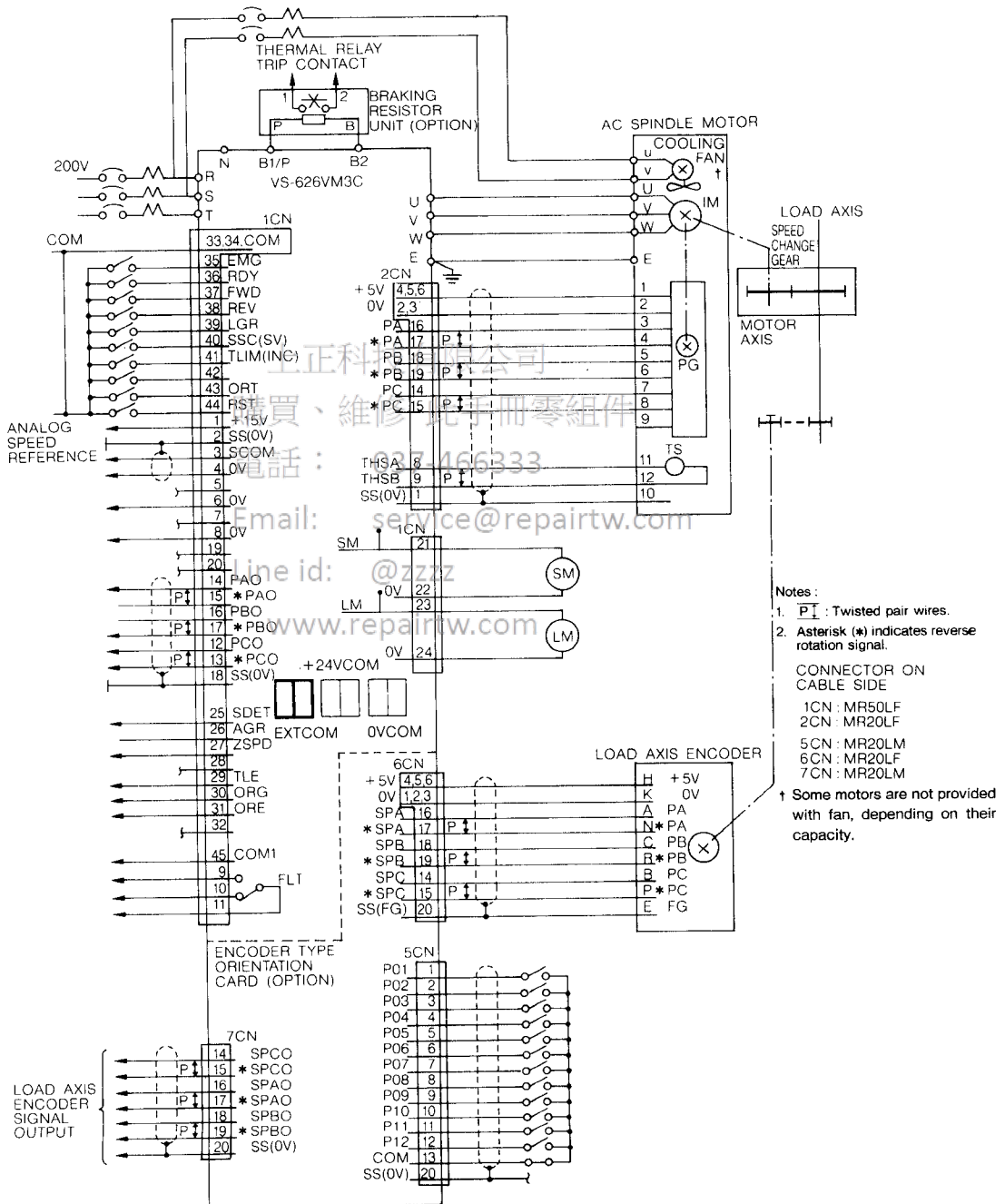

Fig. 5.1 Arbitrary Position Stop Control by Load Axis Encoder



If the orientation function is to be used under the following conditions, adjust the machine and adjust parameters before starting.

- (1) When the orientation function is to be used for the first time after VS-626VM3C was connected to the driven machine.
- (2) After exchanging the motor or the encoder.
- (3) After altering wiring between equipment.

For details about tuning, refer to the adjustment procedure.

The following two types of arbitrary positioning:

- (1) Absolute positioning
- (2) Incremental positioning

They are explained below.

When the load axis and the motor axis are directly coupled, orientation positioning can be performed by motor encoder signal.

5.1.1 Arbitrary Position Stop Control by Load Axis Encoder

(1) Absolute positioning

Absolute positioning is used to perform positioning at the specified stop position with the spindle zero point as reference. Therefore, when the specified stop position is "0", the spindle stops at the spindle zero point; when it is "90", the spindle stops at 90° after proceeding in the CW direction. When the orientation signal is input during rotation (or stopping), the spindle speed decelerates or accelerates to the set orientation speed. After the set speed is reached, the encoder phase C signal is checked. Then the axis stops at the position specified by the servo loop, and at the same time, it outputs the orientation completion signal (ORE).

Since the servo loop keeps operating even after completion of orientation unless the orientation completion signal is turned OFF, the spindle hardly strays away from the positioning point even if external force is applied to the spindle.

Fig. 5.2 is the time chart of absolute positioning.

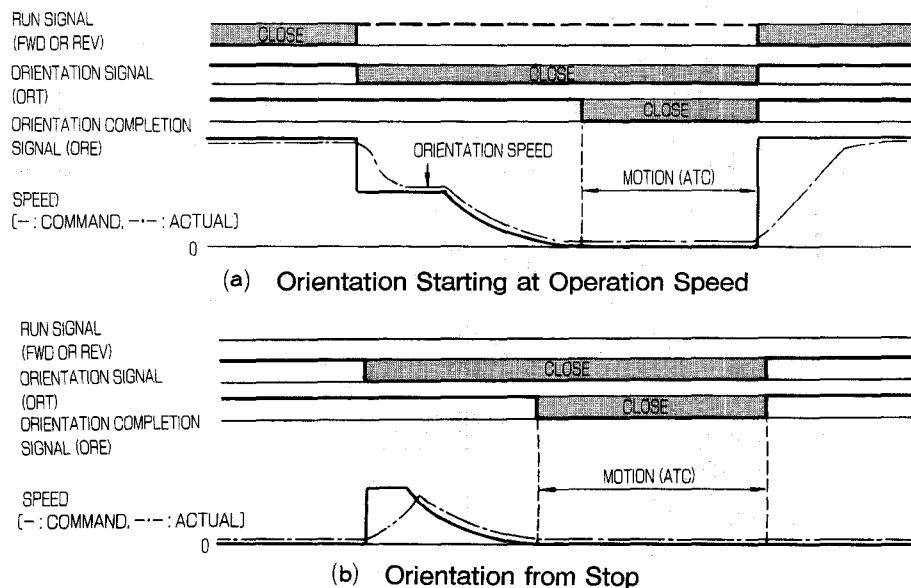

Fig. 5.2 Time Chart of Absolute Positioning

(2) Incremental positioning

Incremental positioning is used to perform positioning at a new stop position which is determined by adding the specified rotation moving amount (angle) to the current stop position.

By inputting the incremental signal and inputting the orientation signal again after completion of absolute positioning, the spindle stops at the new stop position, and at the same time, it outputs the completion signal.

In this mode, each time the orientation signal is input, the spindle proceeds by the specified rotation moving amount.

Fig. 5.3 shows the time chart of the incremental positioning operation.

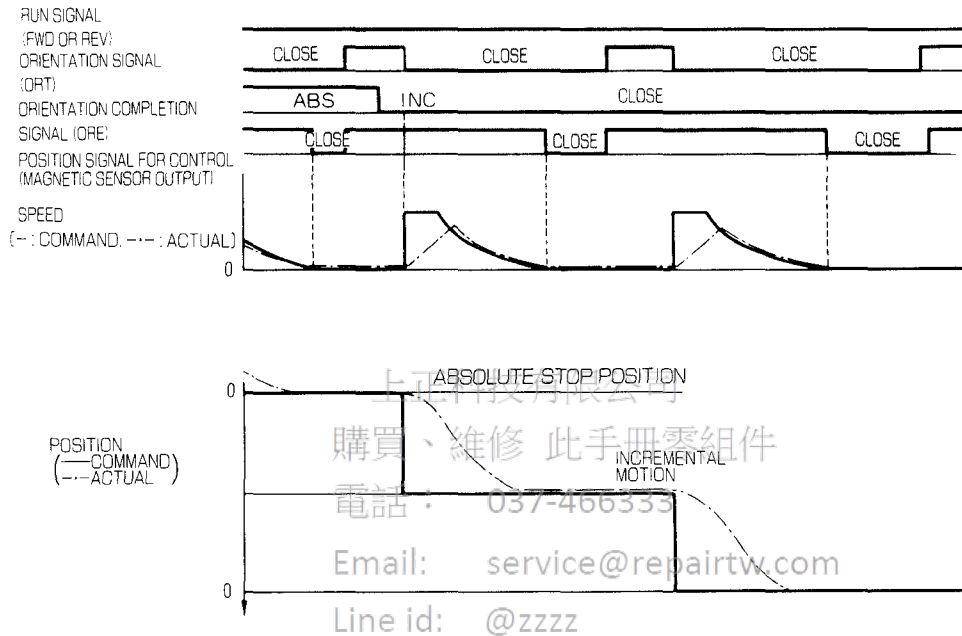

Note: When incremental positioning is performed, a position shift must not be generated while the orientation signal is turned OFF. If a shift occurs, the stop positioning accuracy may not be obtained.

Fig. 5.3 Incremental Positioning

5.1.2 Home Position Stop Control by Motor Encoder

When the spindle and the load axis are coupled at a transmission rate of 1 : 1, one rotation (angle) of the axis is divided into 4096 (at a resolution of 0.088°) by using the motor encoder signal and the positioning is moved to the position determined by control constant C2-01.

As shown in Fig. 5.4, this control requires a positioning reference and orientation signals, adding to speed reference, forward-reverse run and other signals.

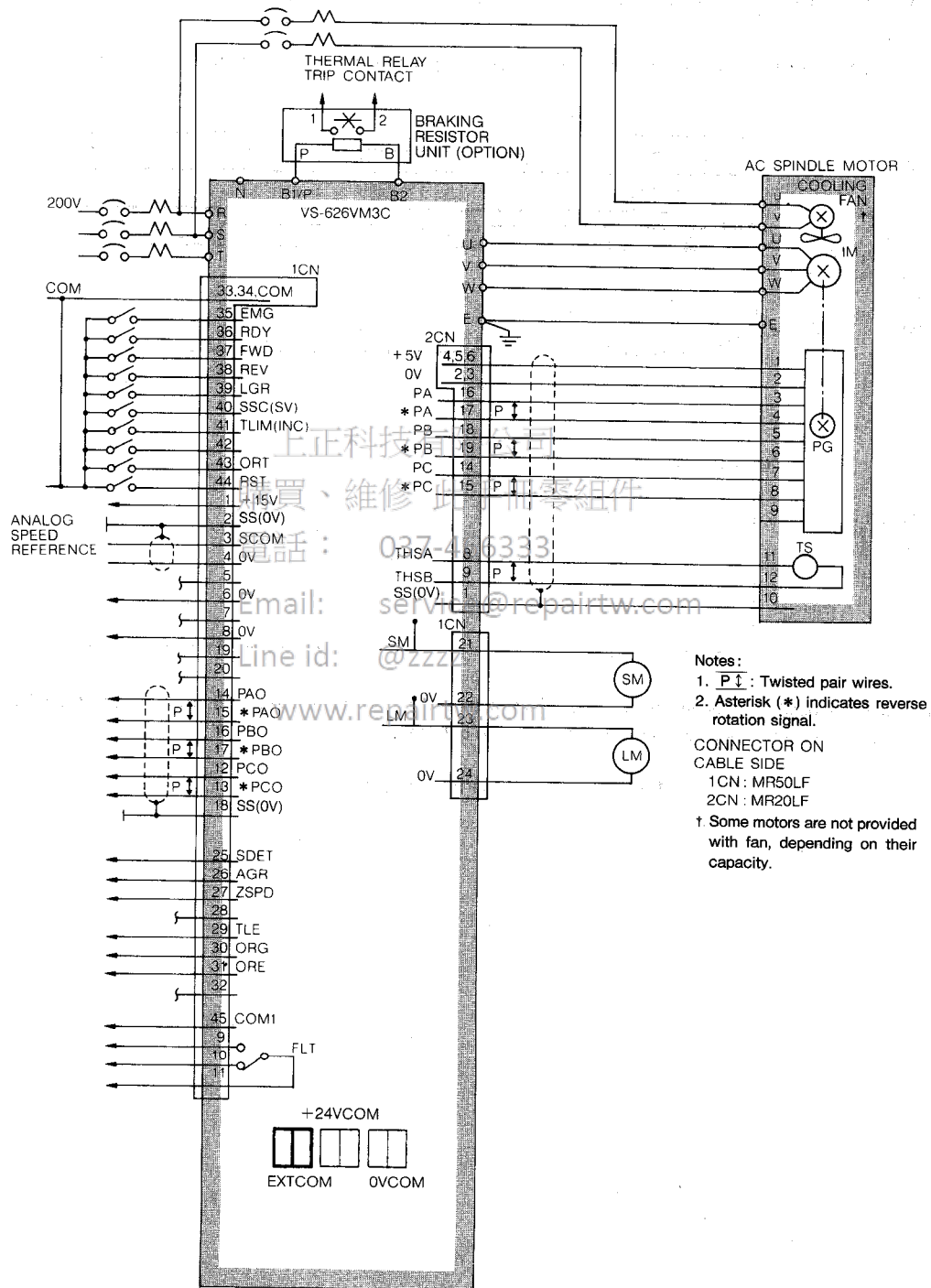

Fig. 5.4 Home Position Stop Control by Motor Encoder

5.1.3 Specifications of Encoder Type Orientation Control

Table 5.1 Standard Specifications

Item	Description
Positioning Method	Absolute or incremental method* ²
Positioning Detecting Method	Angle detected by load axis encoder phase A, B or C pulse
Stop Position* ¹	Stopped at the position determined by external command or internal setting with the load axis zero-point* ³ as reference.
Stop Position Repeating Accuracy* ¹	±0.2° or less
Resistant Torque* ¹	Continuous rated torque/±0.1° displacement* ⁴
Orientation Card	Code No.: ETC62103 _x .3
Load Axis Encoder Type	PC-1024ZLH (for load axis mounting) UTMSI-10AAB (motor encoder)

*1 : Excluding functional error such as backlash or eccentricity.

*2 : Incremental method is only acceptable for the load axis encoder method.

*3 : The zero point can be obtained by setting the constant memory to the number of offset pulse from load axis encoder phase C pulse startup at FWD run.

*4 : Continuous rated torque may not be obtained depending on gain setting. Also for quick load variation, displacement becomes larger.

上正科技有限公司

購買、維修 此手冊零組件

電話： 037-466333

Email: service@repairtw.com

Line id: @zzzz

www.repairtw.com

5

Table 5.2 Encoder Specifications

Item	Description		
Type	PC-1024ZLH-4K-68	PC-1024ZLH-6K-68	UTMSI-10AAB†
Max. Speed* (r/min)	4000	6000	10000
Power Supply	+5VDC ±5%		—
Dissipated Current	Max 350 mA.		—
No. of Pulses	Phase-A, -B 1024 pulses/rev. Phase-C 1 pulses/rev.		
Output	Each phase is of parallel output by line driver. SN75113 SN75158		
Max. Response Frequency	Phase-A, -B 80kHz Phase-C 70kHz (4690r/min)	Phase-A, -B 120kHz Phase-C 117kHz (7000r/min)	Phase-A, -B 188kHz Phase-C 183kHz (11000r/min)
Accumulated Pitch Error	Within 33% of Phase-A, -B signal frequency		Within 50% of Phase-A, -B signal frequency
Pitch Error	Within 12.5% of Phase-A, -B signal frequency		
Input Shaft Inertia	Max. $1 \times 10^{-3} \text{kgf} \cdot \text{cm} \cdot \text{s}^2$		$58.7 \times 10^{-3} \text{kgf} \cdot \text{cm} \cdot \text{s}^2$
Input Shaft Torque	Max. 1 kgf · cm		—
Input Shaft Allowable Load (Thrust) (Radial)	At standstill At running Max. 10 kg Max. 4kg Max. 20 kg Max. 6kg		—
Construction	Dustproof, dripproof (With oil seal)		Motor flange mounting
Output Connector (Main Unit Side) (Cable Side) (Manufacturer)	MS3102A20-29P MS3106A20-29S JAPAN AVIATION ELECTRONICS INDUSTRY, LTD.		MLR-12 MLP-12 (Nippon Pressure Terminal Sales Co.,Ltd.)
Mass	1.5kg		0.33kg (Encoder disk)
Ambient Temperature	0 to +60°C		
Humidity	10 or 95% RH (Non-condensing)		

* Shows upper limit speed in practical use.

† Type UTMSI-10AAB is an encoder housed in the motor.

5.1.4 Dimensions in mm (in inches)

(1) Encoder Type Orientation card (Type ETC62103X.3)

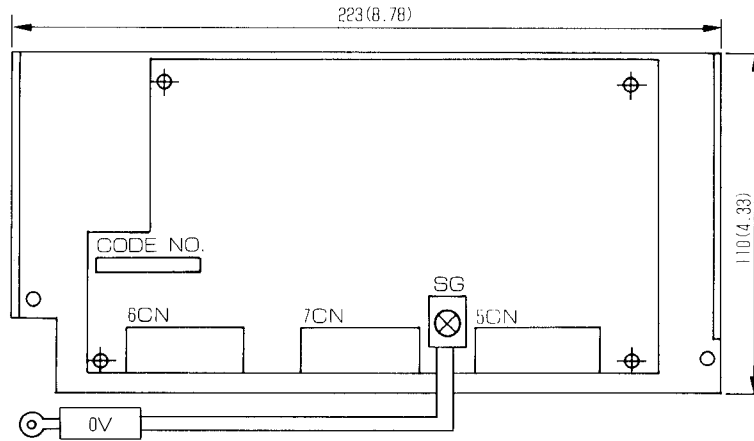

Note: Connect SG terminals to SG controller screw terminals.

Fig. 5.5 Dimensions of Orientation Card

(2) Encoder for load axis (Type PC-1024ZLH-K-68)

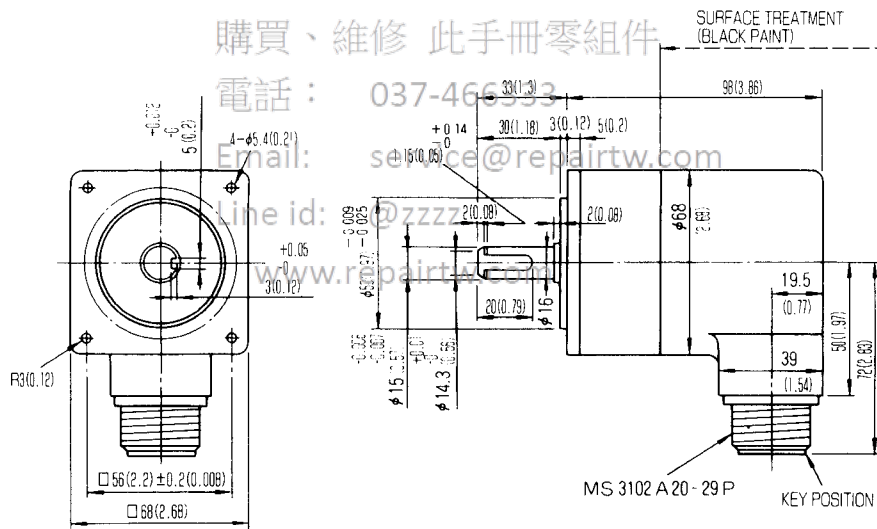

- Notes:
1. Install the encoder with the greatest possible care, so as not to generate backlash, because it will lead to a positional deviation.
 2. Besides this type of load axis encoder, the encoder without a flange and the encoder with a 160 mm flange are available.

Fig. 5.6 Dimensions of Encoder for Load Axis

5.1.5 Connections

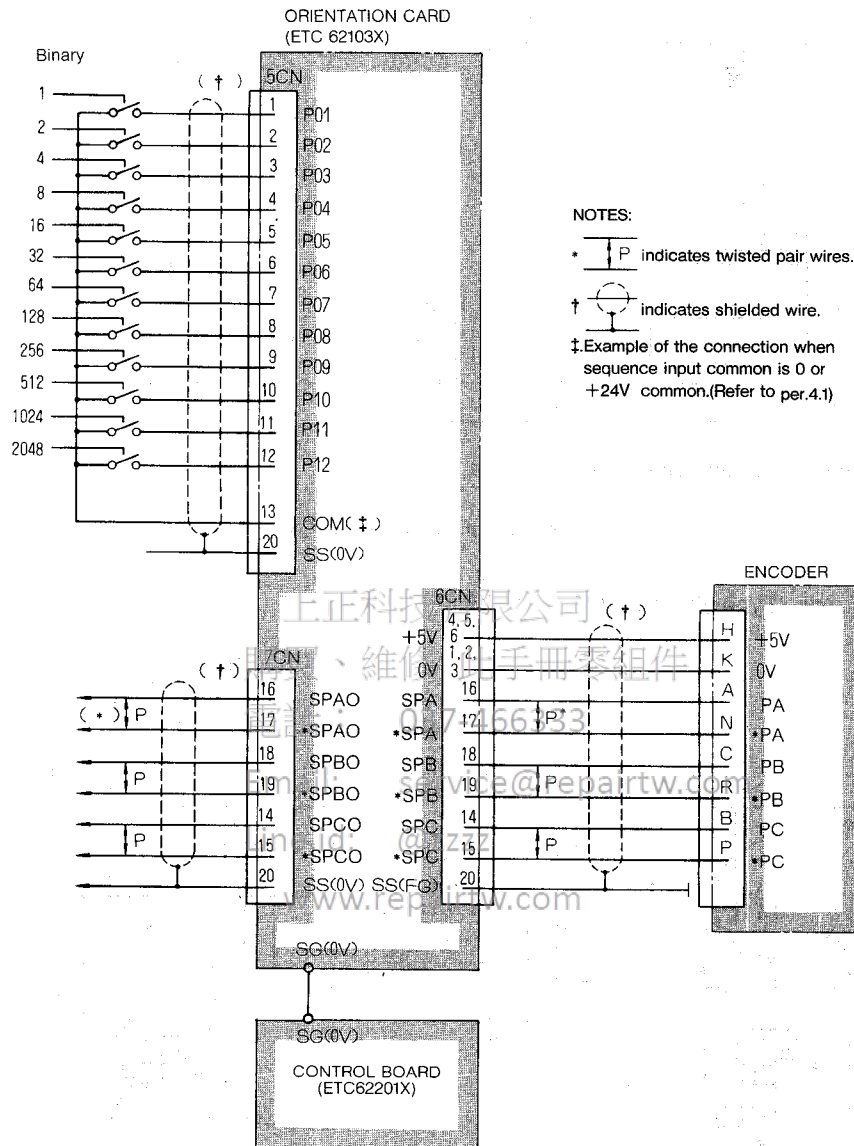

Fig. 5.7 Interconnections

5.1.6 Control Signal Connectors Terminal Layout

14	15	16	17	18	19	20
-	-	-	-	-	-	SS (0V)
8	9	10	11	12	13	
P08	P09	P10	P11	P12	COM	
1	2	3	4	5	6	7
P01	P02	P03	P04	P05	P06	P07

PC Board Connector: MR-20RFAG
Cable Side Connector: MR-20LM (G)

(a) 5CN (Stop position reference input)

20	19	18	17	16	15	14
SS (FG)	*SPB	SPB	*SPA	SPA	*SPC	SPC
13	12	11	10	9	8	
*CPB	CPB	*CPA	-	CPA	*CPC	
7	6	5	4	3	2	1
CPC	+5V	+5V	+5V	0V	0V	0V

PC Board Connector: MR-20RMAG
Cable Side Connector: MR-20LF (G)

(b) 6CN (Load axis encoder signal input)

14	15	16	17	18	19	20
SPCO	*SPCO	SPA0	*SPA0	SPBO	*SPBO	SS (0V)
8	9	10	11	12	13	
-	-	-	-	-	-	
1	2	3	4	5	6	7
-	-	-	-	-	-	-

PC Board Connector: MR-20RFAG
Cable Side Connector: MR-20LM (G)

(c) 7CN (Load axis encoder signal output)

- Notes: 1. The layout of pins is for the case where the connectors on the PC board are viewed from the fitted part.
2. In the diagram, the symbol □ represents an input signal and □ an output signal.
3. Asterisk(*) shows the reverse signals.

Fig. 5.8 Connector Pin Location

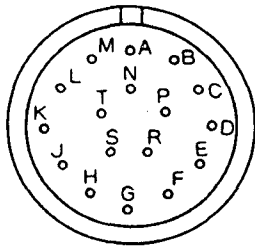

Main unit side MS3102A20-29P
 Cable side MS3108A20-29S (Angle plug)
 MS3106A20-29S (Straight plug)
 MS3057-12A (Cable clamp)
 Made by Japan Aviation Electronics Industry, Ltd.

A	B	C	D	E	F	G	H	I
PA	PC	PB	-	FG	-	-	+5V	-
K	L	M	N	P	R	S	T	
0 V	-	-	* PA	* PC	* PB	-	-	

* : Reverse signals

Fig. 5.9 Connector Pin Arrangement

5.1.7 Notes on Installing and Wiring of Encoder

- (1) Limit the length of signal cable between orientation card and encoder to less than 20 meters.
- (2) We have available the signal cable described in the specification shown in Table 5.3. You can purchase this optional item in the standard lengths according to your requirement.
- (3) During installation, keep the power cable and signal cable apart from each other to prevent interferences from electrical noise.
- (4) During normal rotation of spindle, if the encoder rotates clockwise as viewed from the spindle, interchange A- and B-phases as shown in Fig. 5.10.

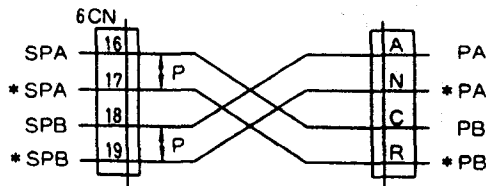

Fig. 5.10 Signal Lead Change

Table 5.3 Cable Specifications

Connection	Soldered Type	Caulking Type																																						
YASKAWA Drawing No.	DP 8409123	DE 8400093																																						
Manufacturer	Fujikura Cable Co.																																							
General Specifications	Double, KQVV-SW AWG22×3C AWG26×6P	KQVV-SB AWG26×10P																																						
	For Soldered Type	For Caulking Type																																						
	<table border="1"> <tr><td>A₁</td><td>Red</td></tr> <tr><td>A₂</td><td>Black</td></tr> <tr><td>A₃</td><td>Green (yellow)</td></tr> <tr><td>B₁</td><td>Bleu-White (blue)</td></tr> <tr><td>B₂</td><td>Yellow-White (yellow)</td></tr> <tr><td>B₃</td><td>Green-White (green)</td></tr> <tr><td>B₄</td><td>Orange-White (orange)</td></tr> <tr><td>B₅</td><td>Purple-White (purple)</td></tr> <tr><td>B₆</td><td>Grey-White (grey)</td></tr> </table>	A ₁	Red	A ₂	Black	A ₃	Green (yellow)	B ₁	Bleu-White (blue)	B ₂	Yellow-White (yellow)	B ₃	Green-White (green)	B ₄	Orange-White (orange)	B ₅	Purple-White (purple)	B ₆	Grey-White (grey)	<table border="1"> <tr><td>1</td><td>Blue-White</td></tr> <tr><td>2</td><td>Yellow-White</td></tr> <tr><td>3</td><td>Green-White</td></tr> <tr><td>4</td><td>Red-White</td></tr> <tr><td>5</td><td>Purple-White</td></tr> <tr><td>6</td><td>Blue-Brown</td></tr> <tr><td>7</td><td>Yellow-Brown</td></tr> <tr><td>8</td><td>Green-Brown</td></tr> <tr><td>9</td><td>Red-Brown</td></tr> <tr><td>10</td><td>Purple-Brown</td></tr> </table>	1	Blue-White	2	Yellow-White	3	Green-White	4	Red-White	5	Purple-White	6	Blue-Brown	7	Yellow-Brown	8	Green-Brown	9	Red-Brown	10	Purple-Brown
A ₁	Red																																							
A ₂	Black																																							
A ₃	Green (yellow)																																							
B ₁	Bleu-White (blue)																																							
B ₂	Yellow-White (yellow)																																							
B ₃	Green-White (green)																																							
B ₄	Orange-White (orange)																																							
B ₅	Purple-White (purple)																																							
B ₆	Grey-White (grey)																																							
1	Blue-White																																							
2	Yellow-White																																							
3	Green-White																																							
4	Red-White																																							
5	Purple-White																																							
6	Blue-Brown																																							
7	Yellow-Brown																																							
8	Green-Brown																																							
9	Red-Brown																																							
10	Purple-Brown																																							
Internal Composition and Lead Color Standard	Twisted pair wires	Twisted pair wires																																						
YASKAWA Standard Specifications	Standard length: 5m, 10m, 20m, Terminal ends are not provided (with connectors)																																							

5.1.8 Stop Position Reference Input Signal

The input signal circuit of the encoder orientation card is the same as the circuit explained in Par. 4.1, "SEQUENCE INPUT SIGNALS."

Table 5.4 Input Signal

Signal Name	Connector No.	Pin No.	On Level	Description																																																																														
Stop Position Reference	5CN	1 to 12	L (Close)	<ul style="list-style-type: none"> This is a stop position reference which is input from outside with the load axis home position assumed as 0 (zero). For position reference, either a 12-bit binary or 3-digit BCD may be selected. 																																																																														
				<table border="1"> <tr> <td rowspan="2">Absolute</td> <td>Binary</td> <td>Data 12-bit</td> <td>0° TO 359.9° (000_H to FFF_H)</td> </tr> <tr> <td>BCD</td> <td>Code 1-bit Data 3-digit (11-bit)</td> <td>-θ to +θ (-799_D to +799_D)</td> </tr> <tr> <td rowspan="2">Incremental</td> <td>Binary</td> <td>Code 1-bit Data 11-bit</td> <td>-180° to 179.9° (-000_H to 7FF_H)</td> </tr> <tr> <td>BCD</td> <td>Code 1-bit Data 3-digit (11-bit)</td> <td>-θ to +θ (-799_D to +799_D)</td> </tr> </table> <ul style="list-style-type: none"> Sign bit is - (minus) if in the ON state and + (plus) if in the OFF state. θ can be obtained as a product of the data of 3-digit BCD and C3-12 (P_{BCD}), the BCD stop position instruction resolution. The relation between command signals and number of pulses are shown in the following table. <table border="1"> <thead> <tr> <th rowspan="2">Bit No.</th> <th rowspan="2">Pin No.</th> <th colspan="2">Binary</th> <th>BCD</th> </tr> <tr> <th>Without Code</th> <th>With Code</th> <th>With Code</th> </tr> </thead> <tbody> <tr><td>1</td><td>1</td><td>1</td><td>1</td><td>1</td></tr> <tr><td>2</td><td>2</td><td>2</td><td>2</td><td>2</td></tr> <tr><td>3</td><td>3</td><td>4</td><td>4</td><td>4</td></tr> <tr><td>4</td><td>4</td><td>8</td><td>8</td><td>8</td></tr> <tr><td>5</td><td>5</td><td>16</td><td>16</td><td>10</td></tr> <tr><td>6</td><td>6</td><td>32</td><td>32</td><td>20</td></tr> <tr><td>7</td><td>7</td><td>64</td><td>64</td><td>40</td></tr> <tr><td>8</td><td>8</td><td>128</td><td>128</td><td>80</td></tr> <tr><td>9</td><td>9</td><td>256</td><td>256</td><td>100</td></tr> <tr><td>10</td><td>18</td><td>512</td><td>512</td><td>200</td></tr> <tr><td>11</td><td>19</td><td>1024</td><td>1024</td><td>400</td></tr> <tr><td>12</td><td>20</td><td>2048</td><td>Code</td><td>Code</td></tr> </tbody> </table> <ul style="list-style-type: none"> In the case of binary-coded decimal notation, the content of the signal varies with the polarity of the code. <If it is ON> Sum of number of pulses of the bits that are input. 0 0 1 0 1 0 0 1 0 0 1 ⋮ ⋮ ⋮ ⋮ 256 + 64 + 8 + 1 = 329 <If it is OFF> Complement of the sum of the number - (256 + 64 + 8 + 1) = -329 of pulses of the bits that are input. In the case of incremental, motions exceeding 180° are not available in the binary notation. However, in the case of BCD reference, depending on the setting of BCD stop position reference C2-12 (P_{BCD}) reference exceeding 180° (upto ±360° maximum) are available. 	Absolute	Binary	Data 12-bit	0° TO 359.9° (000 _H to FFF _H)	BCD	Code 1-bit Data 3-digit (11-bit)	-θ to +θ (-799 _D to +799 _D)	Incremental	Binary	Code 1-bit Data 11-bit	-180° to 179.9° (-000 _H to 7FF _H)	BCD	Code 1-bit Data 3-digit (11-bit)	-θ to +θ (-799 _D to +799 _D)	Bit No.	Pin No.	Binary		BCD	Without Code	With Code	With Code	1	1	1	1	1	2	2	2	2	2	3	3	4	4	4	4	4	8	8	8	5	5	16	16	10	6	6	32	32	20	7	7	64	64	40	8	8	128	128	80	9	9	256	256	100	10	18	512	512	200	11	19	1024	1024	400	12
Absolute	Binary	Data 12-bit	0° TO 359.9° (000 _H to FFF _H)																																																																															
	BCD	Code 1-bit Data 3-digit (11-bit)	-θ to +θ (-799 _D to +799 _D)																																																																															
Incremental	Binary	Code 1-bit Data 11-bit	-180° to 179.9° (-000 _H to 7FF _H)																																																																															
	BCD	Code 1-bit Data 3-digit (11-bit)	-θ to +θ (-799 _D to +799 _D)																																																																															
Bit No.	Pin No.	Binary		BCD																																																																														
		Without Code	With Code	With Code																																																																														
1	1	1	1	1																																																																														
2	2	2	2	2																																																																														
3	3	4	4	4																																																																														
4	4	8	8	8																																																																														
5	5	16	16	10																																																																														
6	6	32	32	20																																																																														
7	7	64	64	40																																																																														
8	8	128	128	80																																																																														
9	9	256	256	100																																																																														
10	18	512	512	200																																																																														
11	19	1024	1024	400																																																																														
12	20	2048	Code	Code																																																																														

5

上正科技(上海)有限公司
 購買、維修此系列零件
 電話：037-4663333
 Email: service@repairtw.com
 Line id: @zzz
 www.repairtw.com



If the orientation function is to be used under the following conditions, adjust the machine and adjust parameters before starting.

- (1) When the orientation function is to be used for the first time after 626VM3C was connected to the load machine.
- (2) After exchanging the motor, magnet, or magnetic sensor.
- (3) After altering wiring between equipment.
- (4) After exchanging the orientation card.

For details about tuning, see the adjustment procedure.

Home position stop operation with a magnetic sensor is explained in the following.

5.2.1 Stop at Home Position by Magnetic Sensor

If an orientation signal is input during rotation (or when the machine is stopped), the spindle speed is immediately accelerated (or decelerated) to the set orientation speed.

After the set speed is reached and the magneto on the spindle passes by the stop position, the servo loop uses a motor encoder signal to rotate the spindle until the centers of the magneto and the magnetic sensor match, and uses the magnetic sensor signal to stop the spindle at the home position. At the same time, an orientation completion signal (ORE) is output.

After orientation is completed, the servo loop operates until the orientation signal is turned OFF. Thus, the spindle is not easily moved from the home position even when external force is applied in the direction of rotation.

5

上正科技有限公司
購買、維修 此手冊零組件
電話: 03-8466333

Fig. 5.12 shows the time chart of positioning.

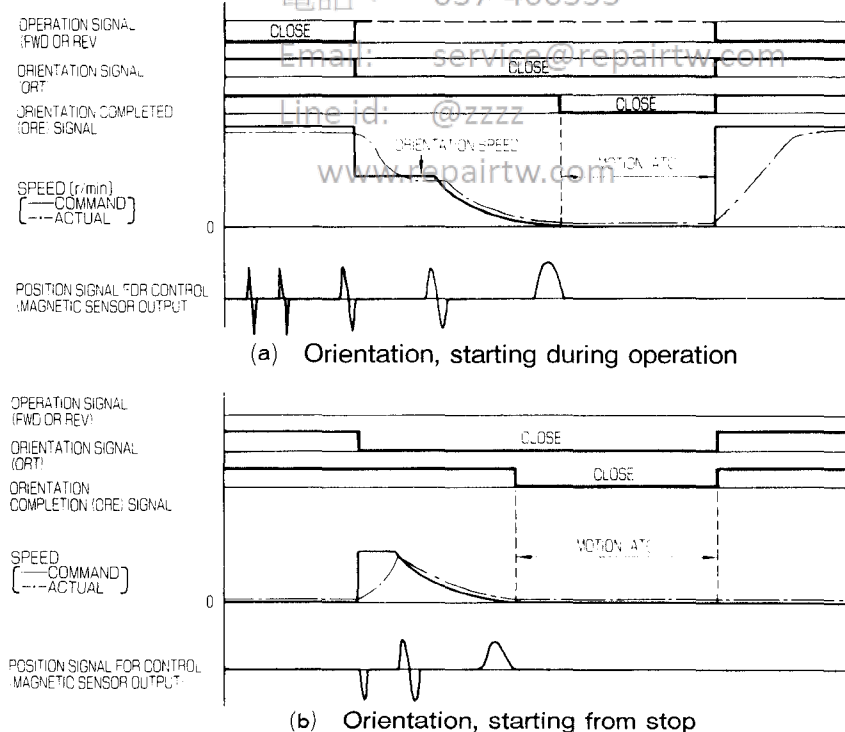

Note: If slip does not occur in transmission mechanism and parameters are set up properly, the servo loop stops the shaft smoothly.

Fig. 5.12 Positioning Operation

5.2.2 Magnetic Sensor Orientation Specifications

Table 5.5 Standard Specifications

Item	Description
Position Detecting Method	Position displacement is detected from flux changes using a magneto and a magnetic sensor.
Stop Position	The rotor stops at a position where the centers of the magneto and the magnetic sensor head face each other. Adjustment is available within $\pm 2^\circ$ by the adjustment resistor.
Stop Position Repetition Error*	$\pm 0.2^\circ$ or less
Resisting Torque	Continuous rated torque / $\pm 0.1^\circ$ displacement†
Orientation Card	Code No.: ETC62102X.3
Magneto	Type: MG-1378BS, MG-1444S (MG1378BS is the standard.)
Magnetic Sensor	Type: FS-1378C, FS-200A (FS-1378C is the standard.)

* When the magneto is mounted on the circumference of a spindle of 120mm diameter. Mechanical error and interference by external magnetic field is not considered.

† Continuous rated torque may not be obtained depending on the gain setting.

Table 5.6 Magnetic Sensor

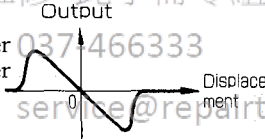
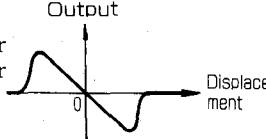
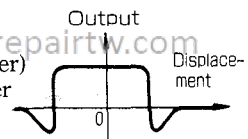
Item	Description	
	Type FS-1378C	Type FS-200A
Power Voltage	15 VDC $\pm 5\%$	12 VDC $\pm 10\%$
Current Consumption	100mA or less	50mA or less
Position Signal (for control) Level Offset Output impedance	$\pm 4V$ or greater $\pm 0.2V$ or lower 1.5k Ω 	$\pm 8V$ or greater $\pm 0.2V$ or lower 1.5k Ω 
Position Signal (for monitoring) Range Offset	30° or greater* (+2.4V or lower) $\pm 0.5V$ or lower 	
Operating Temperature	-10° to +50°C	
Output Terminals	Round connector (manufactured by Tajimi Radio Electric Appliances) A: Position signal + B: SG C: +15V D: Position signal - E: Range signal - F: Range signal + <p style="text-align: center;">†</p>	6mm dia. 4-core cable, 5m long <Wiring> Red: +12V Black: SG Green: Output + White: Output -
Manufacturer	Makome Laboratory	

* When the magneto is mounted on the circumference of a spindle of 120mm diameter.

† The range signals output from terminals E and F can be used for monitoring.

Table 5.7 Magneto Specifications

Item	Description	
	Type MG-1378BS	Type MG-1444S
Detection Range mm (inches)	± 15	± 7
Allowable Speed (r/min.) (Mounted on the circumference of 200mm diameter.)	6700	10,000
Mass (g)	33	15
Manufacturer	Makome Laboratory	

5.2.3 Dimensions in mm (in inches)

(1) Magnetic Sensor System Orientation Card (Type ETC 62102X.3)



Fig. 5.13 Dimensions of Orientation Card in mm (inches)

(2) Magneto

(a) Type MG-1378BS

(b) Type MG-1444S

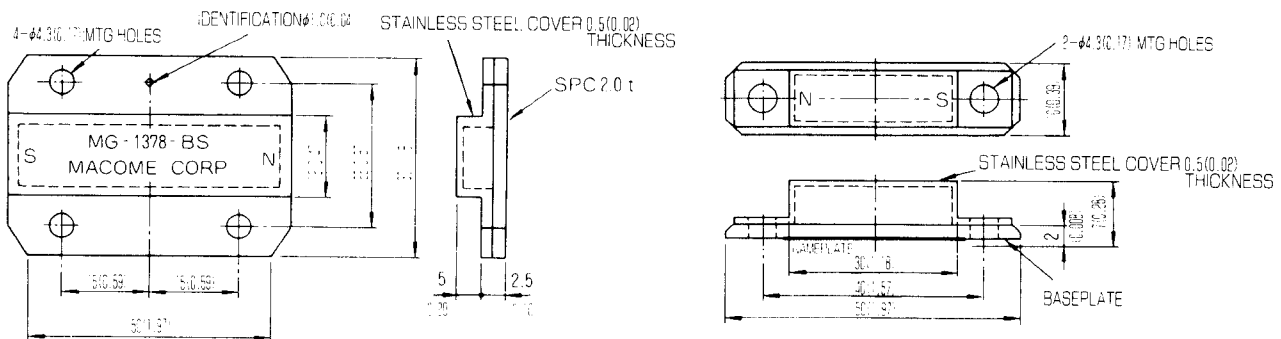
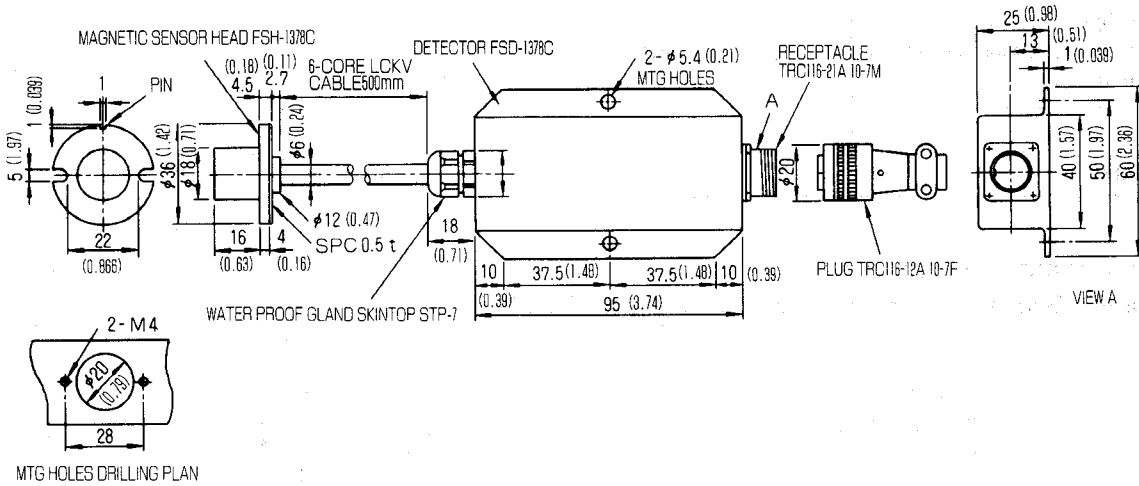

Fig. 5.14 Dimensions of Magneto in mm (inches)

(3) Magnetic Sensor
 (a) Type FS-1378C

MAGNETO MOTION DIRECTION



(b) Type FS-200A

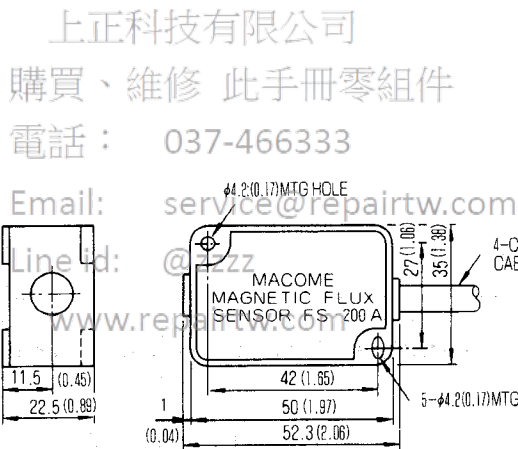
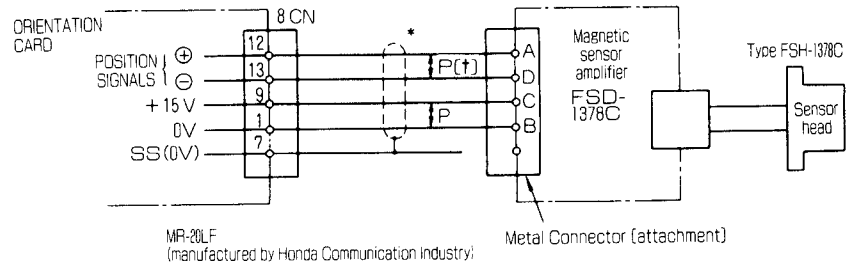

Fig. 5.15 Dimensions of Magnetic Sensor in mm (inches)

5.2.4 Connection

(1) Magnetic Sensor Signal



Note: Contact your YASKAWA representative on the other combinations of gear ratio.

* Use 0.3mm twisted pair 3P vinyl cable (copper-braided and shielded). Wiring extension must be 20 meters or shorter.

†  indicates twisted pair wires.

(a) Type FS-1378C

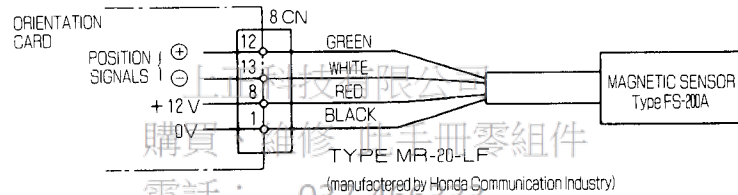

(b) Type FS-200A

Fig. 5.16 Connection of Magnetic Sensor

www.repairtw.com

5

5.2.5 Control Signal Connector Terminal Layout

20	19	18	17	16	15	14
—	—	—	—	—	—	—
	13	12	11	10	9	8
	SIG -	SIG +	—	—	+15V	+12V
7	6	5	4	3	2	1
SS (0V)	—	—	—	0 V	0 V	0 V

PBC Side : MR-20RMAG
 Cable Side : MR-20LF (G)
 or MR-20LWF (G)

- Notes: 1. The layout of pins is for the case where the connectors on the circuit board are viewed from the mating connector.
 2. In the diagram, the symbol \square represents an input signal and \square an output signal.

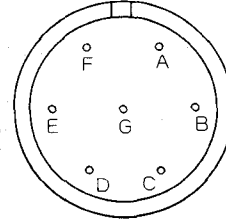

Magnetic Sensor Side : TRC116-21A10-7M
 Cable Side : TRC116-12A10-7F

- Notes: 1. The layout of pins is for the case where the connectors on the sensor are viewed from the mating connector.
 2. The connector to the cable belongs to the magnetic sensor.
 3. Connectors are made by Tajimi Radio Electric Co. Ltd.

(a) 8CN (Orientation Card Side) (b) Magnetic Sensor Side (FS-1378C)

Fig. 5.17 Connection Pin Location

5.2.6 Installing Magneto and Magnetic Sensor

The magneto is installed on the load axis, and the magnetic sensor is installed on a stationary part. Their relative position must be such that when the load axis is in the intended stop position, the magneto and the magnetic sensor are aligned center-to-center.

Fig. 5.18 shows the installing method, and Table 5.8 gives the required mounting accuracy.

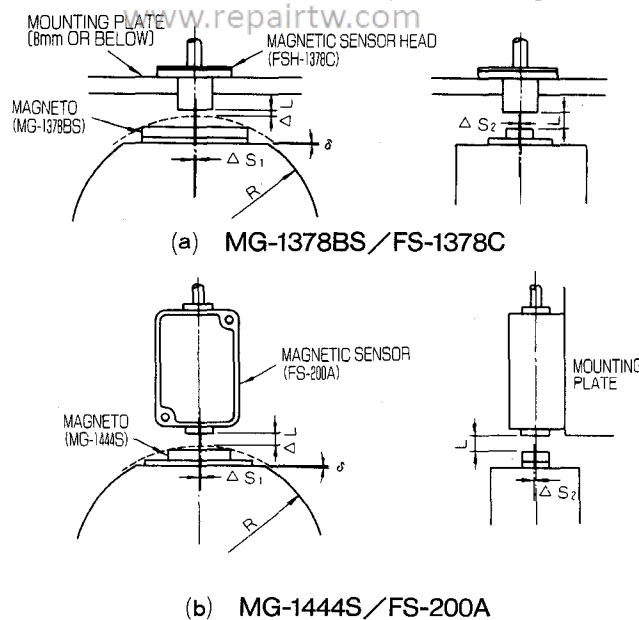

Fig. 5.18 Installing Magneto and Magnetic Sensor (1)

Table 5.8 Installing Magneto and Magnetic Sensor

Code	Dimensions	MG-1378BS / FSH-1378C	MG-1444S / FS-200A
R	Radius of spindle member*	60 to 70mm (2.36 to 2.76 inches)	60 to 70mm (2.36 to 2.76 inches)
L	Gap (center of magneto to magnetic sensor)†	6mm (0.24 inches) [6 to 8mm (0.24 to 0.31 inches)]	5mm (0.197 inches) [3 to 7mm (0.12 to 0.28 inches)]
ΔL	Gap (end of magneto to magnetic sensor)†	1 to 2mm (0.04 to 0.08 inches)	1 to 2mm (0.04 to 0.08 inches)
$\Delta S1, \Delta S2$	Center position error of magneto and magnetic sensor‡	0.5mm max (0.02 inches)	0.5mm max (0.02 inches)
δ	Angular displacement error from datum plane‡	0.2° max	0.2° max

* In determining the diameter of the spindle member for installing the magneto take permissible maximum centrifugal force of the magneto into consideration.

† The L value is a recommended value. Adjust the gap so as to satisfy the ΔL requirement.

‡ In aligning magneto to the mechanical center line of the system such as the spindle nose key of a machining center, observe the specified mounting accuracy standards for the center position and angular position of the magneto.

5.2.7 Notes on Mounting

- (1) The magneto's flux provides feedback for the position loop. Mount the magneto on the spindle (such as the spindle of a milling machine).
 - ★— If there is any transmission such as belt or gear between the axis with magneto and the spindle, stop position of the spindle may vary because of belt slippage or gear backlash.
- (2) The magneto has to be mounted on non-magnetic materials. Avoid adhesion of iron filings on the magneto.
 - ★— If there is any magnetic substance near the magneto, the magnetic field is distorted and position detection impaired, and the rotor may fail to stop at the proper position.
- (3) Be careful not to damage the magneto and the magnetic sensor when mounting.
 - ★— The magneto rotates at high speeds. Slight damage may lead to an unpredictable malfunction. The magnetic sensor is precision equipment. If force is applied to cause of internal distortion, detection precision may be deteriorated.
- (4) Remove magnetic field generating equipment such as solenoids and magnets from around the magneto and the magnetic sensor.
 - ★— If there is any magnetic field generating equipment near the magneto, the magnetic field may be distorted and proper position detection cannot be executed, and the rotor may fail to stop at the proper position.

(5) Avoid oil or water splashes on the magnetic sensor amplifier and the connecting cables. If the sensor head is frequently exposed to oil or water splashes, use sealing materials to avoid oil and water entry into the bushing as shown in Fig. 5.19.

—★— If water or used oil enters into the magnetic sensor or connecting cables, insulation deteriorates over time and the detection signals may be distorted, causing unacceptable control variations.

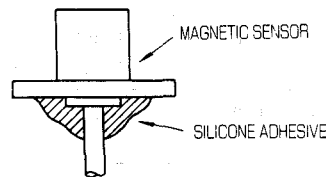
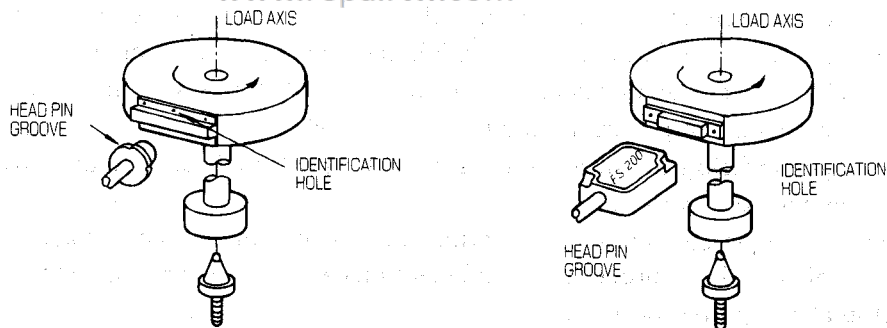

Fig. 5.19 Prevention of Liquid Entry into the Magnetic Sensor Bushing

(6) Cable length between the magnetic sensor amplifier and the orientation card must be 20 meters or shorter.

—★— Only a slight difference in voltage causes error detection signals of the magnetic sensor. Longer cables undergo more interferences by error voltage and noise voltage, leading to position errors.

(7) The magneto and the magnetic sensor must be mounted with the poles in proper position as shown in Fig. 5.20. If the polarity is reversed, however, control is possible by reversing the signals in the orientation card.



(a) Type MG-1378BS/FS-1378C

(b) Type MG-1444S/FS-200

Fig. 5.20 Magneto and Magnetic Sensor Mounting Direction

6. PREPARATION BEFORE STARTING

6.1 CHECK BEFORE TURNING ON POWER

After installation and wiring, check the following before turning ON power:

(1) Verify that capacity and type of the motor and the inverter match specifications of the load machine.

- Refer to the nameplates of the motor and the inverter.

(2) Check wiring between equipment with the connection diagram.

Do not activate the buzzer for checking when the control circuit is connected.

(3) Check for loose terminals and connectors.

- Main circuit screw terminals of the motor and the inverter.
- Fastening bolts at the motor and the inverter.

(4) Verify that the motor and the inverter are grounded sensor.

(5) Verify that signal line connectors are securely inserted in the specified places.

- Signal line connectors of the inverter, motor encoder, and magnetic sensor.

(6) Check that wire pieces and metal chips are not in the conducting parts.

(7) Verify that the motor and the load machine are ready to operate.

- Check for obstacles around the rotor.
- Verify that emergency stop and collision prevention function normally.

6.2 CHECKING POWER VOLTAGE

Turn OFF the molded-case circuit-breaker (MCCB) on the supply side of the inverter to verify the power input voltage supplied to the primary side of the MCCB. Use a voltmeter or rotation meter (volt-ammeter) to measure the input voltage. Table 6.1 shows allowable ranges of input voltage.

Table 6.1 Allowable Ranges of Power Voltage

Inverter	Nominal Voltage/ Frequency	Allowable Voltage Variation Range
200V Series	200V/50, 60 Hz	170 to 242 V
	220V/50, 60 Hz	
	230V/60 Hz	170 to 253 V

Note: VS-626VM3C is operational within the voltage variation range specified in the above table; however, the 200V series shows optimum characteristics at 200 to 240V. Thus, if supply voltage is lower than the basic 200V, specified output may not be obtained during high-speed operation. If input voltage can be varied by a changer, set the input voltage within the above ranges for optimum operation.

上正科技有限公司

購買、維修 此手冊零組件

電話： 037-466333

Email: service@repairtw.com

Line id: @zzzz

www.repairtw.com

7. OPERATION OF DIGITAL OPERATOR



This section explains the functions, operation method, and control constants of the digital operator. Become thoroughly familiar with the different procedures before turning power ON.

7.1 FUNCTIONS OF THE DIGITAL OPERATOR

VS-626VM3C supports the multi-functional display operator that enables the following:

(1) **Display of Control Signal Status**

Status of control signals of individual points is displayed by monitoring the status of operation. For the display items, refer to Table 7.3.

(2) **Display and Setup of Control Constants**

Control constants must be set up for normal operation in compliance with the specifications. Tables 7.4 to 7.6 list the control constants.

(3) **Display of Protective functions**

If an error occurs during operations, protective functions are displayed. Table 7.7 lists the protective functions. Nothing is displayed when operation is normal.

(4) **Operation by the Digital Operator**

By setting the control constant (C1-37), digital operator can be operated without sequence input signals or speed reference.

This function is valid only when test running inverter and motor.

Fig 7.1 shows the display unit and operation keys of the digital operator (JVOP-100).

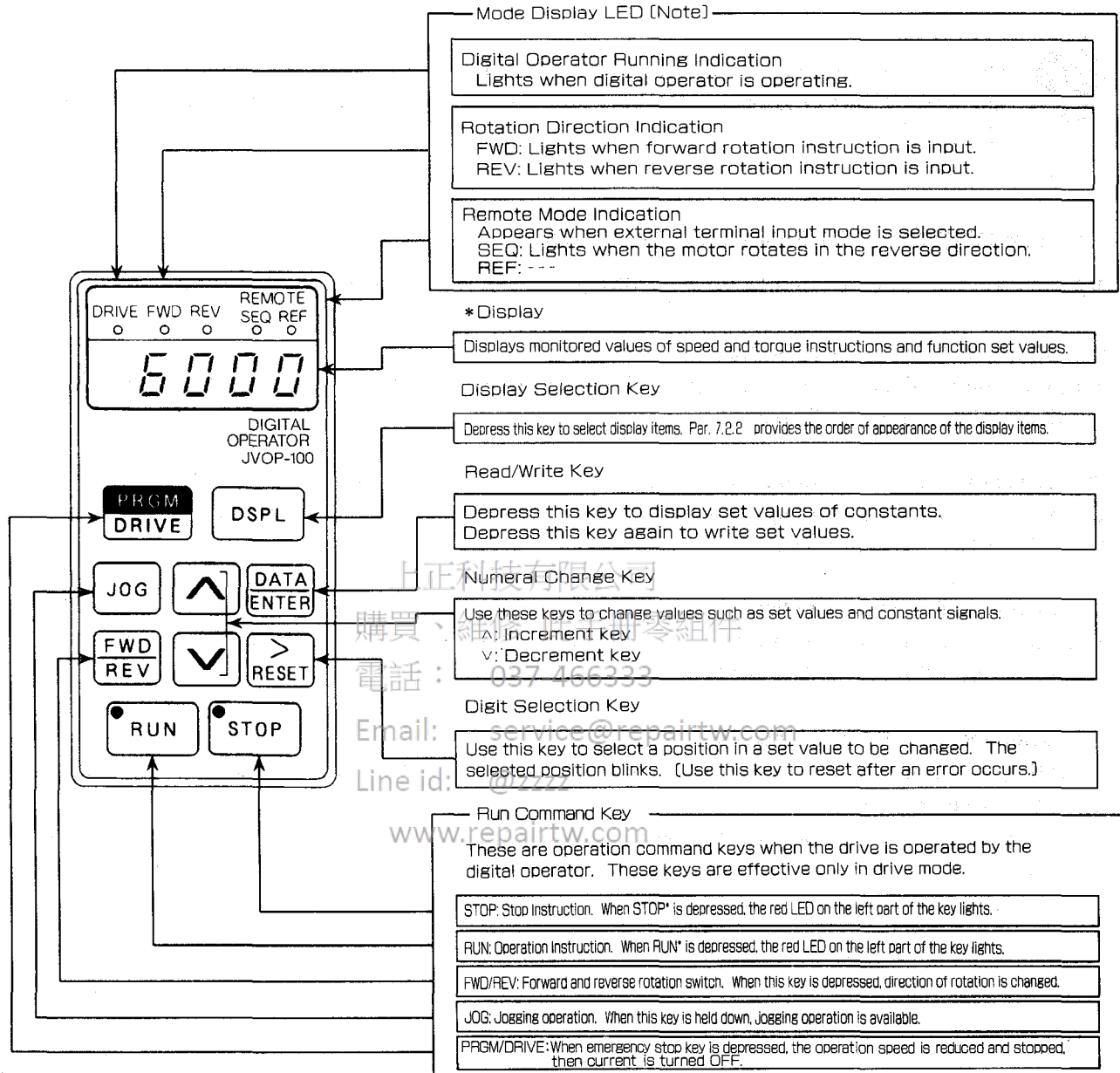

* Digital display LEDs and status display LEDs are used.

Fig. 7.1 Display Unit and Operation Keys of the Digital Operator (JVOP-100)

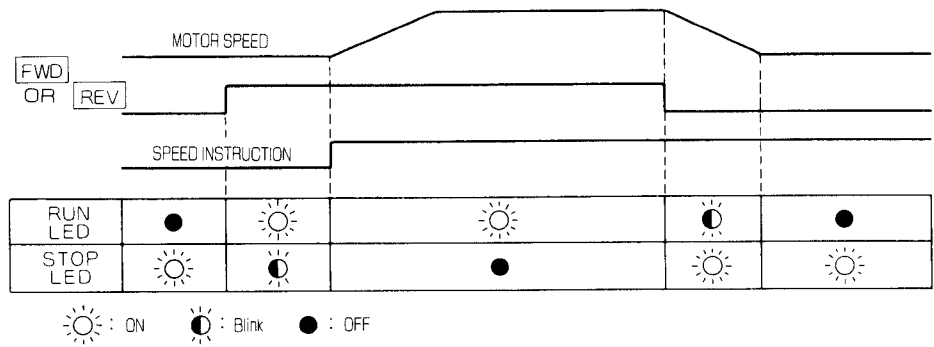

Note: RUN and STOP LEDs light, blink, and go OFF depending on the status of operation.

Fig. 7.2 Digital Operator Display

7.2 KEY OPERATIONS AND DISPLAY

Operations of the keys and indications of the digital operator are explained below. Table 7.1 corresponds displayed characters to alphanumeric characters.

Table 7.1 Indication of Numbers and Letters by 7-segment LED

No.	Letters
0	N
1	O
2	P
3	Q
4	R
5	S
6	T
7	U
8	V
9	W
.	X
-	Y
	Z

Note: “-” is not displayed.

7.2.1 Indication at Power-ON

When power is turned ON, all the LEDs of the digital operator light for LEDs selfcheck.



Then the PROM version is displayed. The upper five digits of the PROM number are displayed. The example is for PROM number "NSC 620020."



Finally, operation status data V1-01 (motor speed) is displayed. Since the motor is not rotating immediately after the power is turned ON, 0 is displayed. If a protective function is activated because of a failure, the failure indication number lights. The example indicates a break in a wire in the motor thermistor, which appears when the motor encoder signal connector (2CN) is disconnected.

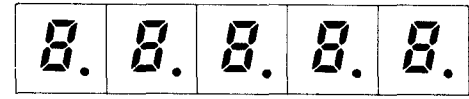

7.2.2 Switching Display Functions

Depress the **DSPL** key on the digital operator to change the mode of display. 正科技有限公司 購買、維修 此手冊零組件



電話： 037-466333

Depressing the **DSPL** key once changes the display from motor speed data to a data number. The first letter V indicates that operation status display mode has been selected. Email: service@repairtw.com Line id: @7777 www.repairtw.com



Depress the **DSPL** key again. Operation status display mode is changed to control constant display mode. In this mode, control constants can be set and changed.



Depress the **DSPL** key again. Usually, if no protective function is activated, operation status display mode is restored. If bits 0 or 1 of control constant C1-37 are set ON, instruction display mode of operation by the digital operator is entered.

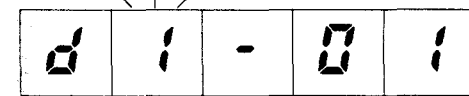
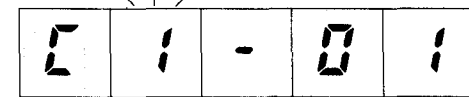

When the **DSPL** key is depressed in digital operator operation mode, operation status display mode is restored provided that no protective function has been activated.

If a protective function is activated because of a failure, the failure indication number lights.

The example indicates a break in a wire in the motor thermistor.

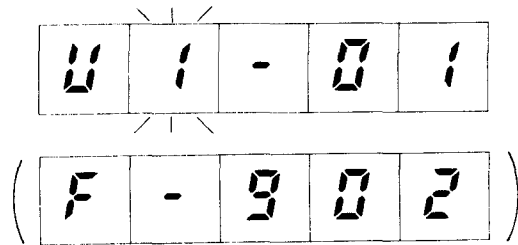

7.2.3 Operation Status Display Mode

To check data in operation status display mode, do as follows.

To change a data number, depress **>** key once.

The blinking cursor moves to the displayed data number. Depress **>** key again to return the blinking cursor to its initial position.

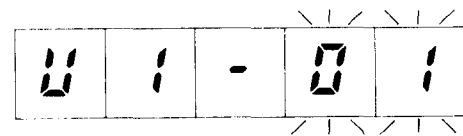

Search for the data number to be checked (in this example, V1-09) using **^** or **v** key.

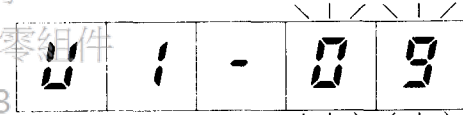

Depress the **DATA** key to change data number display to data contents display.

The display example is the status when **RDY** and **EMG** are closed.

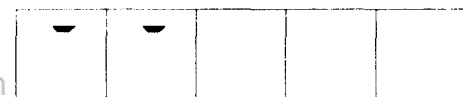

To return to data number display from data contents display, depress the **DSPL** key.

For explanations of operation status display, see Table 7.3.

立昇科技有限公司
 購買、維修 此手冊零組件
 電話：037-466333
 mail: service@repairtw.com
 Line id: @zzzz
 www.repairtw.com

7.2.4 Control Constant Display Mode

To check data or set or change a constant in control constant display mode, do as follows.

To change a data number, depress $\boxed{\triangleright}$ key once. The blinking cursor moves to the displayed data number. Depress $\boxed{\triangleright}$ key again to return the blinking cursor to its initial position.



Search for the data number to be checked (in this example, C1-10) using $\boxed{\wedge}$ or $\boxed{\vee}$ key.



Depress the $\boxed{\text{DATA}}$ key to change data number display to data contents display.



Select the position in the data to be changed and depress $\boxed{\triangleright}$ key to move the blinking cursor.



Use $\boxed{\wedge}$ or $\boxed{\vee}$ key to change the data. (In this case, from "1" to "5")



Hold down the $\boxed{\text{DATA}}$ key for several seconds. The entire data blinks for several seconds, then stops blinking. The data has been changed. (The entire data continuously blinks if the data is out of the setting range. If this occurs, depress the $\boxed{\text{DSPL}}$ key to change from data contents display to data number display, then restart setting from the beginning.)



To return to data contents display from data number display, depress the $\boxed{\text{DSPL}}$ key.

For explanations of control constants, see Tables 7.4 to 7.6.

Note: C1-01 to 24, C2-01 to 08, C3-01 to 08 can be changed during operation or stop. C1-25 to 40, C2-09 to 24, C3-09 to 24 can be changed only during stop.

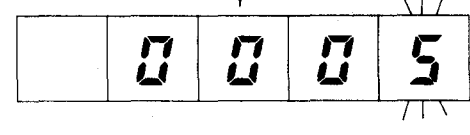
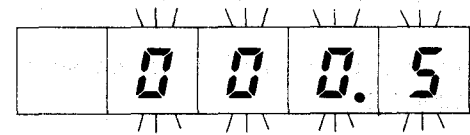
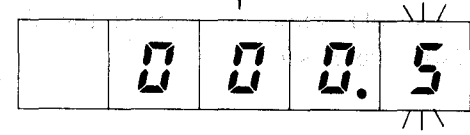
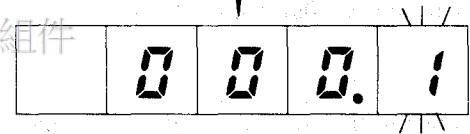
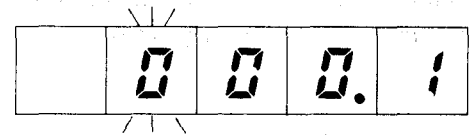
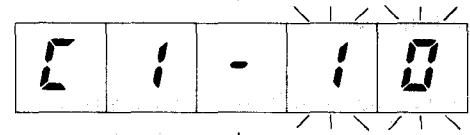
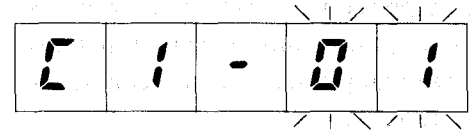

7.2.5 Digital Operator Operation Mode

To operate by the digital operator, do as follows.

Select C1-37 in control constant display mode.





Depress the **DATA** key to change from data number display to data contents display.



Select the position in the data to be changed and depress **>** key to move the blinking cursor. Set the lower two bits ON.

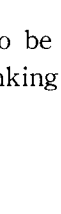

Use **^** or **v** key to change the data. (In this case, the lower two bits are changed from "11" to "11")

Operation step ( , **^** ,  , **>** , )



Hold down the **DATA** key for several seconds. The entire data blinks for several seconds, then stops blinking. The data has been changed.



Depress the **DSPL** key to return to data number display from data contents display. Digital operator operation mode is entered.



Then set up for speed instructions.

Depress the **DSPL** key to select "instruction constant" for digital operator operation. Use cursor keys **>**, **^**, or **v** to set a speed instruction for d1-02. Speed instruction is expressed as a percent of the rated speed setting (C1-26). If 25% is set when rated speed is 6000 r/min., the instruction translates into 1500r/min.



For operation, stop, and forward-reverse run, use the **RUN**, **STOP**, and **FWD/REV** keys respectively on the digital operator. Display on the digital operator changes each time the **DSPL** key is depressed from constants (C1-01, and so on) to variables (V1-01, . . .) to instructions (d1-01, . . .). Operation control signals and speed instructions displayed among instruction display are handled similar to constant setup. Table 7.2 lists the parameters.

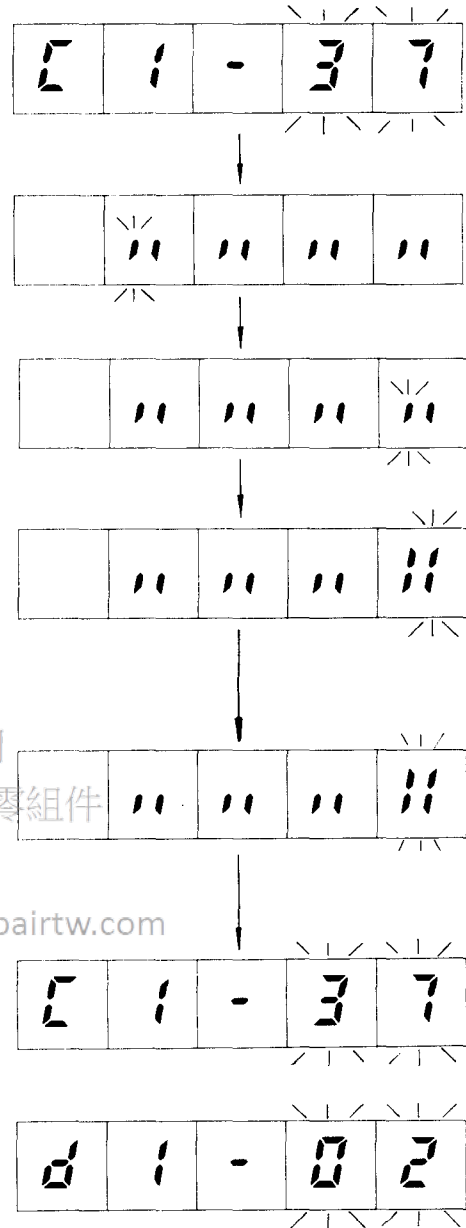

To return from digital operator operation mode to normal operation by external instructions, change the lower two bits of C1-37 from “11” to “11”

Table 7.2 Parameters for Digital Operator Operations

Constant No.	Description	Unit	Initial Value in Digital Operator Operation
d1-01	Sequence input	Binary	
d1-02	Speed reference	%	Percentage display to rated speed setting (C1-26)

7.2.6 Protective Function Operation Display Mode

If a protective function is activated because of a failure, the protective function indication number is displayed. After an error is reset, up to four protective operations are recorded to view the order of a series of failures.

First protective function operation is indicated with an F followed by a hyphen.

Depress key to display the protect display number which activated the next protective function.

If key is depressed when the last failure display number is displayed, the first failure display number is displayed again. Depress key to display failure display numbers in reverse order of occurrence.

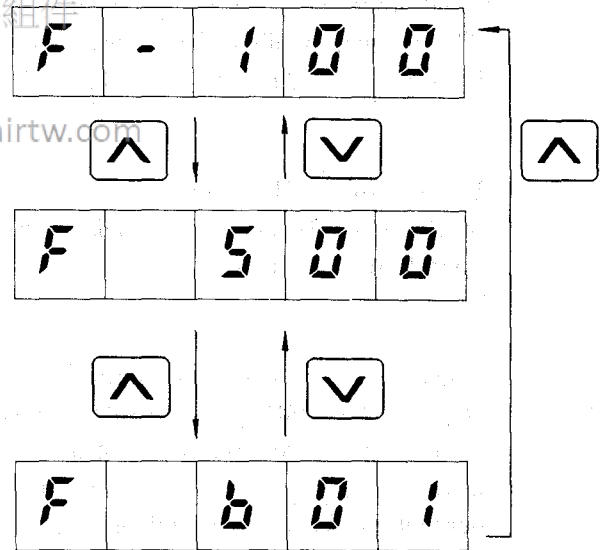

NOTE

To reset a failure by the digital operator after removing the cause, depress the **RESET** key in protective function operation display mode. In other modes, the **RESET** key cannot reset the failure. Before resetting, turn OFF **FWD**, **REV**, and **ORT**.

7.3 OPERATION STATUS DISPLAY FUNCTION

Different groups of operation status indications are displayed for different modes of operation. V1 indications are for inverter operation. V2 indications are for optional encoder orientation control. V3 indications are for magnetic sensor orientation control, which is also optional. (Data marked with * are operation status display data for preset.)

Table 7.3 (a) Operation Status Display Functions (For Inverter Operation)

No.	Signal Name	Description	Unit
V1-01	Motor Speed	Speed detected by the motor encoder	r/min
V1-02	Speed Reference	Speed control reference. Ratio of analog instruction to the rated speed.	%
V1-03	Load Axis Speed	Product of motor speed and gear transmission ratio	r/min
V1-04	Torque Reference	Percentage to 15-minute rating (100%)	%
V1-05	-----		
V1-06	Inverter Output Current	Detected inverter output current converted to amperes. Precision is $\pm 3\%$	A
V1-07	Output Frequency	Inverter current output frequency	Hz
*V1-08	Internal Status	Operation status signal (at logical level)	
V1-09	Input Signal Status	Sequence input signal ON/OFF status †	
V1-10	Output Signal Status	Sequence output signal ON/OFF status †	
V1-11	Inverter Capacity	Inverter unit 15-minute rated capacity	kW
V1-12	-----		
V1-13	-----		
*V1-14	DC Bus Voltage	Main circuit capacitor voltage. Precision is $\pm 3\%$	V
V1-15	Analog Speed Instruction AD Converted Value	Converted value of analog instruction to be used for speed instruction offset adjustment. Valid only during operation.	
*V1-16	-----		
*V1-17	Phase-U current	Detected phase-U current converted from analog to digital	
*V1-18	Phase-W current	Detected phase-W current converted from analog to digital	
V1-19	PROM No.	Displays the PROM soft version No. (lower 5 digits) Example: 20020 (NSC 620020)	

Table 7.3 (b) List of Operation Status Display Functions (For Encoder Orientation Control)

No.	Signal Name	Description	Unit
V2-01	I/O Signal Status	Orientation I/O signal status †	
V2-02	-----		
V2-03	Position Monitor	Actual position expressed by dividing one rotation by 4096 in reference to a set origin	Pulses
V2-04	Commanded Stop Position	Commanded stop position expressed by dividing one rotation by 4096 in reference to a set origin	Pulses
V2-05	Position Deviation	Difference between commanded stop position and current position in pulses	Pulses
V2-06	Positioning Time	Time from input of orientation instruction to output of completion signal	$\times 2\text{ms}$

Table 7.3 (c) List of Operation Status Display Functions
(For Magnetic Sensor Orientation Control)

No.	Signal Name	Description	Unit
V3-01	I/O Signal Status	Orientation I/O signal status †	
V3-02	Magnetic Sensor Signal Level	—	
V3-03	Position Monitor	Actual position expressed in reference to a set origin	Pulses
V3-04	Commanded Stop Position	Commanded stop position expressed in reference to a set origin	Pulses
V3-05	Position Deviation	Difference between commanded stop position and current position in pulses	Pulses
V3-06	Positioning Time	Time from input of orientation instruction to output of completion signal	×2ms

Table 7.3 (d) List of Operation Status Display Functions (Others)

No.	Signal Name	Description	Unit
V7-01	Motor Temperature	Detected temperature for motor overheat protection	°C
*V7-02	Slip Frequency	Slip frequency to be applied to the motor	Hz

† Status of I/O signals are shown in the following lamps of input signals in the ON status light.

電話： 037-466333

Email: service@repairtw.com

Line id: @zzzz

www.repairtw.com

<V1-09> Sequence Input Signal Status Display

EMG	RDY	FWD	REV	LGR
SSC	TLIM		ORT	RST

<V1-10> Sequence Output Signal Status Display

SDET	AGR	ZSPD		TLE
ORG	ORE		FLT	

<V2-01> I/O Signal Status for Encoder Orientation Control Display

HGR		LGR		ORESTS
TUNE				

上海科有限公司
 購買、維修 此手冊零組件
 電話： 037-466333
 Email: service@repairtw.com

<V3-01> I/O Signal Status for Magnetic Sensor Orientation Control Display

HGR		LGR		ORESTS
TUNE				

www.repairtw.com

7.4 CONTROL CONSTANTS

Different groups of control constants are displayed for different modes of operation. User constants (C1) are for inverter operation. C2 constants are for optional encoder orientation control. C3 constants are for magnetic sensor orientation control, which is also optional.

NOTE The following constants cannot be changed during running :
C1-25 to 40, C2-9 to 24, C3-09 to 24
Change the constants after stopping the motor.

Table 7.4 User Constant List

Constant No.	Constant Name	Description	Unit	Upper Limit	Lower Limit
C1-01	Speed Control Proportional Gain (H) K_{VHN}	Speed control proportional gain when high-speed gear is selected (LGR is OFF). Raising K_{VHN} increases rigidity. Torque Instruction $P = K_{VHN} \times \text{Speed Tolerance}$	% / Hz	255	1
C1-02	Speed Control Integral Time Constant (H) τ_{VHN}	Speed control integral time constant when high-speed gear is selected (LGR is OFF). Reducing τ_{VHN} quickens response. Torque Instruction $I = \text{Speed tolerance} \times \text{Time} / \tau_{VHN}$	ms	1000	5
C1-03	Speed Control Proportional Gain (L) K_{VLN}	Speed control proportional gain when low-speed gear is selected (LGR is ON). Raising K_{VLN} increases rigidity. Torque Instruction $P = K_{VLN} \times \text{Speed Tolerance}$	% / Hz	255	1
C1-04	Speed Control Integral Time Constant (L) τ_{VLT}	Speed control integral time constant when low-speed gear is selected (LGR is ON). Reducing τ_{VLT} quickens response. Torque Instruction $I = \text{Speed Tolerance} \times \text{Time} / \tau_{VLT}$	ms	1000	5
C1-05	Speed Control Proportional Gain (H) K_{VHS}	Speed control proportional gain when high-speed gear is selected (LGR is OFF) in servo mode (SV is ON). Torque Instruction $P = K_{VHS} \times \text{Speed Tolerance}$	% / Hz	255	1
C1-06	Speed Control Integral Time Constant (H) τ_{VHS}	Speed control integral time constant when high-speed gear is selected (MGR and LGR are OFF) or when high-speed winding is selected (CHW is OFF) in servo mode (SSC is ON). Torque Instruction $I = \text{Speed Tolerance} \times \text{Time} / \tau_{VHS}$	ms	1000	5
C1-07	Speed Control Proportional Gain (L) K_{VLS}	Speed control proportional gain when low-speed gear is selected (LGR is ON) in servo mode (SV is ON). Torque Instruction $P = K_{VLS} \times \text{Speed Tolerance}$	% / Hz	255	1
C1-08	Speed Control Integral Time Constant (L) τ_{VLS}	Speed control integral time constant when low-speed gear is selected (LGR is ON) in servo mode (SV is ON). Torque Instruction $I_N = \text{Speed Tolerance} \times \text{Time} / \tau_{VLS}$	ms	1000	5
C1-09	Torque Instruction Filter Time Constant τ_T	Time constant of low-pass filter of torque instructions to be used in measures against gear chattering noise. Increasing the time constant may cause run-away depending on conditions.	ms	5.0	0.0
C1-10	Soft Start Time T_{SFS}	Setting of required time for soft starter. Variations in speed instructions are suppressed according to the speed change ratio of the set time. Starting time from at rest state is obtained as follows: Starting Time = $T_{SFS} \times \text{Speed Instruction} (\%) / 100$	s	180.0	0.1

Table 7.4 User Constant List (Cont'd)

Constant No.	Constant Name	Description	Unit	Upper Limit	Lower Limit
C1-11	Speed Instruction Offset Adjustment Value SC_{OFS}	Offset adjustment value for analog speed instructions. Set the values of V1-15 when operating at speed instruction 0 for C1-11.		80	-80
C1-12	Motor Speed Adjustment Value S_{ADJ}	Constant for fine control of motor speed when analog speed instructions are used. Speed is increased in proportion to S_{ADJ} . This parameter is invalid when digital speed instructions are used.		1.1000	0.9000
*C1-13	-----	-----			
C1-14	-----	-----			
*C1-15	-----	-----			
C1-16	Speedometer Signal Adjustment Value SM_{ADJ}	Constant for fine control of speedometer signal to match the actual and indicated speeds. Increasing SM_{ADJ} makes the speedometer indicator travel farther. Standard value is 10V output at the maximum speed.		1.50	0.90
C1-17	Load Ratio Meter Signal Adjustment Value LM_{ADJ}	Constant for fine control to match the commanded torque and indication on the load ratio meter. Increasing LM_{ADJ} makes the meter indicator travel farther. Standard value is 10V output at 120% of the 15-minute rating.		1.50	0.90
C1-18	Load Ratio Meter Full-scale LN_{FS}	Setting of full-scale value of the load ratio meter expressed as a percent of continuous rating. Note that the full-scale value depends on specifications of the load machine.	%	350	120
C1-19	Zero-speed Detection Level ZS_{LVL}	Detection level of zero-speed signal (ZSPD). Standard setting is 30 r/min.	r/min	60	3
C1-20	Speed-match Signal Detection Width AGR_{BD}	Detection width of speed-match signal at rated speed. Standard setting is 15%.	%	50	10
C1-21	Speed Detection Signal Level SD_{LVL}	Speed detection signal (SDET) activation level. Expressed as a percent of the motor rated speed.	%	100	0
C1-22	Speed Detection Signal Detection Signal Width SD_{HYS}	Hysteresis width adjustment level of speed signal detection. During acceleration, $SD_{LVL} + SD_{HYS}$ is detected. During deceleration, $SD_{LVL} - SD_{HYS}$ is detected. Expressed as a percent of the motor rated speed.	%	10.00	0.00
C1-23	-----				
C1-24	External Control Torque Limiting Level TL_{EXT}	Torque limit using external torque limiting signals (TLIM). Expressed as a percent of the 15-minute rated torque.	%	120	5
C1-25	Motor Code Selection MTR	Select applicable motor from the motor codes stored in inverter memory. Expressed in 2-digit hexadecimals 0 to F. Available after selecting the code and turning power ON again.		FF	01
C1-26	Rated Speed Setting S_{100}	Rated speed set according to load machine specifications. Must not be greater than the motor maximum speed. When commanded speed is 100%, this speed is applied.	r/min	Max. Speed	100
C1-27	Transmission Ratio 1 R_{HGR}	Transmission ratio determined by mechanical specifications. This parameter is valid when H gear (LGR is OFF) is selected. Transmission Ratio = Spindle speed ÷ Motor Speed		2.5000	0.0500
C1-28	-----				

7

Table 7.4 User Constant List (Cont'd)

Constant No.	Constant Name	Description	Unit	Upper Limit	Lower Limit
C1-29	Transmission Ratio 3 (L) R_{LGR}	Transmission ratio determined by mechanical specifications. This parameter is valid when L gear (LGR is ON) is selected. Transmission Ratio = Load Shaft Speed ÷ Motor Speed		2.5000	
					0.0500
C1-30	Motor Flux Lower Limit Level ϕ_{WL}	Level limit motor flux reduction control lower.	%	100	
					15
C1-31	Servo Mode Flux Level ϕ_{SVH}	Motor flux level in servo mode (SV in ON).	%	100	
					30
C1-32	Servo Mode Basic Speed Ratio R_{BSH}	Base speed ratio in servo mode (SV in ON). Base Speed (Servo) = $R_{BSL} \times$ Base Speed (Motor)		5.00	
					1.00
C1-33	-----				
C1-34	-----				
C1-35	Zero-speed Brake Time T_{BLK}	Time for generating braking force after deceleration and zero-speed is reached to stop.	s	100	
					0
C1-36	Select Signal 1 SEL1*	Setting signal for multi-functional selection. For further description, see Par.4.1, "SEQUENCE INPUT SIGNALS." • Bits 1 and 0 : 1CN, pin 41 00 : TLIM 01 : -- 10 : INC 11 : -- • Bit3: 1CN, pin 40 0 : SSC 1 : SV		---	

C1-37	Select Signal 2 SEL2*	Setting signal for multi-functional selection. For further description, see Par.4.1 "SEQUENCE INPUT SIGNALS." Bits 1 and 0: Operation by speed instructions 00: Operation by speed instructions 11: Operation by the digital operator Bits 3 and 2: Preparation for operation signal selection 00: Free run by current interruption 01: After deceleration stop, interrupts current and MC is OFF. 10: After deceleration stop, interrupts current and MC is ON.		---	

Table 7.4 User Constant List (Cont'd)

Constant No.	Constant Name	Description	Unit	Upper Limit
				Lower Limit
C1-38	Select Signal 3 SEL3*	<p>Select signal for control mode and level.</p> <ul style="list-style-type: none"> • Bits 1 and 0: Load ratio meter filter <ul style="list-style-type: none"> 00: 2ms filter 01: 10ms filter 10: 100ms filter 11: 500ms filter • Bit 2: Torque limiting auto judgement <ul style="list-style-type: none"> 0: Not judged 1: Judged • Bit 3: Servo mode sensitivity <ul style="list-style-type: none"> 0: reference (10V/100%) 1: reference (10V/5000r/min) • Bit 4: Speed over-deviation protective (F800) operation threshold <ul style="list-style-type: none"> 0: 1/2 or less of commanded speed 1: 1/4 or less of commanded speed • Bit 5: Speed limiting level <ul style="list-style-type: none"> 0: 105% of rating instruction 1: 110% of rating instruction • Bit 6: Speed agreed signal output select at zero-speed <ul style="list-style-type: none"> 0: Outputs (AGR is close) 1: Does not output (AGR is open) • Bit 7: Load ratio meter adjustment method <ul style="list-style-type: none"> 0: Outputs 120% signal of 15-minute rating 1: Outputs 100% signal of continuous rating 		---
C-39	Select Signal 4 SEL 4*	<p>Control mode select signal</p> <ul style="list-style-type: none"> • Bit 0: Orientation method <ul style="list-style-type: none"> 0: Encoder 1: Magnetic sensor 		---
C1-40	Select Signal 5 SEL 5*	<p>Control mode select signal</p> <ul style="list-style-type: none"> • Bits 1 and 0: Speed over-deviation protective (F800) operation delay time select <ul style="list-style-type: none"> 00: 0 sec 01: 0.3sec 10: 0.4sec 11: 0.5sec • Bit 3: NC orientation selection <ul style="list-style-type: none"> 0: Invalid 1: Valid <p>Even if orientation signal (ORT) is input, Orientation operation does not start. The rotation direction of the motor is decided depending on the polarity of analog speed reference.</p> • Bit 7: Load error detection selection (Correspond to PROM version or atter NSC620042.) <ul style="list-style-type: none"> 0: Invalid 1: Valid 		---

* In explanation of select signals, 0 stands for “ 0 ” and 1 for “ 1 ”

Table 7.5 Encoder Orientation Constants

Constant No.	Constant Name	Description	Unit	Upper Limit
				Lower Limit
C2-01	Load Axis Positioning Origin P_{ORG}	Mechanical origin of the load axis. Set difference from encoder origin signal (phase-C) pulses.	Pulses	4095
				0
C2-02	Position Control Proportional Gain (H) K_{PH}	Position control proportional gain when high-speed gear is selected (LGR is OFF). Raising K_{PH} increases rigidity. Speed Reference (pps) = $K_{PH} \times$ Position Tolerance (pulses)	1/s	99
				1
C2-03	---			
C2-04	Position Control Proportional Gain (L) K_{PL}	Position control proportional gain when low-speed gear is selected (LGR is ON). Raising K_{PL} increases rigidity. Speed Reference (pps) $K_{PL} \times$ Position Tolerance (pulses)	1/s	99
				1
C2-05	Speed Control Proportional Gain (H) K_{VHO}	Speed control proportional gain when high-speed gear is selected (LGR is OFF) in orientation control (ORT is ON). Torque Reference $P = K_{VHO} \times$ Speed Tolerance	% / Hz	255
				1
02-06	Speed Control Integral Time Constant (H) τ_{VHO}	Speed control integral time constant when high-speed gear is selected (LGR is OFF) in orientation control (ORT is ON). Torque Reference $I =$ Speed Tolerance \times Time / τ_{VHO}	ms	1000
				5
C2-07	Speed Control Proportional Gain (M, L) K_{VLO}	Speed control proportional gain when low-speed gear is selected (LGR is ON) in orientation control (ORT is ON). Torque Reference $P = K_{VLO} \times$ Speed Tolerance	% / Hz	255
				1
C2-08	Speed Control Integral Time Constant (L) τ_{VLO}	Speed control integral time constant when low-speed gear is selected (LGR is ON) in orientation control (ORT is ON). Torque Reference $I =$ Speed Tolerance \times Time / τ_{VLO}	ms	1000
				5
C2-09	Positioning Completion Detection Width Z_{FIN}	Detection width for outputting completion signal when the spindle reaches near the commanded stop position. Detection width is commanded stop position $\pm Z_{FIN}$	Pulses	200
				0
C2-10	Positioning Completion Cancel Width Z_{CAN}	Set value for canceling completion signal when the spindle is moved after completion signal is output. Cancel width is commanded stop position $\pm Z_{CAN}$	Pulses	200
				Z_{FIN}
C2-11	Orientation Speed S_{ORT}	Speed applied (after detecting encoder origin) until changing to the servo loop during orientation	r / min	600
				40
C2-12	BCD Stop Position Instruction Resolution P_{BCD}	Angle set value per minimum increment of stop position BCD instructions		180.0
				0.5
C2-13	Arbitrary Stop Position Offset P_{IMG}	Stop position offset for smoothing stop operation when the servo loop is used. When Z_{FIN} is reached, offset becomes 0.	Pulses	100
				0

Table 7.5 Encoder Orientation Constants (Cont'd)

Constant No.	Constant Name	Description	Unit	Upper Limit	Lower Limit
C2-14	Orientation Speed Change Ratio R_{SOR}	Speed change ratio for gradually reducing orientation speed to reduce gear noise when switching from orientation speed to servo loop speed		100	
					0
C2-15	Starting Soft Start Time T_{SFO}	Soft start time for accelerating from at rest state to orientation speed. Use this parameter to reduce gear noise at starting Acceleration rate is (500 r/min.)/s.	ms	50	
					0
C2-16	Flux Level ϕ_{ORT}	Flux level at completion of orientation. Motor noise and torque changes in proportion to flux level.		100	
					15
C2-17	Orientation Speed Reduction Coefficient K_{SOR}	Reduction coefficient to set orientation speed in proportion to the angle of traveling for incremental positioning.		32767	
					0
C2-18	---				
C2-19	---				
C2-20	---				
C2-21	---				
C2-22	Orientation Control Select Signal 1 SEL-E1*	<p>Control mode setting signal for specifying the direction of rotation in orientation control</p> <ul style="list-style-type: none"> • Bits 1 and 0: Positioning rotation direction <ul style="list-style-type: none"> 00: Automatically selected rotation direction 01: Same direction as the commanded operation direction 10: Fixed rotation direction 11: Automatically selected rotation direction • Bit 2: Selection for fixed rotation direction <ul style="list-style-type: none"> 0: Forward rotation of the spindle 1: Reverse rotation of the spindle • Bit 3: Stop position instruction code <ul style="list-style-type: none"> 0: 12-bit binary 1: 3-digit BCD • Bit 4: Tune-up operation <ul style="list-style-type: none"> 0: Tune-up available 1: Tune-up unavailable • Bit 6: Encoder <ul style="list-style-type: none"> 0: Spindle encoder 1: Motor encoder • Bit 7: Rotation direction of motor and spindle (Automatically setting when tune-up) <ul style="list-style-type: none"> 0: Reverse 1: The same 			---

* In explanation of select signals, 0 stands for “ 0 ” and 1 for “ 1 ”.

Table 7.5 Encoder Orientation Constants (Cont'd)

Constant No.	Constant Name	Description	Unit	Upper Limit																		
				Lower Limit																		
C2-23	Orientation Control Select Signal 2 SEL-E2*	<p>Dither signal pattern and gain</p> <ul style="list-style-type: none"> • Bit 0: DB selection upon orientation completion <ul style="list-style-type: none"> 0: Invalid 1: Stops by braking torque orientation completion • Bit 1: Dither signal pattern <ul style="list-style-type: none"> 0: 6 steps (83Hz) 1: 2 steps (250Hz) • Bits 4, 3, and 2: Dither signal level (H) <table border="0"> <tr> <td>000 : 0.0%</td> <td>011 : 7.5%</td> <td>110 : 15.0%</td> </tr> <tr> <td>001 : 2.5%</td> <td>100 : 10.0%</td> <td>111 : 17.5%</td> </tr> <tr> <td>010 : 5.0%</td> <td>101 : 12.5%</td> <td></td> </tr> </table> • Bits 7, 6, and 5: Dither signal level (L) <table border="0"> <tr> <td>000 : 0%</td> <td>011 : 3%</td> <td>110 : 6%</td> </tr> <tr> <td>001 : 1%</td> <td>100 : 4%</td> <td>111 : 7%</td> </tr> <tr> <td>010 : 2%</td> <td>101 : 5%</td> <td></td> </tr> </table> 	000 : 0.0%	011 : 7.5%	110 : 15.0%	001 : 2.5%	100 : 10.0%	111 : 17.5%	010 : 5.0%	101 : 12.5%		000 : 0%	011 : 3%	110 : 6%	001 : 1%	100 : 4%	111 : 7%	010 : 2%	101 : 5%			---
000 : 0.0%	011 : 7.5%	110 : 15.0%																				
001 : 2.5%	100 : 10.0%	111 : 17.5%																				
010 : 5.0%	101 : 12.5%																					
000 : 0%	011 : 3%	110 : 6%																				
001 : 1%	100 : 4%	111 : 7%																				
010 : 2%	101 : 5%																					
C2-24	Orientation Control Select Signal 3 SEL-E3*	<p>Orientation Control parameters</p> <ul style="list-style-type: none"> • Bits 5 and 4: Speed instruction differential compensation gain <table border="0"> <tr> <td>00 : 10</td> </tr> <tr> <td>01 : 15</td> </tr> <tr> <td>10 : 23</td> </tr> <tr> <td>11 : 34</td> </tr> </table> • Bits 7 and 6: Flux level for positioning servo loop control <table border="0"> <tr> <td>00 : 100%</td> </tr> <tr> <td>01 : 80%</td> </tr> <tr> <td>10 : 60%</td> </tr> <tr> <td>11 : 40%</td> </tr> </table> 	00 : 10	01 : 15	10 : 23	11 : 34	00 : 100%	01 : 80%	10 : 60%	11 : 40%		---										
00 : 10																						
01 : 15																						
10 : 23																						
11 : 34																						
00 : 100%																						
01 : 80%																						
10 : 60%																						
11 : 40%																						

*In expansion of select signals, 0 stands for “0” and 1 for “1.”

Table 7.6 Magnetic Sensor Orientation Constants

Constant No.	Constant Name	Description	Unit	Upper Limit	Lower Limit
C3-01	Load Axis Positioning Origin P_{ORG}	Mechanical origin of the load axis. Set difference from magnetic sensor signal in degrees.	°	2.00	-2.00
C3-02	Position Control Proportional Gain (H) K_{PH}	Position control proportional gain when high-speed gear is selected (LGR is OFF). Boosting K_{PH} increases rigidity. Speed Reference (pps) = $K_{PH} \times$ Position Tolerance (pulses)	1/s	99	1
C3-03	---				
C3-04	Position Control Proportional Gain (L) K_{PL}	Position control proportional gain when low-speed gear is selected (LGR is ON). Boosting K_{PL} increases rigidity. Speed Reference (pps) = $K_{PL} \times$ Position Tolerance (pulses)	1/s	99	1
C3-05	Speed Control Proportional Gain (H) K_{VHO}	Speed control proportional gain when high-speed gear is selected (LGR is OFF) in orientation control (ORT is ON). Torque Reference $P = K_{VHO} \times$ Speed Tolerance	%/Hz	255	1
C3-06	Speed Control Integral Time Constant (H) τ_{VHO}	Speed control integral time constant when high-speed gear is selected (LGR is OFF) in orientation control (ORT is ON). Torque Reference $I =$ Speed Tolerance \times time / τ_{VHO}	ms	1000	5
C3-07	Speed Control Proportional Gain (L) K_{VLO}	Speed control proportional gain when low-speed gear is selected (LGR is ON) in orientation control (ORT is ON). Torque Reference $P = K_{VLO} \times$ Speed Tolerance	%/Hz	255	1
C3-08	Speed Control Integral Time Constant (L) τ_{VLO}	Speed control integral time constant when low-speed gear is selected (LGR is ON) in orientation control (ORT is ON). Torque Reference = Speed Tolerance \times time / τ_{VLO}	ms	1000	5
C3-09	Positioning Completion Cancel Width Z_{FIN}	Detection width for outputting completion signal when the load axis reaches near the commanded stop position. Detection width is commanded stop position $\pm Z_{FIN}$	°	20.0	0.0
C3-10	Positioning Completion Detection Width Z_{CAN}	Set value for canceling completion signal when the load axis is moved after completion signal is output. Cancel width is commanded at stop position $\pm Z_{CAN}$	°	20.0	Z_{FIN}
C3-11	Orientation Speed S_{ORT}	Speed applied (after detecting magnetic sensor signal) until changing to the servo loop during orientation	r/min	600	40
C3-12	---				
C3-13	Arbitrary Stop Position Offset P_{IMG}	Stop position offset for smoothing stop operation when the servo loop is used When Z_{FIN} is reached, offset becomes 0.	°	10.0	0

7

Table 7.6 Magnetic Sensor Orientation Constants (Cont'd)

Constant No.	Constant Name	Description	Unit	Upper Limit	Lower Limit
C3-14	Orientation Speed Change Ratio	Speed change ratio for gradually reducing orientation speed to reduce gear noise when swiching from orientation speed to servo loop speed		100	
					0
C3-15	Starting Soft Start Time T_{SFO}	Soft start time for accelerating from stop to orientation speed. Use this parameter to reduce gear noise at starting. Acceleration rate is (500 r/min) /s.	ms	50	
					0
C3-16	Flux Level ϕ_{ORT}	Flux level at completion of orientation. Motor noise and torque change in propotion to flux level.		100	
					15
C3-17	----				
C3-18	----				
C3-19	----				
C3-20	Sensor Signal Standardization Angle θ_{CEN}	Angle for standardizing magnetic sensor signal detection sensitivity $\theta_{SEN} = 180^\circ \times \text{Detected Range (in mm)} \div (\text{Mounting Radius (in mm)} \times \pi)$ Set 20.0 to θ_{SEN} when $\theta_{SEN} > 20.0$ For detected range, check the magneto type and apply the following value. For type MG-1378BS, apply 15mm. For type MG-1444S, apply 7mm.		20.0	
					5.0
C3-21	----	Email: service@repairtw.com Line id: @zzzz			
C3-22	Orientation Control Select Signal 1 SEL-MI*	Control mode setting signal for specifying the direction of rotation in orientation control • Bits 1 and 0: Positioning rotation direction 00: Automatically selected rotation direction 01: Same direction as the commanded forward-reverse rotation direction 10: Fixed rotation direction 11: Automatically selected rotation direction • Bit 2 : Selection for fixed rotation direction 0 : Forward rotation of the spindle 1 : Reverse rotation of the spindle • Bit 4 : Tune-up operation 0 : Tune-up available 1 : Tune-up unavailable • Bit 6 : Encoder 0 : Spindle encoder 1 : Motor encoder • Bit 7 : Rotation direction of motor and spindle 0 : Reverse 1 : The same			----

Table 7.6 Magnetic Sensor Orientation Constants (Cont'd)

Constant No.	Constant Name	Description	Unit	Upper Limit
				Lower Limit
C3-23	Orientation Control Select Signal 2 SEL-M2*	<p>Dither signal pattern and gain</p> <ul style="list-style-type: none"> • Bit 1 : Dither signal pattern 0: 6 steps (83Hz) 1: 2 steps (250 Hz) • Bits 4, 3, and 2 : Dither signal level (H) 000 : 0.0% 011 : 7.5% 110 : 15.0% 001 : 2.5% 100 : 10.0% 111 : 17.5% 010 : 5.0% 101 : 12.5% • Bits 7, 6, and 5 : Dither signal level (L) 000 : 0% 011 : 3% 110 : 6% 001 : 1% 100 : 4% 111 : 7% 010 : 2% 101 : 5% 		---
C3-24	Orientation Control Select Signal 3 SEL-M3*	<p>Orientation control parameters</p> <ul style="list-style-type: none"> • Bits 5 and 4 : Speed instruction differential compensation gain 00 : 10 01 : 15 10 : 23 11 : 34 • Bits 7 and 6 : Flux level for positioning servo loop control 00 : 100% 01 : 80% 10 : 60% 11 : 40% <p>上正科技(上海)有限公司 購買、維修、手冊零組件 電話： 037-466333 Email: service@repairtw.com Line id: @zzzz www.repairtw.com</p>		---

* In explanation of select signals, 0 stands for “0” and 1 for “1”.

7.5 PROTECTIVE FUNCTION DISPLAY

If an error occurs during operation, protective functions are activated depending on the failure and operation is stopped. The activated protective functions are indicated on the digital operator in F codes as shown in Table 7.7.

Table 7.7 Protective Functions

F Code No.	Protective Function	Explanation	
F-001	Emergency Stop Failure	Operation was not stopped within 10 seconds after emergency stop was commanded.	
F-100	Inverter Output Overcurrent	Output current exceeded set overcurrent value or grounding.	
F-200	Inverter Internal MC Operation Failure	The magnetic contactor in the input block is not functioning.	
F-301	Braking Transistor Error	Braking transistor operation failure	
F-302	Cooling Fan Error	Inverter cooling fan stops when power is ON.	
F-400	Inverter Overvoltage	Inverter DC bus voltage exceeded set overvoltage value (approx. 400v).	
F-500	Motor Overspeed	Motor speed exceeded 120% of max. set speed.	
F-602	Power Voltage Error 1	Dc main circuit voltage is lowered to 210V or less.	
F-604	Power Voltage Error 2	DC control circuit voltage was lowered.	
F-700	Inverter Output Overload	Output current of 120% of 15-minute rating flowed for one minute or longer.	
F-800	Excess Speed Deviation	Speed dropped to 50% or lower. (Except during accel/decel)	
F-900	Motor Thermal Error 1	Motor temperature exceeded upper limit.(Minor failure)	
F-901	Motor Thermal Error 2	Motor temperature over upper limit continued for one minute or longer.	
F-902	Motor Thermal Error 3	Break in wire occurred in the motor temperature detection thermistor.(Detected at -10°C or less)	
F-904	Heat Sink Thermal Error	Heat sink temperature over upper limit.	
F-A00	Initial Charge Failure 1	Charging for the main capacitor did not complete.	
F-A01	Blown Fuse	DC circuit fuse has blown.	
F-b00	Controller Failure 1	Failure of the speed instruction AD converter	
F-b01	Controller Failure 2	Failure of the AD converter with CPU	
F-b02	Controller Failure 3	Failure of the Phase-U current detection AD converter	
F-b03	Controller Failure 4	Failure of the Phase-W current detection AD converter	
F-C00	Break in Speed Detection Signal Cable	Break in wire or misconnection of the motor encoder signal cable	
F-C01	Load error	Braking in wire of inverter output(U,V,W)	
F-d00	Controller Failure 5	Memory (PROM) failure	
F-d01	Software Version Mismatch	Controller mismatched software version.	
F-d11	Position Detector Failure 1	Encoder Method	Phase-C signal was not detected when tuning up.
		Magnetic Sensor Method	Break in wire or misconnection of the magnetic sensor signal cable when tuning up.
F-d12	Position Detector Failure 2	Phase-C signal exceeded 100 pulses when tuning up.	
F-d13	Position Detector Failure 2	Encoder Method	Exceeds 4096 ± 1 pulses per rotation when tuning up.
		magnetic Sensor Method	Motor pulse per rotation (4096/gear ratio) exceeds $\pm 6\%$.

Table 7.7 Protective Functions (Cont'd)

F Code No.	Protective Function	Description
F-d14	Tune-up Incomplete	Orientation instruction was input before tuning up.
F-d15	INC Signal Error	Incremental signal timing error of INC signal
F-d16	Break in Position Detection Signal Cable	Break in wire or misconnection of the position detection encoder signal cable
F-d17	Break in Magnetic Sensor Signal Cable	Break in wire or misconnection of the magnetic sensor signal cable
F-d18	Orientation Card Mismatch	Orientation selection (bit 0 of C1-39) mismatched orientation card.
F-E00	Controller Failure 6	Memory (NVRAM) failure
F-E01	Controller Failure 7	Memory (NVRAM) failure
F-E02	Controller Failure 8	Data in memory (NVRAM) exceeded upper or lower limit.
F-E03	Controller Failure 9	Memory (NVRAM) failure
F-E05	Unregistered Motor Code	Motor code set to C1-25 do not register.
F-F00	I/O Error 1	Inter-CPU data transfer error
F-F03	I/O Error 2	Inter-CPU data transfer error
CPF00	CPU Failure 1	Internal memory (RAM) failure or WDT activation.
CPF01	CPU Failure 2	Excessive time error

上正科技有限公司
 購買、維修 此手冊零組件
 電話： 037-466333
 Email: service@repairtw.com
 Line id: @zzzz
 www.repairtw.com

上正科技有限公司

購買、維修 此手冊零組件

電話： 037-466333

Email: service@repairtw.com

Line id: @zzzz

www.repairtw.com

8. TEST RUN

Before turning power ON, do the following:

- (1) Verify there is no physical obstacle to operation.
- (2) Notify people in the adjacent area before starting.

Turn ON power to the drive system after confirming security around the machines.

8.1 CHECK AFTER TURNING ON POWER

After power is turned ON, LEDs on the digital operator of the inverter light and the cooling fans of the motor and the inverter start rotation. Check the system as follows:

8.1.1 Checking the Motor

Verify that cooling air for the motor with cooling fan flows in the direction shown in Fig 8.1.

According to the standard specifications, cooling air is taken in from the drive end and exhausted from the opposite drive end. If the flow direction is reversed, contact your YASKAWA representative.

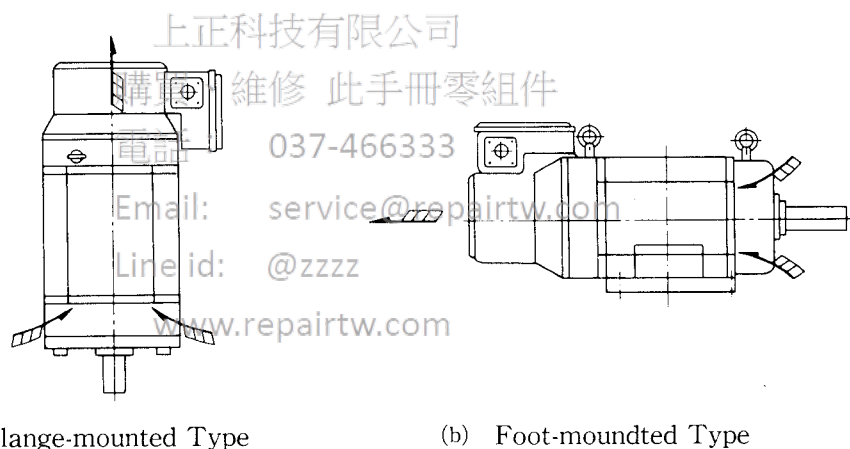

(a) Flange-mounted Type

(b) Foot-mounted Type

Fig 8.1 Motor Cooling Air Passage

8.1.2 Checking the Inverter

After power is turned ON, all the LEDs on the digital operator light, then ROM number is displayed, and finally motor speed (V1-01) is displayed as described in Par.7.2.1, "Indication at Power-ON."

If emergency stop signal (EMG) is connected, "CHARGE" lights brightly in red. If error indication is displayed or "CHARGE" is OFF, investigate the cause according to Par. 10, "TROUBLE-SHOOTING".

8.1.3. Checking Status Display

Status of the drive system including the inverter and the motor can be checked by monitoring the contents of V1-01 to V1-18 using the operation status display function.

After power is turned ON, motor speed (V1-01) is displayed. Check other status indications with Table 8.1.

Table 8.1 Status Monitoring Functions

Signal No.	Content	Unit	Display at Power ON	Remarks
V1-01	Motor speed	r/min	0	
V1-02	Speed reference	%	0.00	100% = rated speed
V1-03	Output shaft speed	r/min	0	
V1-04	Torque reference	%	0.0	100% =15-minute rating
V1-05	Inverter output power	kW	0.0	Accuracy: ± 10%
V1-06	Inverter input current	A	0.0	Effective value, accuracy: ±3%
V1-07	Inverter output frequency	Hz	0.0	
V1-08	Inside signal condition		----- ----- -----	
V1-09	Input signal condition		----- ----- -----	
V1-10	Output signal condition		----- ----- -----	
V1-11	Inverter capacity	kW	Depends on unit	
V7-01	Motor temperature	°C	Ambient temperature	At cold start

Note: The digital operator display unit employs 7-segment LEDs. Status of operation is indicated by "V" plus a number, meaning a variable number. Actual display, however, looks like "V" plus a number. (Example: V1-01-V1-01) For the detail of display, refer to Par. 7.1, "FUNCTIONS OF THE DIGITAL OPERATOR"

上正科技有限公司
 購買、維修 此手冊零組件
 電話： 037-466333
 Email: service@repairtw.com
 Line id: @zzzz
 www.repairtw.com

8.2 SETTING UP CONSTANTS

The inverter is set up and adjusted at the factory to fit the combined motor. As a rule, customers do not need to adjust the inverter. If setting must be modified because of changes of operation specifications, control constants can be changed. See Par. 7, "OPERATION OF THE DIGITAL OPERATOR" and change the setting.

In the following, control constants are explained in the order of arrangement; however they do not need to be set up in that order.

8.2.1 Soft Start Time Setup (T_{SFS} : C1-10)

This constant specifies the duration of changing inverter speed from 0r/min. to the rated speed or vice versa. Fig. 8.2 shows the relation between instructions and the duration. Soft start time can be set up from 0.1 to 180.0 seconds.

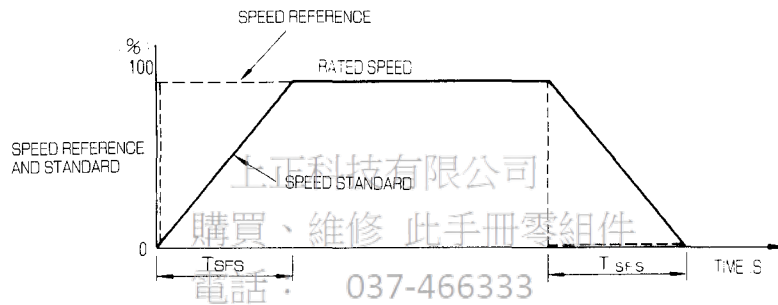

Fig. 8.2 Soft Start Time Setting

8.2.2 Load Meter Full-scale (LM_{FS} : C1-18)

During operation, the load ratio meter indicates the ratio of output to motor rated output in percent. Set full-scale value (expressed as a percent of the motor continuous rating) of the load meter for control constant C1-18. 120% to 350% can be set.

8.2.3 Zero-speed Detection Level (ZS_{LVL} : C1-19)

This constant sets the detection level for zero-speed signal. Standard value is 30 r/min. It is possible to set 3 r/min. to 60 r/min. The operating point has a hysteresis of ± 2 r/min. as shown in Fig. 8.3.

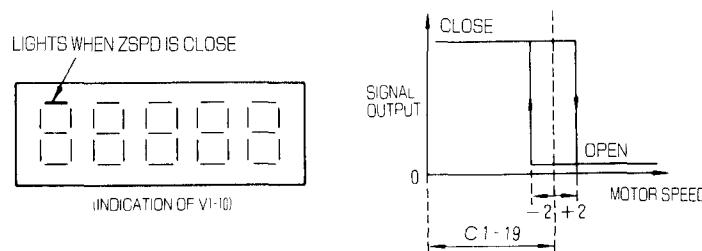

Fig. 8.3 Zero-speed Signal Detection Level and Operation Indication

8.2.4 Speed Agreed Width (AGR_{BD}: C1-20)

This constant sets the operating level for speed agreed signal AGR (connected when speeds agree). Range of speed agree can be set from 10% to 50%. Standard value is 15%.

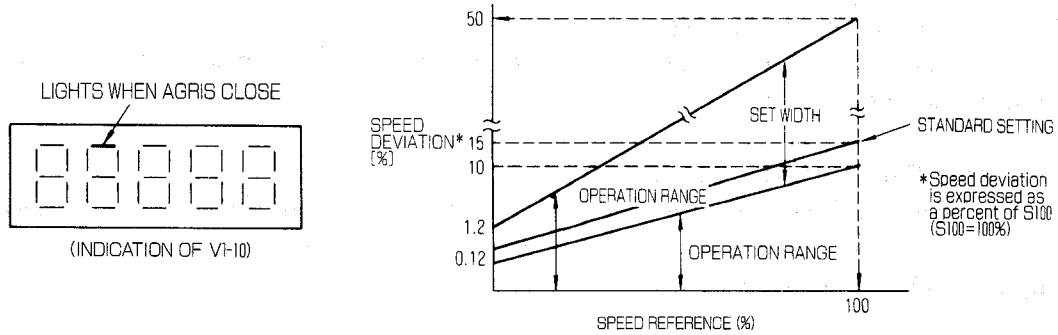

Fig.8.4 Speed Agreed Width Setting and Operation Indication

8.2.5 Speed Detection Level (SD_{LVL}:C1-21, SD_{HYS}: C1-22)

If motor speed is reduced to or below any of these constants, output signal SDET is connected.

Fig.8.5 shows indication of operation status display V1-10 of the digital operator then.

Speed detection level can be set from 0% to 100%. Hysteresis width can be set from 0% to 10%.

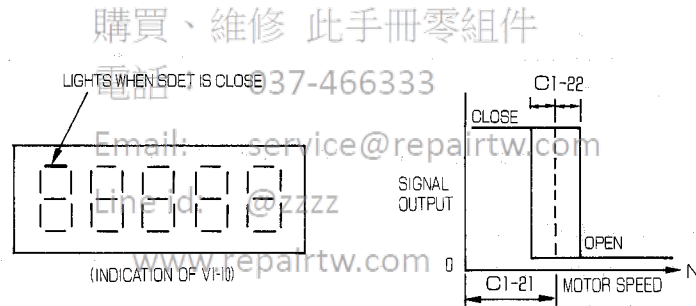

Fig. 8.5 Speed Detection Level and Operation Indication

8.2.6 External Operation Torque Limiting Level (TL_{EXT}: C1-24)

This control constant is used for external torque limiting. The constant is expressed as a percent of 15-minute rated torque and can be set from 5% to 120%.

8.2.7 Motor Code Selection (MTR: C1-25)

The motor code is a label of the motor control constant stored in the inverter memory. Motor codes are given in the factory setting list attached to the inverter. Before altering the set motor code, verify that the inverter unit capacity is matched.



After changing the motor code, turn OFF power and verify that the indications on the digital operator go OFF, then turn ON power again.

Without the above procedure, changed motor code is invalid.

8.2.8 Rated Speed (S₁₀₀: C1-26)

Set up rated speed according to mechanical specifications. The motor runs at the rated speed when speed instruction of 100% is input.

Rated speed can be set from 100 r/min to the motor maximum speed.

8.2.9 Transmission Ratio (R_{HGR}: C1-27, R_{LGR}: C1-29)

These constants set the transmission ratio of spindle to motor shaft which is determined by mechanical specifications.

Transmission ratio (spindle speed/motor speed) can be set from 0.05 to 2.5. When you set an exact value, the ratio affects the orientation control characteristics.

上正科技有限公司
購買、維修、此手冊零組件
電話: 037-466333
Email: service@repairtw.com
Line id: @zzzz
www.repairtw.com

8.2.10 Flux and Base Speed Ratio in Servo Mode (ϕ_{SVH} : C1-31, R_{BSH} : C1-32)

These control constants are used to extend constant torque control range for solid tapping. Set the flux levels (C1-31) and the base speed ratios (C1-32) in relation to each other as shown in Fig.8.6.

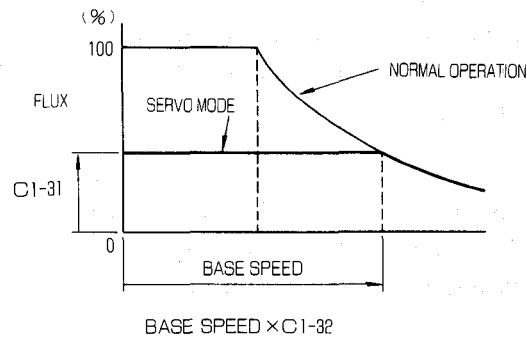

Fig. 8.6 Flux Level in Servo Mode

8.2.11 Positioning Completion Detection Width (Z_{FIN} : C2-09, C3-09) and Positioning Completion Cancel Width (Z_{CAN} : C2-10, C3-10)

These constants must be set up while the system is stopped.

Orientation completion signal is connected when the difference between the commanded and actual stop positions is within the completion detection width continuously for 10 ms or longer. If the difference exceeds the completion cancel width after the completion signal is output, the completion signal is immediately disconnected.

Both completion detection width and completion cancel width can be set from 0 (0°C) to 200 (17.6°) in encoder orientation control, and from 0.0° to 20.0° in magnetic sensor orientation control. Completion cancel width must not be smaller than completion detection width. If a value greater than completion cancel width is set for completion detection width after setting the cancel width, the completion detection width value is automatically set for the cancel width.

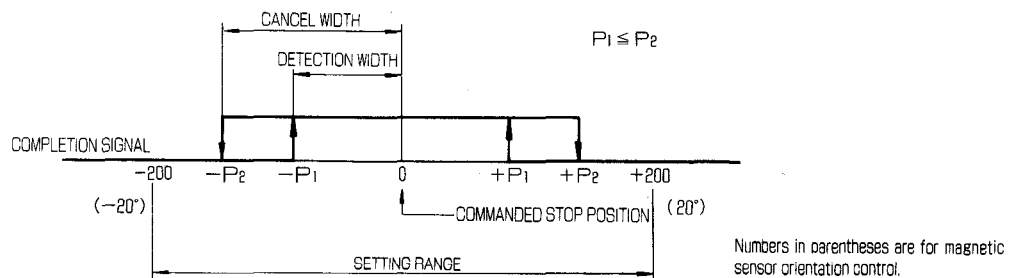

Fig. 8.7 Completion Signal Detection Position

8.2.12 Orientation Speed (S_{ORT}: C2-11, C3-11)

Orientation speed must be set up while the system is stopped.

Orientation speed is determined by inertial momentum (including motor shaft) and torque. Calculate for each machine the spindle inertial momentum and the spindle torque required when high-speed gear is used, then obtain orientation speed from Fig. 8.8. The value is the upper limit, so lower setting is possible.

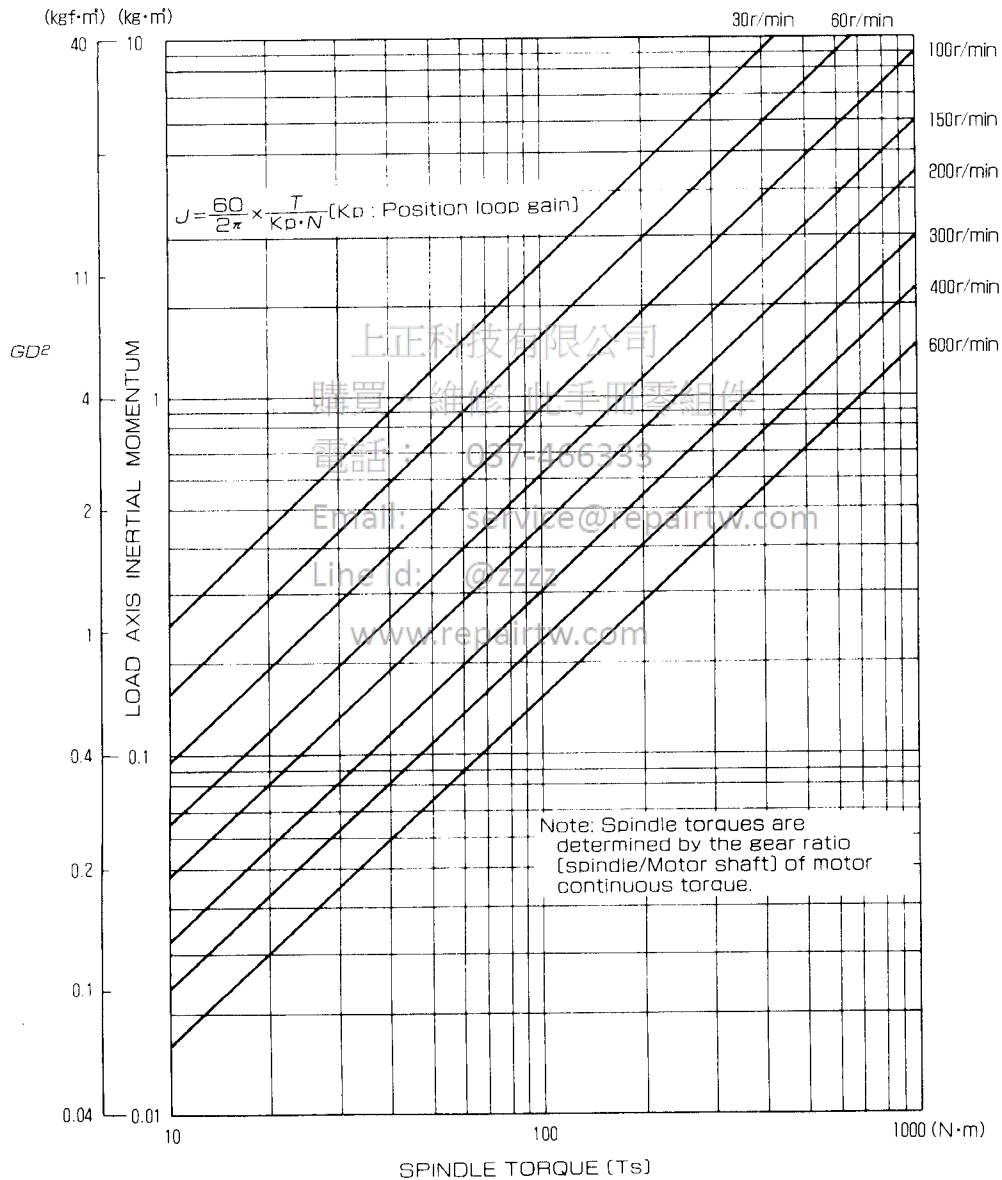

Fig. 8.8. Orientation Speed Setting

8.2.13 Resolution of BCD Stop Position Instructions (P_{BCD}:C2-12)

This setting must be performed while the system is stopped.

The resolution can be set from 0.5° to 180.0°. Stop position instruction must be within ±360°.

For example, when resolution is set to 90°, stop position instruction “1” translates into 90°, “2” into 180°, “4” into 0°, and “5” again into 90°.

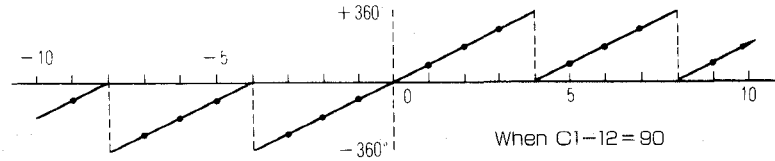

Fig. 8.9 Stop Position Instruction and Stop Position

8.3 OPERATION

After checking, input operation signal to start operation. Gradually raise speed reference from 0%. The motor starts rotation.

Verify that the motor turns in the proper direction. When forward run is commanded (by FWD) and speed instruction is positive, the motor shaft turns counterclockwise (CCW) when viewed from the load machine. If the rotation direction is reversed, or if the motor does not turn but only buzzes or vibrates after the operation signal is input, phases of the power cable or encoder signal wire may be connected wrong. Turn OFF power and check wiring.

When the motor turns in the proper direction, change speed reference or switch forward and reverse run and verify that acceleration and deceleration are smooth in both forward and reverse directions. At the same time, check for excessive motor vibration or noise. Stationary sound at several kilohertz is due to the control method and do not indicate any abnormality.

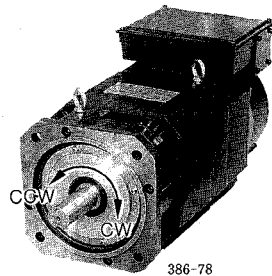

Speed Reference		⊕	⊖
Operation Signal	FWD	CCW	CW
	REV	CW	CCW

Fig. 8.10 Motor Rotation Direction

NOTE

- (1) Verify that the motor stands still before starting. Starting during free-run may activate overvoltage protection (F400) or overcurrent protection (F100).
- (2) Don't change wiring or put on/off connectors under the current conduction.

8.4 ADJUSTMENT PROCEDURE AND CONTROL CONSTANT SETUP

After verifying that the motor operates normally, adjust the speed control mode and position control mode for orientation control according to the adjustment procedures. The following adjustment must also be performed after replacing the motor, inverter, magnetic sensor or encoder.

8.4.1 Adjustment in Speed Control Mode

Refer to the following flow chart for adjustment.

Adjusting Item and Procedure	Content
<pre> graph TD A[Turn ON power switch] --> B[Initial setting] B --> C[Turn emergency stop (EMG) and operation ready (RDY)] C --> D[Input rated speed reference] D --> E[Turn forward run (FWD) ON] E --> F[After accelerations completed, check motor speed in V1-01] F --> G{Is the actual motor speed the same as the instruction?} G -- YES --> H((①)) G -- NO --> I{Is the actual motor speed higher than the reference?} I -- YES --> J[Make C1-12 (Sref) smaller than present value.] I -- NO --> K[Make C1-12 (Sref) greater than present value.] J --> G K --> G </pre>	<p>Initial setting: Verify the setting according to the factory setting.</p> <p>Operation control (with 0-V common)</p> <p>Input signal check Input signal status (V1-09)</p> <p>RDY, EMG, and FWD light.</p> <p>Speed reference adjustment range (C1-12)</p> <p>C1-12 = Commanded Motor Speed / Actual Speed</p> <p><Example> When 6000r/min is commanded and actual speed is 6060 r/min, $C1-12 = 6000/6060 = 0.99$</p>

Adjusting Item and Procedure	Content																
<p>①</p>	<p>Speedometer Adjustment Range (CI-16)</p> <p>CI-16 = actual motor speed / indication on speedometer <Example> When motor speed is 6000 r/min and indication on the speedometer is 5940 r/min. $CI-16 = 6000 / 5940 = 1.01$</p> <p>Maximum Indication on the Load Meter (12% of 15-minute rating)</p> <table border="1"> <caption>Maximum Indication on the Load Meter</caption> <thead> <tr> <th>Capacity</th> <th>LM</th> <th>Capacity</th> <th>LM</th> </tr> </thead> <tbody> <tr> <td>0.4 / 0.2</td> <td>240%</td> <td>2.2 / 1.5</td> <td>176%</td> </tr> <tr> <td>0.75 / 0.4</td> <td>225%</td> <td>3.7 / 2.2</td> <td>202%</td> </tr> <tr> <td>1.5 / 0.75</td> <td>240%</td> <td>5.5 / 3.7</td> <td>178%</td> </tr> </tbody> </table> <p>Signal Output for Load Meter adjustment</p> <p>* Signal of 100% of continuous rating is output when bit CI-38 is changed to "1".</p> <p>Load Meter Adjustment Range (CI-17)</p> <p>CI-17 = (120% of 15-minute rating) / indication on the load meter <Example> When capacity is 3.7 kW / 2.2 kW and indication on the load meter is 190%. $CI-17 = 202 / 190 = 1.06$</p>	Capacity	LM	Capacity	LM	0.4 / 0.2	240%	2.2 / 1.5	176%	0.75 / 0.4	225%	3.7 / 2.2	202%	1.5 / 0.75	240%	5.5 / 3.7	178%
Capacity	LM	Capacity	LM														
0.4 / 0.2	240%	2.2 / 1.5	176%														
0.75 / 0.4	225%	3.7 / 2.2	202%														
1.5 / 0.75	240%	5.5 / 3.7	178%														

8.4.2 Adjustment in Encoder Orientation Control Mode

Adjust the system according to the flow chart below.



Adjusting Item and Procedure	Content
<pre> graph TD A[Turn ON power switch.] --> B[Initial settings.] B --> C{Setting of gear ratio correct?} C -- NO --> D[Correct controller gear ratio and constant.] D --> C C -- YES --> E[Select H-gear.] E --> F[Turn orientation signal (ORT) ON.] F --> G[Tune-up incomplete error 'F-014' is displayed.] G --> H[Depress the [STOP] and [RESET] keys simultaneously.] H --> I{Turn the motor in forward and reverse directions to return the spindle to the home position. Did the axis stop at the home position?} I -- NO --> J[Adjust according to troubleshooting method.] I -- YES --> K[Select control constant display of spindle positioning origin (C2-01).] K --> L[Set positioning origin data, then depress the [ENTER] key.] L --> M[The spindle stops at the new origin.] M --> N{Is stop position correct?} N -- NO --> J N -- YES --> O((1)) </pre>	<p>Initial setting: Changing constants with the digital operator</p> <ul style="list-style-type: none"> Set orientation selection (bit 0) of selection signal 4 (C1-39) to "1". Set tune-up operation selection (bit 4) of orientation select signal (C2-22) to "1". <p>Gear ratio constant</p> <ul style="list-style-type: none"> C1-27.....H-gear ratio C1-29.....L-gear ratio <p>0.050 to 2.500</p> <ul style="list-style-type: none"> When gear ratio was selected, the changed constant is effective with turning off and on the power. <p>Identifying input signal</p> <ul style="list-style-type: none"> Interface input status (V1-09) <p>Tune-up operation</p> <p>Note: Orientation completion signal (ORE) is not output at tune-up operation.</p> <p>Spindle positioning origin</p>

(Cont'd)

Adjusting Item and Procedure	Content
<pre>graph TD Start((1)) --> A[Turn orientation signal (ORT) OFF.] A --> B[Turn-up completed.] B --> C[Adjust control constants depending on mechanical specifications.] C --> D[Turn orientation signal (ORT) ON.] D --> E{Does it stop smoothly?} E -- NO --> F[Adjust arbitrary stop position offset (C2-13)] F --> D E -- YES --> G{Is positional accuracy insufficient or is hunting condition present?} G -- YES --> H[Adjust position control proportional gain (C2-12)] H --> D G -- NO --> I[Turn orientation signal (ORT) OFF.] I --> J[Select L-gear.] J --> K[Turn orientation signal ON.] K --> L{Is positional accuracy insufficient or is hunting condition present?} L -- YES --> M[Adjust position control proportional gain (C2-04)] M --> K L -- NO --> N[Turn orientation signal (ORT) OFF.] N --> O[End of adjustment]</pre>	<ul style="list-style-type: none">• In case of abnormality during tune-up, carry out tune-up operations once again, after resetting. Set tune-up operation selection (C2-22, bit 4) to "1". <p>Adjusting control constant Adjustment of arbitrary stop position offset (C2-13)</p> <ul style="list-style-type: none">• Adjust so that the final positioning is not too long or overshoots. <p>• Identify the characteristics from H- and L-gear, because the characteristics vary with load inertia.</p> <p>Selection of H-gear Adjusting proportional gain (C2-02)</p> <ul style="list-style-type: none">• If ORE is not output in the region near the stop position, increase the gain.• If the spindle is unstable even if ORE is output, reduce the gain. <p>Note: If L-gear selection is not covered by equipment specifications, omit adjustment.</p> <p>Identifying selection of L-gear • Interface input state (V1-09)</p> <p>Lights when L-gear is selected.</p> <p>Adjusting proportional gain (C2-04)</p> <ul style="list-style-type: none">• If ORE is not output in the region near the stop position, increase the gain.• If the spindle is unstable even if ORE is output, reduce the gain.

8.4.3. Adjustment in Magnetic Sensor Orientation Control Mode

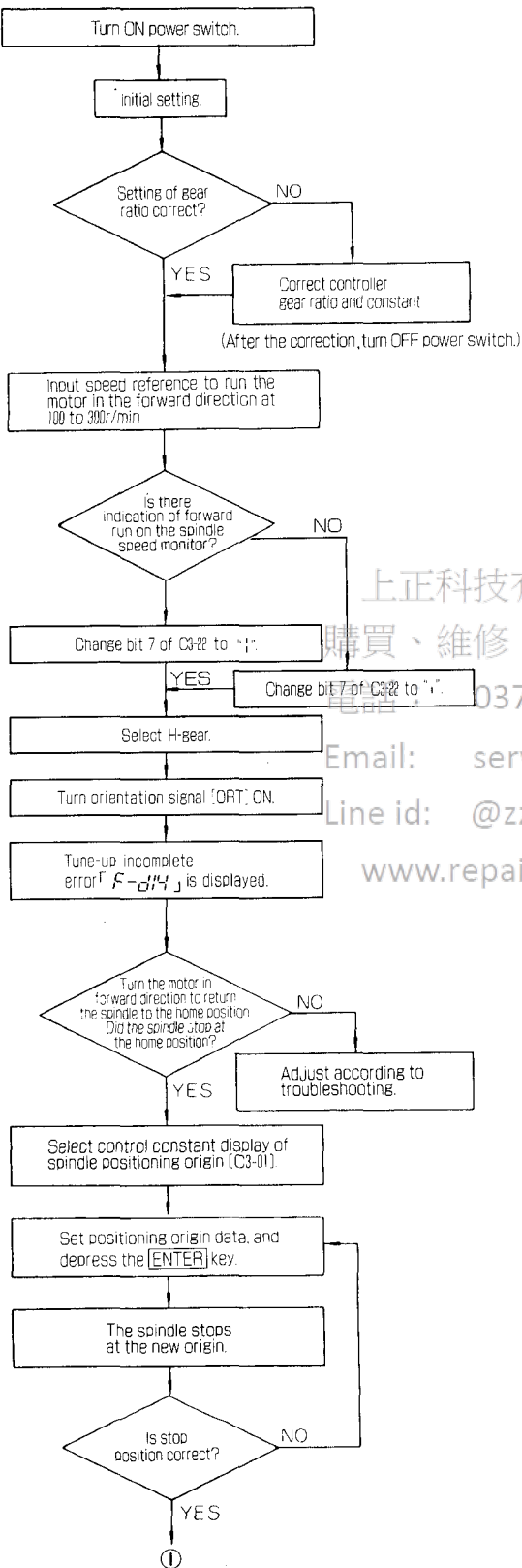
Adjust the system according to the flow chart below.

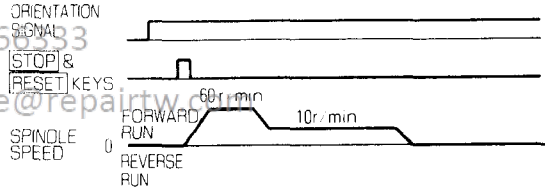
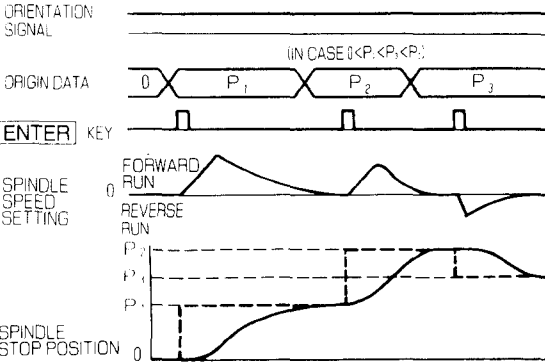
Adjusting Item and Procedure	Content
	<p>Initial setting: Changing constants with the digital operator.</p> <ul style="list-style-type: none"> • Set orientation selection (bit 0) of selection signal 4 (C1-39) to "1". • Set standardized angle of sensor signal (C3-20). • Set tune-up operation selection (bit 4) of orientation select signal 1 (C3-22) to "1". <p>Gear ratio constant</p> <ul style="list-style-type: none"> • C1-27.....H-gear ratio • C1-29.....L-gear ratio <p>} 0.050 to 2.500</p> <ul style="list-style-type: none"> • When gear ratio was selected, the changed constant is effective by turning the power OFF and ON the power. <p>Identifying input signal</p> <ul style="list-style-type: none"> • Interface input status (V1-09)  <p>LIGHTING: ORIENTATION SIGNAL</p> <p>Tune-up operation</p>  <p>Note: Orientation completion signal (ORE) is not output at tune-up operation.</p> <p>Note: Normal if orientation completion signal ORESTS of V3-01 lights.</p> <p>Spindle positioning origin</p> 

(Cont'd)

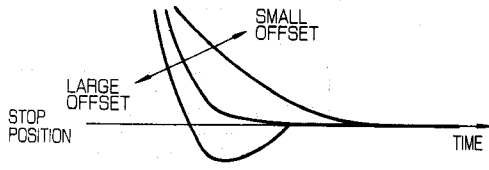
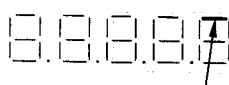
Adjusting Item and Procedure	Content
<p>①</p> <p>Turn orientation signal (ORT) OFF.</p> <p>Tune-up end</p> <p>According to equipment specifications, adjust control constant.</p> <p>Turn orientation signal (ORT) ON.</p> <p>Does it stop smoothly?</p> <p>NO</p> <p>Adjust arbitrary stop position offset (C3-13)</p> <p>YES</p> <p>Is positional accuracy insufficient or is hunting condition present?</p> <p>YES</p> <p>Adjust position control proportional gain (C3-02)</p> <p>NO</p> <p>Select L-gear.</p> <p>Turn orientation signal ON.</p> <p>Is positional accuracy insufficient or is hunting condition present?</p> <p>YES</p> <p>Adjust position control proportional gain (C3-04)</p> <p>NO</p> <p>Turn orientation signal (ORT) ON.</p> <p>End of adjustment</p>	<ul style="list-style-type: none">In case of abnormality during setup, carry out tune-up operations once again, after resetting. Set tune-up operation selection (C3-22, bit 4) to "1". <p>Adjusting control constant</p> <p>Adjustment of arbitrary stop position offset (C3-13)</p> <ul style="list-style-type: none">Adjust so that the final positioning is not slow and that there is no overshoot.  <p>Identify the characteristics from H- and L-gear, because the characteristics vary with load inertia.</p> <p>H-gear Selection</p> <p>Adjusting proportional gain (C3-02)</p> <ul style="list-style-type: none">If [ORE] is not output in the region near the stop position, increase the gain.If the spindle is unstable even if [ORE] is output, reduce the gain. <p>Note: If L-gear selection is not covered by equipment specifications, omit adjustment.</p> <p>Identifying selection of L-gear</p> <ul style="list-style-type: none">Interface input state (V1-09)  <p>Lights when L-gear is selected.</p> <p>Adjusting proportional gain (C3-04)</p> <ul style="list-style-type: none">If [ORE] is not output in the region near the stop position, increase the gain.If the spindle is unstable even if [ORE] is output, reduce the gain.

9. MAINTENANCE

Plan and perform maintenance and management to keep the VS-626VM3C Drives in good condition.



When an inspection is made on the VS-626VM3C, do not touch the inside at least 5 minutes after the power supply is turned OFF. Verify that the smoothing capacitor electric discharge has been completed before starting maintenance.

At this time, the charge indicator lamp "CHARGE" is extinguished.

9.1 DAILY CHECK LIST

Check daily the items listed in the following table.

Table 9.1 Daily Check List

Classification	Check Procedure		Criteria	Remedy
	Check Item	Method		
Ambient	Ambient temperature	Thermometer	Inverter: 0°C to +55°C (above freezing) Motor: 0°C to +40°C	Improve installation environment to meet the specification.
	Humidity	Hydrometer	95% RH or lower (Non-condensing)	Keep to the specification.
	Ventilation	Visual check	Entry and exhaust must not be obstructed.	Remove obstacles.
Power Conditions	Voltage	Voltmeter	Must be from +10% to -15% of rated voltage.	Adjust voltage within the specified range (by a tap changer).
	Current	Ammeter	Must not be greater than the rating. Must be free from cyclic fluctuations.	Adjust load.
Appearance	Dust and stains (with dust, etc.) on the inverter. Dust and stains on the motor shaft opening	Visual check	Must not be obstructing	Clean if very dirty.
Operation Status	Vibration	Touch or use a vibrometer.	Must be free from unusual vibration or increase in magnitude.	If allowable limit is exceeded stop operation and correct the cause.
	Odor	Smell.	Must be free from burning odor.	Stop operation and correct the cause.
	Abnormal sound	Listen.	Must be free from unusual sound or increase of noise.	If operation is hindered, stop operation and correct the cause.
	Rise of inverter or motor temperature	Touch or use a thermometer.	Must be free from excessive temperature rise over normal operating temperature.	Stop operation and cool the system. Check for abnormality in the cooling system (e.g. the fan). Repair them if damaged.
Around the Bearing	Bearing noise	Listen or use a stethoscopic rod.	Must be free from unusual sound or increase of noise.	Supply grease or replace the bearing.
	Vibration	Touch or use a vibrometer.	Must be free from excessive vibration.	
	Bearing temperature	Touch or use a thermometer.	Must be free from excessive temperature rise over normal operating temperature.	
	Grease	Visual check	Must not be leaking.	Correct the cause and restore the normal condition.

9.2 PERIODICAL MAINTENANCE

Clean the inverter periodically as follows.

- (1) If an air filter is used in the control panel, clean the filter once a month.
- (2) Dust on electronic components can lead to overheating and insulation deterioration.

Remove dust periodically. Dust or oil on the heat sink placed on the back of the controller may impair heat dissipation and result in a failure. Clean the heat sink once every six months by blowing compressed air or with a dry cloth. (Clean more frequently if necessary.)

上正科技有限公司

購買、維修 此手冊零組件

電話： 037-466333

Email: service@repairtw.com

Line id: @zzzz

www.repairtw.com

9.3 PERIODICAL CHECK LIST AND ACTION TO BE TAKEN

Refer to Table 9.2 to plan a maintenance schedule for periodical inspection.

Table 9.2 Periodical Inspection

Classification	Check Procedure		Criteria	Remedy
	Check Item	Method		
Daily Inspection Conditions	Inspection record	Visual	–	Use the information in periodical inspection.
Installation Conditions	Tightening bolts of the inverter and the motor	Visual	Must not be loose.	Tighten the bolts.
Grounding	Grounding pins of the inverter and the motor	Visual	Must be grounded securely.	Restore the initial condition and tighten.
Coating	Peeling and Corrosion	Visual	Must be free from damage, discoloration, peeling, and corrosion.	Apply anti-corrosion coating.
Cables and Connections	Loose connection, break in wire cover, terminal box	Visual	Must be free from loose connection or break. Must be free from deterioration or deformation.	Restore the initial condition and tighten.
Cooling Fan	Vibration	Feel manually.	Must be free from unusual vibration or increase in magnitude.	Replace the cooling fan.
	Abnormal sound	Check by hearing.	Must be free from unusual sound or increase of noise.	
Electrolytic Capacitor	Leak and expansion	Visual check	Must be free from abnormalities such as leak of liquid or expansion.	Replace the parts.
	(Capacitance measurement)	(Capacitance measurement instrument)	(Must be within the specifications.)	
Relays and Contactors	Abnormal sound when functioning	Listen.	Must be free from chattering noise.	Replace the parts.
Resistors	Cracks in insulating material	Visual check	Must be free from abnormalities.	Replace the parts.
	Break in wire	Circuit tester and the like	Must be within the range of specifications.	
PC Board	Discoloration	Visual	Must be free from abnormal or partial discoloration.	Replace the PC board.
Control Circuit	Operation check	Inverter stand-alone operation	Output voltage phases must be balanced well.	Adjust the PC board or repair the inverter.
Insulation Resistance	Inverter (Between the main circuit and ground)	Insulation resistance meter	Must be above the specifications.	Repair.
	Motor (Between the stator and ground)			Dry the stator windings. If insulation is not within specs, repair it.
Motor Connection Conditions	Run-out	See Table 10.2.	See Table 10.2.	Readjust direct coupling and positioning.
1. Shaft Coupling	Sunk keys	Visual	Must be free from damage and deformation.	Replace parts.
	Shaft coupling without key		Alignment marks must match.	Restore initial conditions.
2. V-belt	Tightening reamer bolt		Must not be loose.	Tighten the bolt.
	Abrasion		Abrasion must be slight.	Replace the parts.

9.4 INSULATION RESISTANCE TEST (INVERTER)

Perform insulation resistance test for the main circuit using an insulation resistance meter (500V) as explained below.

- (1) Remove wiring from the pins of the inverter main and control circuits. Check insulation resistance between the main circuit pins and the ground (Grounding pin G(E)).
- (2) Normal indication is $1M\Omega$ or greater.

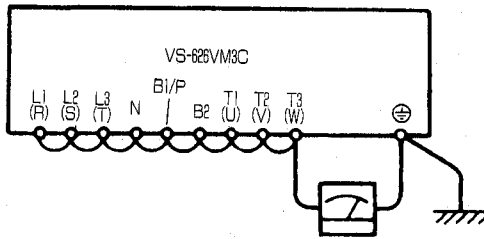

Note: Do not perform the test on control circuit pins.

Fig. 15.1 Insulation Resistance Test (Inverter)

上正科技有限公司
購買、維修 此手冊零組件
電話： 037-466333
Email: service@repairtw.com
Line id: @zzzz
www.repairtw.com

10. TROUBLESHOOTING

If a trouble or an abnormal phenomena occurs in VS-626VM3C Drives, protective functions are activated and operation is stopped in some cases. In other cases, protective functions remain inactive and abnormal status is continued. Tables 10.1 and 10.2 list possible fault causes, checking procedures, and actions to be taken in the two situations. Observe the tables and take necessary action. If the remedy cannot recover normal status or parts need to be replaced, contact your YASKAWA representative and send the following data. (A list of YASKAWA service centers is on the back cover.)

- (1) Abnormal symptoms or activated protective functions
- (2) Status at the time of fault (at power ON, at the start of operation, when operation is halted, during acceleration, during deceleration, etc.)
- (3) Ambient conditions such as temperature and vibration
- (4) Type and serial number of both inverter and motor

上正科技有限公司
購買、維修 此手冊零組件
電話： 037-466333
Email: service@repairtw.com
Line id: @zzzz
www.repairtw.com

Tables 10.1 and 10.2 are organized as follows:

Table 10.1 Fault Cause and Action to be Taken

Activated Protective Function	Situation of Fault						Fault Cause	Troubleshooting		Remedy
	At Power-ON	Operation Started	Operation Halted	During Acceleration	During Deceleration	With load		Checking Procedure	Result	
Emergency Stop Failed (F001)					○		Braking torque was reduced by torque limiting.	Check control constant C1-24. Also check whether TLM was commanded.	TLM was commanded when emergency stop occurred.	Modify the operation circuit to prevent TLM being activated at emergency stop.
									Torque was not limited	
							Motor code selection error	Check control constant C1-25 on the parameter list.	Disagreed with control constant in the list.	Correct the control constant.
								Agreed.	←	

Indication of activated protective function

Possible cause of the fault

If "Contact your YASKAWA representative" is shown in this column, contact him immediately.

Situations where the fault may occur are marked with ○. Use the data to narrow down possible causes.

購買、維修 此手冊零組件

電話： 037-466333

Email: service@repairtw.com

Line id: @zzzz

www.repairtw.com

Take action described in the right column.

Proceed to the next step.

Table 10.1 Fault Cause and Action to be Taken

Activated Protective Function	Situation of Fault						Fault Cause	Troubleshooting		Remedy
	At Power-ON	Operation Started	Operation Halted	During Acceleration	During Deceleration	With load		Checking Procedure	Result	
Emergency Stop Failed (F001)							Braking torque was reduced by torque limiting.	Check control constant C1-24. Also check whether [TLIM] was commanded.	[TLIM] was commanded when emergency stop occurred.	Modify the operation circuit to prevent [TLIM] being activated at emergency stop.
								Torque was not limited	↙	
						○	Motor code selection error	Check control constant C1-25 on the parameter list.	Disagreed with control constant in the list.	Correct the control constant.
								Agreed.	↙	
							Excess load inertial momentum	Check if accel/decel time to reach the rated speed is 10 seconds or longer. (Set 0.1 second for C1-10.)	10 seconds or longer	<ul style="list-style-type: none"> • Reduce inertial momentum. • Increase inverter capacity.
								Less than 10 seconds	↙	
	○	○	○	○	○	Controller fault	Check if the fault can be reproduced.	Reproduced.	Replace the controller.	
								Not reproduced.	Continue operation with care.	
Inverter Output Over-current (F100)		○				Erroneous wiring in the main circuit	Check wiring on the connection diagram.	Erroneous wiring	Correct wiring of the main circuit.	
								Proper wiring		↙
						Layer short circuit in the motor winding	Check resistance between motor terminals. [A circuit tester is necessary.]	Short-circuited	Replace the motor. [Contact your YASKAWA representative.]	
		○	○	○	○			Normal		↙
					Ground fault	Check of an input or output pin of the inverter is short-circuited with the ground.	Ground fault	Repair short-circuited portion.		
							Normal		↙	

Table 10.1 Fault Cause and Action to be Taken (Cont'd)

Activated Protective Function	Situation of Fault						Fault Cause	Troubleshooting		Remedy
	At Power-ON	Operation Started	Operation Halted	During Acceleration	During Deceleration	With load		Checking Procedure	Result	
									Normal	
Inverter Output Over-current (F100)							Motor encoder fault	Check for abnormal changes of motor speed on the speedometer or operation status display (V1-01)	Speed is abnormal. Normal <input type="checkbox"/>	Replace the encoder or the motor. [Contact your YASKAWA representative]
		○		○	○	○	Motor code selection error	Check control constant C1-25 on the parameter list.	Disagreed with control constant in the list. Agreed. <input type="checkbox"/>	Correct the control constant.
							Control constant setting error	Check the control constants on the parameter list.	Disagreed with control constants in the list. Agreed <input type="checkbox"/>	Correct the control constants.
							Connection error or disconnection in the current detection signal wire.	Check if connector 7CN is loose.	Loose Normal <input type="checkbox"/>	Insert the pins and connectors securely.
		○	○	○	○	○	Damage of the IGBT module	Check resistance of the IGBT module.	Abnormal Within specifications <input type="checkbox"/>	Replace the IGBT module. [Contact your YASKAWA representative]
							Controller fault	Check if the fault can be reproduced.	Reproduced. Not reproduced.	Replace the controller. Continue operation with care.
							Fault of the main circuit magnetic contactor (MC) (Wire break in the coil or loose contact)	Check whether the MC is activated within several seconds after emergency stop is canceled.	Not activated. Activated. <input type="checkbox"/>	Repair the inverter. (Replace the MC.) [Contact your YASKAWA representative.]
		○	○	○	○	○	Controller fault	Check if the fault can be reproduced.	Reproduced. Not reproduced.	Replace the controller. Continue operation with care.
Braking Transistor Error (F301)		○	○	○	○	○	IGBT fault for braking.	Check the resistance value of the IGBT module for braking.	Abnormal Within specifications <input type="checkbox"/>	Repair the inverter. (Replace the IGBT for braking.) [Contact your YASKAWA representative.]
							Controller fault	Check if the fault can be reproduced.	Reproduced. Not reproduced.	Replace the controller. Continue operation with care.
Cooling Fan Error (F302)		○	○	○	○	○	Cooling fan fault (Capacity exceeding 1.5kW)	Check the cooling fan mounted on the inverter rear side is operating.	Cooling fan fault Cooling fan power supply (19CN) is disconnected.	Replace the cooling fan. Insert 19CN.
							Controller fault	Check if the fault can be reproduced.	Reproduced. Not reproduced.	Replace the controller. Continue operation with care.

Table 10.1 Fault Cause and Action to be Taken (Cont'd)

Activated Protective Function	Situation of Fault						Fault Cause	Troubleshooting		Remedy
	At Power-ON	Operation Started	Operation Halted	During Acceleration	During Deceleration	With load		Checking Procedure	Result	
Inverter Over-voltage (F400)							Power voltage is too high.	Check voltage between input pins.	Voltage is out of the specification range. Normal <input type="checkbox"/>	Adjust power voltage within specification range by a tap changer.
							Motor code selection error	Check control constant C1-25 on the parameter list	Disagreed with control constant in the list. Agreed. <input type="checkbox"/>	
							Control constant setting error	Check the control constants on the parameter list.	Disagreed with control constants in the list. Agreed. <input type="checkbox"/>	Correct the control constant.
							Fault of the main circuit magnetic contactor (MC) (Wire break in the coil or loose contact)	Check whether the MC is activated within several seconds after emergency stop is canceled.	Not activated. Activated. <input type="checkbox"/>	
							Controller fault	Check if the fault can be reproduced.	Reproduced. Not reproduced. <input type="checkbox"/>	Replace the controller. Continue operation with care.
							Malfunctioning because of noise (Poor encoder cable characteristics)	Check encoder cable specifications (whether the cable is a twisted pair shielded wire).	Not a twisted pair shielded wire Normal <input type="checkbox"/>	
							Motor encoder fault	Check for abnormal changes of motor speed on the speedometer or operation status display (V1-01).	Speed is abnormal. Normal <input type="checkbox"/>	Replace the encoder or the motor. [Contact your YASKAWA representative.]
							Control constant setting error	Check the control constants on the parameter list.	Disagreed with control constants in the list. Agreed. <input type="checkbox"/>	
						Controller fault	Check if the fault can be reproduced.	Reproduced. Not reproduced. <input type="checkbox"/>	Replace the controller. Continue operation with care.	
Motor Over-speed (F500)										

Table 10.1 Fault Cause and Action to be Taken (Cont'd)

Activated Protective Function	Situation of Fault						Fault Cause	Troubleshooting		Remedy
	At Power-ON	Operation Started	Operation Halted	During Acceleration	During Deceleration	With load		Checking Procedure	Result	
									Result	
Power Voltage Error 1	○	○	○	○	○	○	Wide distortion of power voltage 	Check waveform of voltage between input pins. (Must be free from large gaps) [An oscilloscope is necessary.]	There is a gap in voltage waveform.	Modify power supply system.
							Open phase in power current or power loss	Check voltage between input pins.	Phase is missing or power loss occurred.	Correct the cause of power distortion.
							Power voltage is low (because regenerative performance is deteriorated by voltage drop).	Check voltage between input pins.	Voltage is out of the specified range.	Adjust power voltage within specified range by a tap changer.
							Controller fault	Check if the fault can be reproduced.	Reproduced.	Replace the controller.
Power Voltage Error 2 (F604)	○	○	○	○	○	○	Controller fault	Not reproduced.	Continue operation with care.	
								Motor overload	Check load status on the load ratio meter.	Overloaded
Inverter Output Overload (F700)	○	○	○	○	○	○	Frequent accel/ decel	Check frequency of accel/ decel from operation pattern.	Frequent	Reduce frequency of accel/ decel.
							Erroneous wiring or connection in the main circuit	Check wiring between the inverter and the motor.	Erroneous wiring	Correct wiring of the main circuit.
									Proper wiring	
							Motor encoder fault	Check for abnormal changes of motor speed on the speedometer or operation status display (V1-01).	Speed is abnormal.	Replace the encoder or the motor. [Contact your YASKAWA representative.]
									Normal	
							Disconnection, erroneous connection, or loose connector in the encoder signal wires	Check wiring of the encoder signal wires.	Erroneous wiring	Correct wiring of the encoder signal wires.
Proper wiring										
Motor code selection error	Check control constant C1-25 on the parameter list.	Disagreed with control constant in the list.	Correct the control constant.							
Control constant setting error	Check the control constants on the parameter list.	Disagreed with control constants in the list.	Correct the control constants.							
		Agreed.								

Table 10.1 Fault Cause and Action to be Taken (Cont'd)

Activated Protective Function	Situation of Fault						Fault Cause	Troubleshooting		Remedy
	At Power-ON	Operation Started	Operation Halted	During Acceleration	During Deceleration	With load		Checking Procedure	Result	
Inverter Output Overload (F700)	○	○	○	○	○	○	Controller fault	Check if the fault can be reproduced.	Reproduced.	Replace the controller.
									Not reproduced.	Continue operation with care.
Excess Speed Deviation (F800)	○	○	○	○	○	○	Motor overload	Check if load is excessive or a blade is caught.	Overloaded	Reduce load.
								Normal	←	
							Torque limiting operation	Check if external torque limiting signal [TLIM] was input.	Torque was limited.	Cancel torque limiting.
								Torque was not limited.	←	
							Control constant setting error	Check the control constants on the parameter list.	Disagreed with control constants in the list.	Correct the control constants.
								Agreed.	←	
							Erroneous wiring or connection in the main circuit	Check wiring between the inverter and the motor.	Erroneous wiring	Correct wiring of the main circuit.
								Proper wiring		
							Disconnection, erroneous connection, or loose connector in the encoder signal wires	Check wiring of the encoder signal wires.	Erroneous wiring	Correct wiring of the encoder signal wires.
								Proper wiring	←	
Malfunctioning because of noise (Poor encoder signal wire characteristics)	Check encoder signal wire specifications (Whether the signal wire is a twisted pair shielded wire).	Not a twisted pair shielded wire	Replace the encoder signal wire. [Recommended cable: KQVV-SW manufactured by FUJIKURA Ltd.]							
	Normal	←								
Motor encoder fault	Check for abnormal changes of motor speed on the speedometer or operation status display (V1-01)	Speed is abnormal.	Replace the encoder or the motor. [Contact your YASKAWA representative.]							
	Normal	←								
Controller fault	Check if the fault can be reproduced.	Reproduced.	Replace the controller.							
		Not reproduced.	Continue operation with care.							
Motor Thermal Error 1 (F900)	○	○	○	○	○	Motor overload	Check motor temperature on the operation status display (V7-01)	Motor Temperature is near the upper limit.	Stop operation and cool the motor.	
							Motor temperature is low.	←		
Motor Thermal Error 2 (F901)	○	○	○	○	○	Disconnection in the motor cooling fan power cable	Check wiring on the connection diagram.	Erroneous wiring	Correct wiring of the motor cooling fan power cable.	
							Proper wiring	←		
Motor cooling fan fault	○	○	○	○	○	Motor cooling fan fault	Turn ON power and check if motor cooling air flow is normal.	Cooling air does not flow.	Replace the motor cooling fan or the motor. [Contact your YASKAWA representative]	
							Normal	←		

Table 10.1 Fault Cause and Action to be Taken (Cont'd)

Activated Protective Function	Situation of Fault						Fault Cause	Troubleshooting		Remedy
	At Power-ON	Operation Started	Operation Halted	During Acceleration	During Deceleration	With load		Checking Procedure	Result	
Motor Thermal Error 1 (F900)					○	○	Deteriorated motor cooling performance	Check for dust and oil in the passage of motor cooling air.	Excessive dust/oil Normal	Clean the motor. [Disassembling and cleaning may be required depending on extent of contamination. Contact your YASKAWA representative.]
									←	
Motor Thermal Error 2 (F901)	○	○	○	○	○	○	Thermistor signal wire disconnection	Check wiring of the motor thermistor signal wires.	Erroneous wiring Proper wiring	Correct wiring of the motor thermistor signal wires.
							Controller fault	Check if the fault can be reproduced.	Reproduced. Not reproduced.	Replace the controller.
Motor Thermal Error 3 (F902)	○		○				Motor temperature is low.	Check motor ambient temperature.	-10°C or lower -10°C or higher	Warm the ambient air to -10°C or higher. [Monitor the motor temperature on operation status display (V7-1).]
							Thermistor signal wire disconnection	Check motor temperature on the operation status display (V7-01).	-10°C or lower -10°C or higher	Correct wiring of the motor thermistor signal wires.
	○	○	○	○	○	○	Controller fault	Check if the fault can be reproduced.	Reproduced. Not reproduced.	Replace the controller. Continue operation with care.
									←	
Heat Sink Thermal Error 2 (F904)							Inverter overload	Check the heat sink temperature on operation status display (V1-13, heat sink temperature).	Heat sink temperature is near the upper limit. Heat sink temperature is low.	Stop operation and cool the inverter.
							Inverter cooling fan fault	Turn ON power and check if inverter cooling air flow is normal.	Cooling air does not flow. Normal	Replace the inverter cooling fan. [Contact your YASKAWA representative.]
							Deteriorated heat sink cooling performance	Check for dust and oil on the heat sink.	Excessive dust/oil. Normal	Clean the heat sink of the inverter. [Disassembling and cleaning may be required depending on the extent of contamination. Contact your YASKAWA representative.]
							Thermoswitch signal wire disconnection	Check wiring of the heat sink thermoswitch signal wires.	Erroneous wiring Proper wiring	Correct wiring of the heat sink thermoswitch signal wires.
						Controller fault	Check if the fault can be reproduced.	Reproduced. Not reproduced.	Replace the controller. Continue operation with care.	

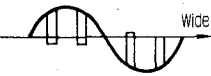
Table 10.1 Fault Cause and Action to be Taken (Cont'd)

Activated Protective Function	Situation of Fault						Fault Cause	Troubleshooting		Remedy
	At Power-ON	Operation Started	Operation Halted	During Acceleration	During Deceleration	With load		Checking Procedure	Result	
Initial Charging Incomplete (FA00)	○						Fault of the charge current suppression resistor	Check whether the main circuit capacitor is charged on operation status display (V1-14)	Capacitor voltage is not greater than 1.2 times of the input voltage (rms).	Repair the inverter. (Replace the charge current suppression resistor.) [Contact your YASKAWA representative.]
									Voltage is normal.	
							Controller fault	Check if the fault can be reproduced.	Reproduced.	Replace the controller.
									Not reproduced.	Continue operation with care.
Blown Fuse (FA01)	○	○	○	○	○	○	Blown fuse	Check the conduction of the fuse (FU1).	Not conducted.	Repair the inverter. (Replace the fuse and IGBT.) [Contact your YASKAWA representative.]
									Conducted.	
							Controller fault	Check if the fault can be reproduced.	Reproduced.	Replace the controller.
									Not reproduced.	Continue operation with care.
Controller Fault 1 to 9 (Fb00 to 03 Fd00, FE00 to 03)	○	○	○	○	○	○	Controller fault	Check if the fault can be reproduced.	Reproduced.	Replace the controller.
									Not reproduced.	Continue operation with care.
I/O Error 1 to 2 (FF00 to 03)										

上正科技有限公司
 購買、維修、二手電氣零件
 電話：037-466333
 Email: service@repairtw.com
 Line id: @zzzz
 www.repairtw.com

Table 10.1 Fault Cause and Action to be Taken (Cont'd)

Activated Protective Function	Situation of Fault						Fault Cause	Troubleshooting		Remedy
	At Power-ON	Operation Started	Operation Halted	During Acceleration	During Deceleration	With load		Checking Procedure	Result	
Disconnection in Speed Detection Signal Wire (FC00)							Disconnection, erroneous connection, or loose connector in the encoder signal wires	Check wiring of the encoder signal wires.	Erroneous Wiring Proper wiring	Correct wiring of the encoder signal wires.
							Controller fault	Check if the fault can be reproduced.	Reproduced. Not reproduced.	Replace the controller. Continue operation with care.
Load Error (FC01)							Inverter output wiring (U,V,W) disconnection, or erroneous connection	Check wiring between inverter and motor.	Erroneous wiring Proper wiring	Correct inverter output wiring.
							Motor encoder fault	Check for the detection of motor speed on speedometer or operation status display (VI-01).	Speed not detected. Normal	Replace encoder and motor. [Contact your YASKAWA representative.]
							Controller fault	Check if fault can be reproduced.	Reproduced. Not reproduced.	Replace controller. Continue operation with care.
Soft Version Unmach (Fd01)							Controller and PROM versions unmatch.	Compare controller code number and PROM number to check applicable version.	Mismatched. Normal	Replace with proper applicable PROM. [Contact your YASKAWA representative.]
							Controller fault	Check if the fault can be reproduced.	Reproduced. Not reproduced.	Replace the controller. Continue operation with care.
Position Detector Fault 1 (Fd11) Disconnection in Position Detector Signal Wires (Fd16)							Disconnection in the load axis encoder phase-C signal wire	Check wiring of the load axis encoder signal wire.	Erroneous Wiring Proper wiring	Correct wiring of the load axis encoder signal wires.
							Load axis encoder fault	Turn the load axis by hand and monitor operation status display (V1-10) to check whether [ORG] signal lights once per rotation.	Remains OFF. Lights.	Replace the load axis encoder. Tune up again.
							Orientation card fault	Check phase-A, -B, and -C pulses at the check pins on the orientation card. [An oscilloscope is necessary.]	Phase -A, -B, and -C phases are normal. Pulses are missing	Replace the orientation card. Replace the load axis encoder.

Table 10.1 Fault Cause and Action to be Taken (Cont'd)

Activated Protective Function	Situation of Fault						Fault Cause	Troubleshooting		Remedy	
	At Power-ON	Operation Started	Operation Halted	During Acceleration	During Deceleration	With load		Checking Procedure	Result		
Position Detector Fault 2 (Fd12) Position Detector Fault 3 (Fd13)		○					Load axis encoder fault	Check phase-A, -B, and -C pulses at the check pins on the orientation card. [An oscilloscope is necessary.]	Pulses are missing or pulse width is abnormal. Pulses are normal.	Replace the load axis encoder.	
							Controller fault	Check if the fault can be reproduced.	Reproduced. Not reproduced.		Replace the controller. Continue operation with care.
Tune-up Incomplete (Fd14)		○					Tune-up for orientation was incompleting.	--	--	Adjust according to Par. 8.4, "ADJUSTMENT PROCEDURE AND CONTROL CONSTANT SETUP."	
INC Error (Fd15)	○						Power was turned ON when [INC] was ON.	Run again using the same operation parameters to reproduce the fault.	INC error occurred again.	Modify the circuit so that [INC] is commanded after absolute positioning is performed.	
							[INC] was turned ON while the motor was rotating.		Normal		Continue operation with care.
Disconnection in Magnetic Sensor Signal Wire (Fd17) Position Detector Fault 1 (Fd11)	○						Disconnection in the magnetic sensor signal wire	Check wiring of the magnetic sensor signal wire.	Erroneous wiring Proper wiring	Correct wiring of the magnetic sensor signal wire.	
							Magnetic sensor fault	Turn the load axis by hand and monitor operation status display (V1-10) to check whether [ORG] signal lights once per rotation.	Remains OFF.	Replace the magnetic sensor.	
									Lights.	Tune up again.	
Orientation Card Mismatch (Fd18)	○						Mismatched orientation card and orientation selecting parameter.	Check the orientation card type and orientation selecting signal (bit 0 of C1-39)	Disagreed with control constant in the list. Matched.	Set the proper value to the control constant.	
							Defective mounting of orientation card	Check that the connector (22CN) is inserted securely.	Loosened.		Insert the connector securely.
									Normal		
Orientation card error							Check if the fault can be reproduced.	Reproduced.	Replace the orientation card.		
								Not reproduced.	Continue operation with care.		

Table 10.2 Cause of Troubles and Action to be Taken

Trouble	Situation of Fault						Fault Cause	Troubleshooting		Remedy
	At Power-ON	Operation Started	Operation Halted	During Acceleration	During Deceleration	With load		Checking Procedure	Result	
Unregistered Motor code (FE05)	○						Motor code selection error	Check control constant C1-25 in the parameter list.	Disagreement with control constant in the list. Matched	Change the control constant to the proper value.
							Controller and PROM versions disagreement	Check the applicable PROM version in the list.	Mismatched Normal	Replace the proper applicable PROM. [Contact your YASKAWA representative.]
							Controller fault	Check if the fault can be reproduced.	Reproduced Not reproduced	Replace the controller. Continue operation with care.
CPU Fault 1 (CPF 00) CPU Fault 2 (CPF 01)	○	○	○	○	○	○	Digital operator connection error	Check that the connector (3CN) is inserted securely.	Loosened Normal	Insert the connector again securely.
							Disconnection in the reference voltage (+15V) signal for analog speed reference.	Check the wiring of reference voltage (+15V) signal (1CN-1).	Erroneous wiring Normal	Correct wiring of the reference voltage (+15V) signal.
							Controller fault	Check if the fault can be reproduced.	Reproduced Not reproduced	Replace the controller. Continue operation with care.

Table 10.2 Cause of Troubles and Action to be Taken

Trouble	Situation of Fault						Fault Cause	Troubleshooting		Remedy
	At Power-ON	Operation Started	Operation Halted	During Acceleration	During Deceleration	With load		Checking Procedure	Result	
The motor does not rotate.							Protective function has been activated.	Check for errors on the digital operator in protective function operation display mode.	Protective function has been activated.	Start troubleshooting according to Table 10.1 "Fault cause and action to be taken."
								Normal.	←	
							Disconnection or erroneous connection in the main circuit	Check wiring between the inverter and the motor.	Erroneous wiring.	Correct wiring of the main circuit.
								Proper wiring	←	
							Control signal is not functioning.	Check operation status display (V1-09) to see whether the following sequence input signals are input: • Operation ready [RDY] • Emergency stop [EMG] Operation [FWD] or [REV] Also check operation status display (V1-02) to see whether the speed instruction [SCOM] is input.	Control signals are missing.	Modify the circuit so that control signals are input properly.
								Normal	←	
							Torque limiting	Check if external torque limiting [TLIM] is input.	Torque is limited.	Cancel torque limiting.
								Torque is not limited.	←	
						Break in wire in motor windings	Check resistance between motor pins. [A circuit tester is necessary.]	Winding resistance is abnormal. (Infinity)	Replace the motor. [Contact your YASKAWA representative]	
							Normal	←		
						Motor fault • The rotor and the stator are in contact with each other. • Bearing is broken.	Turn the motor shaft by hand to see if it moves.	The shaft does not rotate.	Replace the motor. [Contact your YASKAWA representative]	
							The shaft rotates easily.	←		
						Controller fault	Check if the fault can be reproduced.	Reproduced.	Not reproduced.	
								Replace the controller.	Continue operation with care.	

Table 10.2 Cause of Troubles and Action to be Taken (Cont'd)

Trouble	Situation of Fault						Fault Cause	Troubleshooting		Remedy
	At Power-ON	Operation Started	Operation Halted	During Acceleration	During Deceleration	With load		Checking Procedure	Result	
The motor rotates slowly, or only vibrates but does not rotate at all.							Disconnection or erroneous connection in the main circuit	Check wiring between the inverter and the motor.	Erroneous wiring Proper wiring	Correct wiring of the main circuit.
							Disconnection, erroneous connection, or loose connector in the encoder signal wires.	Check wiring of the encoder signal wires.	Erroneous wiring Proper wiring	Correct wiring of the encoder signal wires.
							Motor encoder fault	Check for abnormal changes in motor speed on the speedometer or operation status display (V1-01).	Speed is abnormal. Normal.	Replace the encoder or the motor. [Contact your YASKAWA representative.]
							Disconnection or erroneous connection in the speed instruction signal wire	Check wiring of the speed instruction signal wire.	Erroneous wiring Proper wiring	Correct wiring of the speed instruction signal wire.
							Torque limiting	Check if external torque limiting signal [TLIM] is input.	Torque is limited. Torque is not limited.	Cancel torque limiting.
							Controller fault	Check if the fault can be reproduced.	Reproduced. Not reproduced.	Replace the controller. Continue operation with care.
The motor rotates in reverse direction.							Erroneous connection in the signal wires in the main circuit motor encoder.	Check wiring according to the connection diagram.	Erroneous wiring	Correct wiring of the signal wires of the main circuit motor encoder.
The motor does not rotate at commanded speed.							Speed instruction signal error	Check speed instructions on operation status display (V1-02).	Commanded speed is abnormal. Normal	Readjust speed commanding function of the higher system.
							Erroneous setting of motor rated speed	Check control constant C1-26 on the parameter list.	Disagreed with control constant in the list. Agreed.	Correct the control constant.
							Motor speed adjustment error	Check motor speed on operation status display (V1-01).	Motor speed disagrees with the commanded value. Normal	Adjust motor speed using control constant C1-12.
							Torque limiting	Check if external torque limiting signal [TLIM] is input.	Torque is limited. Torque is not limited.	Cancel torque limiting.
							Controller fault	Check if the fault can be reproduced.	Reproduced. Not reproduced.	Replace the controller. Continue operation with care.

Table 10.2 Cause of Troubles and Action to be Taken (Cont'd)

Trouble	Situation of Fault						Fault Cause	Troubleshooting		Remedy
	At Power-ON	Operation Started	Operation Halted	During Acceleration	During Deceleration	With load		Checking Procedure	Result	
Extended Accel/ decel Time							Soft starter time setting error (Set time is too long.)	Check control constant C1-10 on the parameter list.	Disagreed with control constant in the list. Agreed. <input type="checkbox"/>	Correct the control constant.
							Motor code selection error	Check control constant C1-25 on the parameter list.	Disagreed with control constant in the list. Agreed. <input type="checkbox"/>	Correct the control constant.
		○		○		○	Torque limiting	Check if external torque limiting signal [TLIM] is input.	Torque is limited. Torque is not limited. <input type="checkbox"/>	Cancel torque limiting
							Excess load on the load machine	Check load status on the load ratio meter for loss and inertial momentum of the load machine.	Load is excessive. Normal <input type="checkbox"/>	Reduce loss and inertial momentum of the load machine. Increase drive capacities of the inverter and the motor.
							Controller fault	Check if the fault can be reproduced.	Reproduced. Not reproduced. <input type="checkbox"/>	Replace the controller. Continue operation with care.
Motor noise and vibration are high.							Disconnection in the main circuit	Check wiring between the inverter and the motor	Erroneous wiring Proper wiring <input type="checkbox"/>	Correct wiring in the main circuit.
							Grounding error of the motor or the inverter	Check continuity of the motor and the inverter to see if they are securely grounded.	Grounding is insufficient. Normal <input type="checkbox"/>	Use pin E and securely ground the equipment.
		○		○		○	Malfunctioning because of noise (Poor encoder cable characteristics).	Check encoder cable specifications (whether the cable is a twisted pair shielded wire).	Not a twisted pair shielded wire Normal <input type="checkbox"/>	Replace the encoder cable [Recommended cable: KQVV-SW manufactured by FUJIKURA Ltd.]
							Control constant setting error (especially the speed control proportional control gain)	Check control constants on the parameter list.	Disagreed with control constant in the list. Agreed. <input type="checkbox"/>	Correct the control constants.
							Motor installation error	Check for loose mounting screws.	Loose Normal <input type="checkbox"/>	Tighten mounting screws.
							Unbalanced motor	Check balance of the rotor	Not dynamically balanced Normal <input type="checkbox"/>	Replace the motor [Contact your YASKAWA representative.]

Table 10.2 Cause of Troubles and Action to be Taken (Cont'd)

Trouble	Situation of Fault						Fault Cause	Troubleshooting		Remedy
	At Power-ON	Operation Started	Operation Halted	During Acceleration	During Deceleration	With load		Checking Procedure	Result	
									Result	
Motor noise and vibration are high.							Motor fault (• Motor bearing fault • Rotor fault	Run single motor alone, and check if noise and vibration are within the specifications.	Out of specifications Within specifications <input checked="" type="checkbox"/>	Replace the motor. [Contact your YASKAWA representative]
							Positioning or load-machine coupling error	Check coupling and positioning according to Par. 3.1.3, "Connection with Load Machine."	Coupling or positioning precision was insufficient. Normal <input checked="" type="checkbox"/>	Readjust coupling and perform positioning again.
		○		○		○	Insufficient strength of the load machine.	Check for deformation or resonant point on the load machine.	Deformation or resonant point was found. Normal <input checked="" type="checkbox"/>	Reinforce the load machine.
							Loose foundation bolt.	Check for loose foundation bolt on the load machine.	Loose bolt was found. Normal <input checked="" type="checkbox"/>	Tighten the foundation bolts.
							Controller fault	Check if the fault can be reproduced.	Reproduced. Not reproduced.	Replace the controller. Continue operation with care.
Motor does not stop.							Control signal does not operate.	Check that operation signal (FWD) or (REV) is open according to operation status display (V1-09).	Operation signal is not open. Normal. <input checked="" type="checkbox"/>	Change the reference circuit so that operation signal will be open without fail when the spindle is stopped.
							Controller fault	Check if the fault can be reproduced.	Reproduced. Not reproduced.	Replace the controller. Continue operation and check the status.
Motor does not stop at orientation.							Orientation signal [ORT] is not input.	Check that orientation signal [ORT] is closed according to operation status display (V1-09).	Control signal is not input. Normal <input checked="" type="checkbox"/>	Change the circuit so that the control signal will be input normally.
							Improper selection signal setting	Verify selection signal setting to compare it to the setting list. • C1-39 bit 0 0: Encoder type 1: Magnetic sensor type • C2-22 bit 6 0: Spindle encoder 1: Motor encoder	Does not match with control constant in setting list. Matches. <input checked="" type="checkbox"/>	Change the control constant to a proper value.
							Encoder signal disconnection, improper connector [encoder type]	Check wiring of encoder signal lines.	Improper wiring Normal wiring <input checked="" type="checkbox"/>	Correct the encoder signal line wiring.

Table 10.2 Cause of Troubles and Action to be Taken (Cont'd)

Trouble	Situation of Fault						Fault Cause	Troubleshooting		Remedy
	At Power-ON	Operation Started	Operation Halted	During Acceleration	During Deceleration	With load		Checking Procedure	Result	
Motor does not stop at orientation							Encoder fault [encoder type]	Verify that the motor speed changes normally by speedometer indication or operation status display (V1-01).	Speed indicates an abnormal value Normal	Replace the encoder or motor. [Contact your YASKAWA representative.]
							Magnetic sensor signal disconnection, improper connection, removal of connector [magnetic sensor type]	Check the wiring of magnetic sensor signal lines.	Improper wiring Normal wiring	Replace the orientation card or controller.
							Fault of magnetic sensor or magneto [magnetic sensor type]	Rotate the spindle and verify that the [ORG] signal lights once per rotation by operation status display (V1-01).	Does not light. Lights.	Replace the magnetic sensor or magneto.
							Fault of orientation card or controller	Check if the fault can be reproduced.	Reproduced. Not reproduced.	Replace the orientation card or controller. Continue operation with care.
Stop position differs from the commanded position (encoder type.)							Improper setting of stop position reference	Check whether the position reference is correct by operation status display (V2-04).	Improper position reference Normal	Give a proper stop position reference
							Improper selection of binary/BCD reference or improper setting of BCD reference resolution	Verify the control constant setting and compare it to the setting list. · C2-22 bit3 · C2-12	Does not match the control constant in the setting list. Matches.	Change the control constant to a proper value.
							Improper setting of spindle zero-point position	Perform positioning at zero-point position to measure the position accuracy.	Zero-point position differs. Matches.	Perform adjusting operation again and set the spindle zero-point again.
							Encoder signal line disconnection, improper connection, removal of connector	Check the wiring of encoder signal lines.	Improper wiring Proper wiring	Correct the wiring of the encoder signal lines.
							Malfunction by noise [encoder signal line characteristics fault]	Check the specifications of the encoder cable (if it is twisted pair shielded cable.)	Twisted pair shielded cable is not used. Normal	Replace the encoder cable. [Recommended cable : KQVV-SW made by FUJIKURA Ltd.]
							Controller fault	Check if the fault can be reproduced.	Reproduced. Not reproduced.	Replace the controller. Continue operation with care.

Table 10.2 Cause of Troubles and Action to be Taken (Cont'd)

Trouble	Situation of Fault						Fault Cause	Troubleshooting		Remedy
	At Power-ON	Operation Started	Operation Halted	During Acceleration	During Deceleration	With load		Checking Procedure	Result	
Stop position differs from the commanded position (magnetic sensor type)							Magnetic sensor or magnetizer is mounted in the opposite direction.	Check that the sensor or magnetizer is mounted properly, referring to Par 5.2.6, "Magnetizer and Magnetic Sensor Mounting" and Par. 5.2.7, "Mounting Points".	Mounted in the opposite direction.	Perform tuning operation again.
								Normal	←	
							Magnetic sensor signal line disconnection, removal of connector	Check the wiring of the magnetic sensor signal lines.	Improper wiring	Correct the wiring of the magnetic sensor signal lines.
								Proper wiring	←	
							Orientation card or controller fault	Check if the fault can be reproduced.	Reproduced.	Replace orientation card or controller.
								Not reproduced.	Continue operation with care.	
Orientation completion signal is not output.							Orientation signal [ORT] is not input.	Check that orientation signal [ORT] is closed by operation status display (V1-09).	Control signal is not input.	Change the circuit so that the control signal will be input normally.
								Normal	←	
							Improper setting of selection signal (Completion signal is not output at tuning of initial setting.)	Check that selection signal (X2-22, C3-22 bit 4) is set correctly. 0: Tuning enabled. 1: Tuning disabled.	Bit 4 is not set to 1 after completion of tuning.	Set the selection signal (C2-22, C3-22) to "1"
								Normal	←	
							Improper setting of speed changing ratio	Check that speed changing ratio (C1-27 to 29) are set to proper values by comparing them to the machine specifications.	Machine specifications do not match the speed changing ratio.	Change and set the speed changing ratio to a proper value.
								Matches.	←	
							Position control proportional gain is high.	Check that no vibration occurs in the forward and reverse directions near the stop position.	Vibrates.	Decrease position control proportional gain unless vibration disappears.
						Does not vibrate.		←		
						Position control proportional gain is low.	Check that the spindle has reached the stop position by operation status display (V2-03 or V3-03).	Stop reference position is not reached.	Decrease position control proportional gain so that position control proportional gain reaches the reference position.	
							Reached.	←		
						Orientation card or controller fault	Check if the fault can be reproduced.	Reproduced.	Replace orientation card or controller.	
							Not reproduced.	Continue operation with care.		

11. SPARE PARTS

It is recommended that friction parts to be replaced for safe use of the VS-626VM3C for a long time span. Refer to Table 11.1 and 11.2 for list of spare parts.

Contact YASKAWA CONTROL Co., Ltd. about spare parts.

Table 11.1 Common Spare Parts

Spare Part Names	Control Board	Power Supply Board	Digital Operator
Specifications			
Model	—	—	JVOP-100
Code No.	ETC62201 -S	ETC67010	CDR000070
Quantity	1	1	1

Table 11.2 Spare Parts

Spare Part Names	Specifications	Power Supply Board	Main Circuit Transistor	Main Circuit Diode	Fuse	Cooling Fan
		VS-626VM3C Model				
CIMR-VMC20P4	Model	—	6MBI15L-060	10L6P44	CR2LS-10/UL	—
	Code No.	ETP67002	STR000417	SID000429	FU000823	—
	Q'ty	1	1	1	1	—
CIMR-VMC20P7	Model	—	6MBI20L-060	20L6P44	CR2LS-10/UL	—
	Code No.	ETP67023	STR000418	SID000433	FU000823	—
	Q'ty	1	1	1	1	—
CIMR-VMC21P5	Model	—	6MBI30L-060	6RI30E-080	CR2LS-20/UL	4710NL-05W-B49
	Code No.	ETP67024	STR000419	SID000430	FU000799	FAN000175
	Q'ty	1	1	1	1	1
CIMR-VMC22P2	Model	—	6MBI50L-060	6RI30E-080	CR2LS-30/UL	4710NL-05W-B49
	Code No.	ETP67025	STR000420	SID000430	FU000791	FAN000175
	Q'ty	1	1	1	1	1
CIMR-VMC23P7	Model	—	MA75J2YS1	6RI50E-080M5	CR2LS-50/UL	4710NL-05W-B49
	Code No.	ETP67026	STR000339	SID000431	FU000797	FAN000175
	Q'ty	1	3	1	1	1
CIMR-VMC25P5	Model	—	MG100J2YS1	6RI75E-080	CR2LS-50/UL	4710NL-05W-B49
	Code No.	ETP67027	STR000340	SID000432	FU000797	FAN000175
	Q'ty	1	3	1	1	1

Note: Spare parts in are recommended to be replaced by units, to maintain the quality.

NOTE

請參閱本手冊第 10 頁

上正科技有限公司
購買、維修 此手冊零組件

電話： 037-466333

Email: service@repairtw.com

Line id: @zzzz

www.repairtw.com

NOTE

上正科技有限公司
購買、維修 此手冊零組件
電話： 037-466333
Email: service@repairtw.com
Line id: @zzzz
www.repairtw.com

NOTE

上正科技有限公司
購買、維修 此手冊零組件
電話： 037-466333
Email: service@repairtw.com
Line id: @zzzz
www.repairtw.com

上正科技有限公司
購買、維修 此手冊零組件
電話： 037-466333
Email: service@repairtw.com
Line id: @zzzz
www.repairtw.com

Varispeed-626VM3C DRIVE INSTRUCTION MANUAL

TOKYO OFFICE New Pier Takeshiba South Tower, 1-16-1, Kaigan, Minatoku, Tokyo 105 Japan
Phone 81-3-5402-4511 Fax 81-3-5402-4580

YASKAWA ELECTRIC AMERICA, INC.

Chicago-Corporate Headquarters 2942 MacArthur Blvd. Northbrook, IL 60062-2028, U.S.A.

Phone 1-847-291-2340 Fax 1-847-498-2430

Chicago-Technical Center 3160 MacArthur Blvd. Northbrook, IL 60062-1917, U.S.A.

Phone 1-847-291-0411 Fax 1-847-291-1018

MOTOMAN INC.

805 Liberty Lane West Carrollton, OH 45449, U.S.A.

Phone 1-937-847-6200 Fax 1-937-847-6277

YASKAWA ELÉTRICO DO BRASIL COMÉRCIO LTDA.

Avenida Brigadeiro Faria Lima 1664-5 CJ 504/511, São Paulo, Brazil

Phone 55-11-815-7723 Fax 55-11-870-3849

YASKAWA ELECTRIC EUROPE GmbH

Am Kronberger Hang 2, 65824 Schwalbach, Germany

Phone 49-6196-569-300 Fax 49-6196-888-301

Motoman Robotics AB

Box 504 S38525 Torsås, Sweden

Phone 46-486-48800 Fax 46-486-41410

Motoman Robotec GmbH

Kammerfeldstraße 1, 85391 Allershausen, Germany

Phone 49-8166-900 Fax 49-8166-9039

YASKAWA ELECTRIC UK LTD.

Unit2 Centurion Court Brick Close, Kiln Farm, Milton Keynes MK11 3JA, United Kingdom

Phone 44-1908-565874 Fax 44-1908-565891

YASKAWA ELECTRIC KOREA CORPORATION

Paik Nam Bldg. 901 188-3, 1-Ga Euljiro, Joong-Gu Seoul, Korea

Phone 82-2-776-7844 Fax 82-2-753-2639

YASKAWA ELECTRIC (SINGAPORE) PTE. LTD.

151 Lorong Chuan, #04-01, New Tech Park Singapore 556741, Singapore

Phone 65-282-3003 Fax 65-289-3003

YATEC ENGINEERING CORPORATION

Shen Hsiang Tang Sung Chiang Building 10F 146 Sung Chiang Road, Taipei, Taiwan

Phone 886-2-563-0010 Fax 886-2-567-4677

BEIJING OFFICE Room No. 301 Office Building of Beijing International Club, 21

Jianguomenwai Avenue, Beijing 100020, China

Phone 86-10-532-1850 Fax 86-10-532-1851

SHANGHAI OFFICE 27 Hui He Road Shanghai 200437 China

Phone 86-21-6553-6060 Fax 86-21-6553-6060

YASKAWA JASON (HK) COMPANY LIMITED ice@repairtw.com

Rm. 2909-10, Hong Kong Plaza, 186-191 Connaught Road West, Hong Kong

Phone 852-2803-2385 Fax 852-2547-5773

TAIPEI OFFICE Shen Hsiang Tang Sung Chiang Building 10F 146 Sung Chiang Road, Taipei, Taiwan

Phone 886-2-563-0010 Fax 886-2-567-4677

www.repairtw.com



YASKAWA

YASKAWA ELECTRIC CORPORATION

MANUAL NO. TOE-S626-5B

© Printed in Japan June 1997 93-11 0.5Z

185-244L