

Varispeed-626VM3 DRIVE

DESCRIPTIVE MANUAL

INVERTER DRIVES WITH DIGITAL VECTOR-CONTROL
WITH REGENERATIVE FUNCTION (VS-626VM3)

3.7/2.2 TO 37/30kW (STANDARD TYPE)

5.5/3.7 TO 22/18.5kW (WINDING SELECTION TYPE)

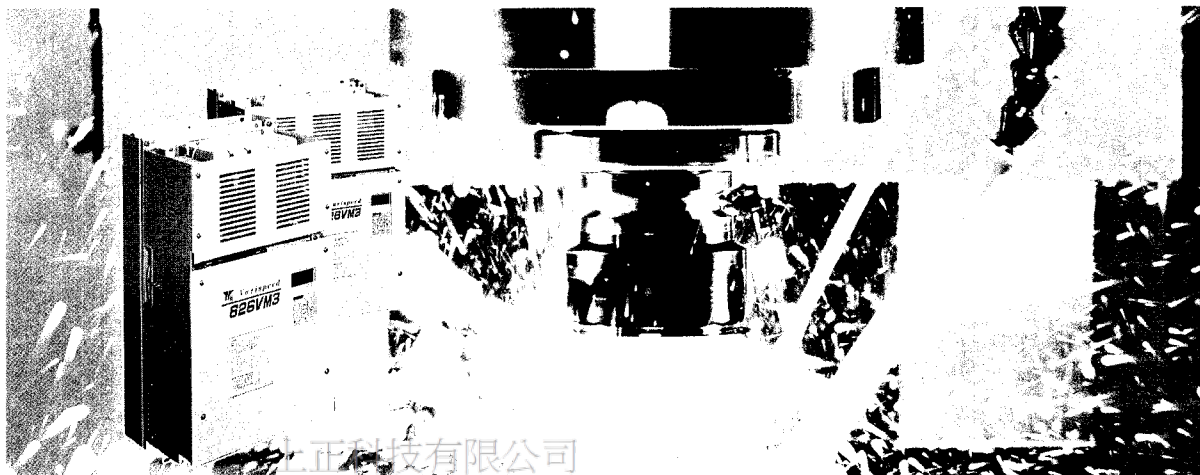

上正科技有限公司

購買、維修 此手冊零組件

電話： 037-466333

Email: service@repairtw.com

Line id: @zzzz

www.repairtw.com



YASKAWA

MANUAL NO. SIE-S626-6C

上正科技有限公司
購買、維修 此手冊零組件
電話： 037-466333
Email: service@repairtw.com
Line id: @zzzz
www.repairtw.com

PREFACE

Varispeed-626VM3 drives (VS-626VM3) combine a compact, high speed AC spindle drive motor with a digital vector-controlled, high performance transistor inverter (controller) with regenerative function.

The VS-626VM3 Drives are highly reliable adjustable speed AC spindle motor drives for NC machine tools such as machining centers and lathes, and manufacturing facilities such as transfer machines and testers. They assure exceptional stability, even at high speeds under severe operating conditions.

The features of the VS-626VM3 are as follows:

- 8000 r/min max and constant power range (1 : 5.3) (for 7.5kW or below)
- Constant power (1 : 12) with winding selection (No speed change gear required)
- Two series for power voltages of 200V and 400V
- Precise setup of position and speed by fully digitalized control
- Compact and lightweight

This manual describes the installation, operation, maintenance and inspection to use the drive system normally and safely. Read this manual thoroughly before operation.

This manual gives operation examples under typical conditions. For applications under special conditions, contact your YASKAWA representative. Users are requested to use the equipment within the range of the specifications and in the manner described in this manual. This manual also describes PROM version NSN620100 and beyond. PROMs of former versions have different arrangements of control constant numbers. For further information, contact your YASKAWA representative.

Email: service@YASKAWA-ELECTRIC-CORPORATION

Line id: @zzzz

www.repairtw.com

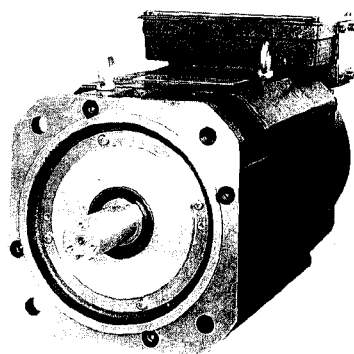

386-79

AC Spindle Motor
Model UAASKA-08DZ1

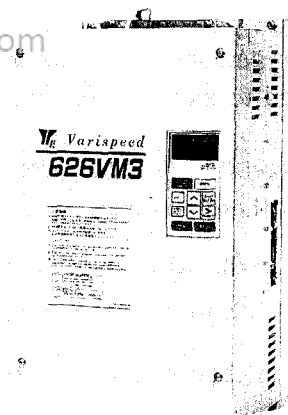

692-308

VS-626VM3 Controller
Model CIMR-VMS27P5

General Precautions

- Some drawings or photos in this manual are shown with the protective cover or shields removed, in order to describe detail with more clarity. Make sure all covers and shields are replaced before operating this product.
- This manual may be modified when necessary because of improvement of the product, modification, or changes in specifications.
Such modifications are denoted by a revised manual No.
- To order a copy of this manual, if your copy has been damaged or lost, contact your YASKAWA representative.
- YASKAWA is not responsible for any modification of the product made by the user, since that will void your guarantee.

NOTES FOR SAFE OPERATION

Read this manual thoroughly before installation, operation, maintenance or inspection of the VS-626VM3. In this manual, NOTES FOR SAFE OPERATION are classified as "WARNING" or "CAUTION".

WARNING

Indicates a potentially hazardous situation which, if not avoided, could result in death or serious injury to personnel.

CAUTION

Indicates a potentially hazardous situation which, if not avoided, may result in minor or moderate injury to personnel and damage to equipment.



It may also be used to alert against unsafe practices.

Even items described in  CAUTION may result in a vital accident in some situations. In either case, follow these important notes.

The following shows the symbols of prohibition and mandatory action.

 PROHIBITION : Specifies prohibited handling.

 MANDATORY ACTION : Specifies actions that must be taken.

This manual also contains precautions for safe use of the equipment. Pay special attention to precautions marked with , , and .

 : Precautions to prevent accidents that may lead to injury.

 : Precautions to prevent accidents that may lead to failure or damage to the equipment.

 : Precautions about installation or wiring conditions to prevent accidents that may lead to failure or damage to the equipment.

<NOTES FOR INVERTER>

RECEIVING

CAUTION

(Ref. page)

- Do not install or operate any inverter which is damaged or has missing parts.
Failure to observe this caution may result in personal injury or equipment damage.140

INSTALLATION

CAUTION

(Ref. page)

- Lift the cabinet by the base. When moving the unit, never lift by the front cover.
Otherwise, the main unit may be dropped causing damage to the unit. 146
- Mount the inverter on nonflammable material (i.e. metal).
Failure to observe this caution can result in a fire. 146
- For open chassis type, install a fan or other cooling device to keep the intake air temperature below 45°C.
Overheating may cause a fire or damage to the unit. 146

Email: service@repairtw.com

Line id: @zzzz

WIRING

WARNING

(Ref. page)

- Only commence wiring after verifying that the power supply is turned OFF.
Failure to observe this warning can result in an electrical shock or a fire. 149
- Wiring should be performed only by qualified personnel.
Failure to observe this warning can result in an electrical shock or a fire.
- When wiring the emergency stop circuit, check the wiring thoroughly before operation.
Failure to observe this warning can result in personal injury. 152
- Make sure to ground the ground terminal \oplus .
(Ground resistance...200V class: 100Ω or less, 400V class: 10Ω or less)
Failure to observe warning can result in an electrical shock or a fire. 51,149

 **CAUTION**

(Ref. page)

- **Verify that the inverter rated voltage coincides with the AC power supply voltage.**
Failure to observe this caution can result in personal injury or a fire.
- **Do not perform a withstand voltage test of the inverter.**
It may cause semi-conductor elements to be damaged.152
- **Make sure to tighten terminal screws.**
Failure to observe this caution can result in a fire.
- **Never connect the AC main circuit power supply to output terminals U, V and W.**
The inverter will be damaged and invalidate the guarantee.152

OPERATION

 **WARNING**

(Ref. page)

- **Only turn ON the input power supply after replacing the front cover or the terminal cover. Do not remove the covers while current is flowing.**
Failure to observe this warning can result in an electrical shock.
- **Never operate the digital operator or the switches when your hand is wet.**
Failure to observe this warning can result in an electrical shock.
- **Never touch the terminals while current is flowing, even during stopping.**
Failure to observe this warning can result in an electrical shock.
- **Since the stop button of the digital operator can be disabled by a function setting, install a separate emergency stop switch.**
Failure to observe this warning can result in personal injury.155

⚠ CAUTION

(Ref. page)

- **Never touch the heatsink or discharging resistor since the temperature is very high.**
Failure to observe this caution can result in harmful burns to the body.
- **Since it is easy to change operation speed from low to high speed, verify the safe working range of the motor and machine before operation.**
Failure to observe this caution can result in personal injury and machine damage.
- **Install a holding brake separately if necessary.**
Failure to observe this caution can result in personal injury.
- **Do not change signals during operation.**
The machine or the inverter may be damaged.
- **All the constants of the inverter have been preset at the factory. Do not change the settings unnecessarily.**
The inverter may be damaged. For common terminal pins of sequence input signals, change the pins according to input method. 55

MAINTENANCE AND INSPECTION

⚠ WARNING

(Ref. page)

- **Never touch high-voltage terminals in the inverter.**
Failure to observe this warning can result in an electrical shock.
- **Perform maintenance or inspection only after verifying that the CHARGE LED goes OFF, after the main circuit power supply is turned OFF.**
The capacitors are still charged and can be dangerous.192
- **Only authorized personnel should be permitted to perform maintenance, inspections or parts replacement.**
[Remove all metal objects (watches, bracelets, etc.) before operation.]
(Use tools which are insulated against electrical shock.)
Failure to observe this warning can result in an electrical shock.

 **CAUTION**

- The control PC board employs CMOS ICs. Do not touch the CMOS elements. The inverter may be damaged by static electricity.
- Do not connect or disconnect wires or connectors while power is applied to the circuit. Failure to observe this caution can result in an electrical shock, personal injury or equipment damage.

OTHERS

 **WARNING**

- Never modify the product.
Failure to observe this warning can result in an electrical shock or personal injury and will invalidate the guarantee.

上正科技有限公司
購買、維修 此手冊零組件
電話： 037-466333
Email: service@repairtw.com
Line id: @zzzz
www.repairtw.com

〈NOTES FOR MOTOR〉

NOTES ON USE

WARNING

Observe the following items to avoid electrical shock or injury. (Ref. page)

- Ground the ground terminals of the inverter and the motor (or ground the metallic part such as frame in case of no ground terminal) according to local and/or national electrical codes.
Failure to observe this warning can result in electrical shock.51,149
- Use grounding wires of a size complying with relevant international or local standards.
- Make wiring length as short as possible. Separate power cables from signal lines.
Noise on signal lines may cause vibration or malfunctions.
- **Disconnect all power and wait 5 minutes before wiring or inspection.**
Failure to observe this warning can result in electrical shock.192
- **Do not damage the cables or apply excess stress; do not place heavy objects on the cables or clamp the cables.**
Failure to observe this warning can result in electrical shock.

電話： 037-466333

Email: service@repairtw.com

Line id: @7777
 CAUTION
www.repairtw.com

(Ref. page)

- Use only the specified combination of the inverter and the motor.
Failure to observe this caution may result in fire or malfunctions.
- Never use at locations exposed to water splashes, corrosive and inflammable gases, or near combustible substances.
Failure to observe this caution may result in fire or malfunctions.31,144
- Use under the following environmental conditions.
 - (1) Indoors where no corrosive or explosive gas exists
 - (2) Well-ventilated without dust or metallic particles
 - (3) Easy to check, clean and maintainFor use at locations where excessive water or oil splashes exist, use a cover or other protection. It is recommended to place the terminal box upward.
- **Do not touch the motor while the power is ON or immediately after turning the power OFF.**
Failure to observe this caution may cause harmful burn.

STORAGE

PROHIBITION

(Ref. page)

- Do not store the equipment in locations where water splashes are present or where there is corrosive gases or liquids.142

MANDATORY ACTION

(Ref. page)

- Store the equipment protected from direct sunlight in the specified range of temperature and humidity. (0°C to + 60°C, 5% to 95% RH)142
- After long time storage, contact your YASKAWA representative.

TRANSPORTATION

購買、維修、組件 CAUTION

電話： 037-466333

(Ref. page)

- Do not lift the cables or the motor shaft when carrying the equipment.
Failure to observe this caution may result in product malfunctions or personal injury.140
- Do not load the products excessively.
Failure to observe this caution may result in collapse of cargo and personal injury.140

MANDATORY ACTION

(Ref. page)

- Use the motor eyebolts exclusively for lifting and transportation of the motor.
Do not attempt to move when other equipment is attached to the motor.140

INSTALLATION

CAUTION

(Ref. page)

- **Do not climb up on the motor or place heavy objects on it.**
Failure to observe this caution may result in personal injury.31,32,33,140,144,145
- **Do not block the air inlet and outlet, and do not let foreign materials enter.**
Failure to observe this caution may result in fire.
- **Do not apply heavy shock.**
Failure to observe this caution may result in a malfunction.
- **When unpacking, be careful of the nails in the wood frame.**
Failure to observe this caution may result in personal injury.
- **Cover the rotary parts so as not to touch them.**
Failure to observe this warning can result in personal injury.
- The motor shaft extension is coated with anticorrosive paint. Before installation, wipe off the paint with a cloth soaked in detergent liquid.
- When connecting the motor to a load machine, be careful with centering, belt tension, and pulley parallelism.
- For coupling with the load machine, use a flexible coupling.
- The motor system is precision equipment. Do not apply shock upon the motor or the motor output shaft. Design machines so that the thrust load and radial load applied to the motor shaft extension during operation should be within the allowable range described in the manual of each model.
- Never make any additional machining to the motor.
- Flange-mounted types must be installed with the load motor output shaft either horizontally or vertically with the shaft down. If the output shaft is to be placed horizontally, place the terminal box upward. Foot-mounted types must be installed on the floor with the foot down. For details, refer to the manual for each model.

WIRING

CAUTION

(Ref. page)

- Perform wiring securely according to the connection diagrams.
Failure to observe this caution may cause motor runaway and personal injury. ..51,149
- Verify that the input power is OFF before wiring.
- Perform proper grounding and noise control.
- Make wiring length as short as possible. Separate the power cables from the signal lines. Do not run power cables and signal lines in the same duct or bundle. Noise on signal lines may cause vibration or malfunctions.
- Never connect commercial power supply directly to the motor.
- Use YASKAWA-specified cables. To use other cables, check the rated current of your equipment, and consider operating environment to select correct cables. If cables not specified by YASKAWA are to be used for the encoder, select twisted-pair shielded wires.
- The terminal block, connectors or connector pin layout differ according to the model. Refer to the manuals for your model before wiring.
- If no terminal block is used, protect lead joints with insulating tubes or tapes.
Failure to observe this caution may result in electrical shock or fire.

OPERATION

電話： 037-466333

Email: service@repairtw.com

Line id:  WARNING

www.repairtw.com

(Ref. page)

- Do not operate the equipment with the terminal box cover removed. After wiring, replace the terminal box cover.
Failure to observe this warning may result in electrical shock.152,177

 **CAUTION**

(Ref. page)

- Perform test run as follows. Secure the motor and disconnect from load machine system, check operations, then connect the motor to the load machine.
Failure to observe this caution may result in personal injury.152,177,183
- If an alarm is issued, correct the cause, verify safety, then reset the alarm and resume operation.
Failure to observe this caution may result in personal injury.202
- If momentary power loss occurs, turn the power supply OFF.
The machine may resume operation suddenly and may result in personal injury.
- Before starting the liquid-cooled motor, verify that cooling oil is properly supplied to the motor.
- For oil mist lubrication type product, verify that the lubrication is properly performed before starting operation.
- Build an emergency stop circuit or a device that protects the motor by immediately stopping operation in case of malfunctions of cooling oil supply or oil mist lubrication.
After emergency stop, restart operation by the following procedure.
 - (1) Recover cooling oil supply or oil mist lubrication.
 - (2) Cool the motor sufficiently (for one hour or longer), then restart operation from low speed.
 - (3) Gradually increase rotation speed while verifying that there is no abnormal noise, increase of vibration or rise in temperatures.

正科特有限公司
購買·維修·此手冊零件
電話：037-466333
Email: service@repairtw.com

Line id: @zzzz

www.repairtw.com

⊘ PROHIBITION

- The brake incorporated in the motor is a holding brake. Do not use it for normal braking.
- Do not operate liquid-cooled motors without supplying cooling oil.
- Do not operate oil mist lubrication motors without supplying proper lubricant.

❗ MANDATORY ACTION

- Build an external emergency stop circuit that immediately stops operation and shuts down power in an emergency.

MAINTENANCE AND INSPECTION

⊘ PROHIBITION

- Only authorized personnel should be permitted to disassemble or repair the equipment.
- If it becomes necessary to disassemble the motor, contact your YASKAWA representative.

電話： 037-466333

Email: service@repairtw.com

Line id: @zzzz

www.repairtw.com

WARNING LABEL

A warning label is displayed on the front cover of the inverter, as shown below. Follow these instructions when handling the inverter.

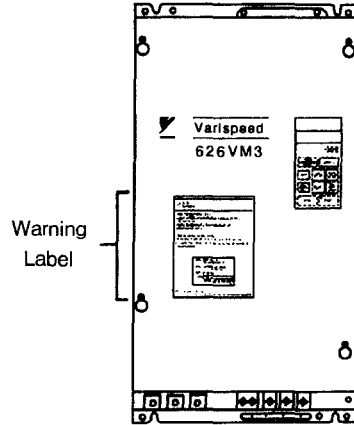

Model CIMR-VMS27P5

上止科技有限公司
 購買、維修 此手冊零組件
 電話：037-466333

Warning Label (Example of Model CIMR-VMS27P5)

⚠ 危険
WARNING

www.repairtw.com

- 据え付け、運転の前には必ず取扱説明書を読んで、その指示に従ってください。
感電のおそれがあります。
- 通電中及び電源遮断後1分以内は、表面カバーを開けないでください。
- 確実に接地を行ってください。

May cause injury or electric shock.

- Please follow the instructions in the manual before installation or operation.
- Disconnect all power before opening front cover of unit. Wait 1 minute until DC Bus capacitors discharge.
- Use proper grounding techniques.

MODEL	CIMR-VMS27P5 200V CLASS INVERTER
INPUT	CA 3PH 200 ~ 220 V/50 Hz 200 ~ 230 V/60 Hz
OUTPUT	AC 3PH 45 A
SPEC	27P5
YASKAWA ELECTRIC CORPORATION JAPAN	

NPIT31127-4-0

CONTENTS

Specifications

1. STANDARD SPECIFICATIONS	19
2. MODEL DESIGNATION	24
3. MOTOR SPECIFICATIONS	25
4. INVERTER SPECIFICATIONS	34
5. OPTIONAL EQUIPMENT AND SPECIFICATIONS	74

Design Manual

6. BASIS OF INVERTER DRIVES	98
7. DESIGN OF VS-626VM3 DRIVE SYSTEM	102
8. APPLICATION DESIGN	118

Startup Manual

9. RECEIVING INSPECTION AND PRE-STORAGE CHECK	140
10. INVERTER PARTS NAMES AND FUNCTIONS	143
11. MOUNTING AND WIRING	144
12. PREPARATION BEFORE STARTING	152
13. OPERATION OF DIGITAL OPERATOR	154
14. DRY RUN	177

Maintenance Manual

15. MAINTENANCE	192
16. TROUBLESHOOTING	202
17. SPARE PARTS	220

Specifications

This section outlines features, functions, and performance of the motor and the inverter of VS-626VM3 Drives, including prohibitions. Read thoroughly before planning basic design.

<ul style="list-style-type: none"> 1. STANDARD SPECIFICATIONS 19 1.1 STANDARD DRIVE SERIES 19 1.2 WINDING SELECTION DRIVE SERIES 21 1.3 PROTECTIVE FUNCTION 23 2. MODEL DESIGNATION 24 2.1 AC SPINDLE MOTOR 24 2.2 INVERTER 24 3. MOTOR SPECIFICATIONS 25 3.1 OUTLINE 25 3.2 CONSTRUCTION 26 3.3 OUTPUT-SPEED CHARACTERISTICS 27 3.3.1 Standard Motors 27 3.3.2 Winding Selection Motors 28 3.4 DIMENSIONS 29 3.4.1 Standard Motors 29 3.4.2 Winding Selection Motors 30 3.5 INSTALLING CONDITIONS 31 3.5.1 Installation Location 31 3.5.2 Installation Orientation 31 3.5.3 Connection with Driven Machine 32 3.6 ENCODER 33 4. INVERTER SPECIFICATIONS 34 4.1 OUTLINE 34 4.2 CONFIGURATION AND FUNCTIONS 36 4.2.1 Equipment Configuration and General Specifications 36 4.2.2 Operation Status Display Functions 37 4.2.3 Protective Functions 37 4.3 CONTROL BLOCK DIAGRAM 39 4.4 DIMENSIONS 40 4.5 INSTALLATION CONDITIONS 43 4.5.1 Installation Location 43 4.5.2 Installation Orientation 44 4.6 STANDARD WIRING DIAGRAM 45 	<ul style="list-style-type: none"> 4.7 WIRING SPECIFICATIONS 48 4.7.1 Power Cables and Terminals 48 4.7.2 Control Power Cable and Motor Cooling Fan Power Cable 49 4.7.3 Control Signal Lines 49 4.7.4 Control Signal Connectors Terminal Assignment 50 4.7.5 Notes on Wiring Power Cables and Control Signal Lines 51 4.8 CONTROL SIGNAL 55 4.8.1 Sequence Input Signal 55 4.8.2 Speed Reference 62 4.8.3 Sequence Output Signal 66 4.8.4 Encoder Pulse Output Circuit 70 4.8.5 Analog Monitor Signal 71 4.9 DIGITAL OPERATOR FUNCTIONS 72 5. OPTIONAL EQUIPMENT AND SPECIFICATIONS 74 5.1 WINDING SELECTION MAGNETIC CONTACTOR 74 5.1.1 Ratings and Specifications 74 5.1.2 Dimensions 75 5.1.3 Status of Operation 75 5.2 MAGNETIC SENSOR ORIENTATION CARD 76 5.2.1 Orientation Specifications 76 5.2.2 Dimensions 77 5.2.3 Connection 79 5.2.4 Control Signal Connector Terminal Layout 80 5.2.5 Installing Magneto and Magnetic Sensor 80 5.2.6 Notes on Mounting 81 5.2.7 Stop Position Reference Input Signal 83 5.3 ENCODER ORIENTATION CARD 84 5.3.1 Orientation Specifications 84
--	---

5.3.2	Dimensions	86
5.3.3	Connections	87
5.3.4	Control Signal Connectors Terminal Assignment	88
5.3.5	Notes on Installing and Wiring of Encoder	89
5.3.6	Stop Position Reference Input Signals	90
5.4	DIGITAL OPERATOR EXTENSION CABLE	91
5.4.1	Adapter Panel and Extension Cable	91
5.4.2	Replacement with the Extension Cable	92
5.5	NOISE FILTER	93
5.5.1	Capacity of Noise Filters	93
5.5.2	Example of Connecting Input Noise Filter	93
5.5.3	Dimensions	94
5.6	I/O SIGNAL CONNECTOR	95
5.6.1	Connector Specifications	95
5.6.2	Dimensions	95

電話： 037-466333

Email: service@repairtw.com

Line id: @zzzz

www.repairtw.com

1. STANDARD SPECIFICATIONS

1.1 STANDARD DRIVE SERIES

Table 1.1 200V Series

Model UAASKA- <input type="text"/> * Z		04	06	08	11	15	19	22	30 [†]	37 [†]
Rated* Output Power	30-minute Rating [†] HP (50%ED) KW (Current)	5 3.7 (32)	7.5 5.5 (39)	10 7.5 (45)	15 11 (62)	20 15 (90)	25 18.5 (96)	30 22 (112)	40 30 (116)	50 37 (216)
	Continuous Rating HP KW (Current)	3 2.2 (23)	5 3.7 (29)	7.5 5.5 (37)	10 7.5 (46)	15 11 (71)	20 15 (82)	25 18.5 (99)	30 22 (131)	40 30 (180)
Rated Speed r/min	Base Speed	1500							1150	
	Maximum Speed	8000			6000			4500		
Output Torque at Base Speed (Continuous Rated Current)	N·m	14.0	23.5	35.0	47.7	70.0	95.0	117.6	182.3	249.0
	lb·ft kgf·m	10.4 1.43	17.4 2.40	25.8 3.57	35.8 4.87	51.7 7.14	70.6 9.74	86.9 12.0	134 18.6	183 25.4
Rotor Inertia ($\frac{GD^2}{4}$)	lb·ft ² kg·m ²	0.90 0.0095	1.99 0.021	2.85 0.030	5.22 0.055	6.88 0.073	9.49 0.10	11.4 0.12	32.1 0.34	9.49 0.40
Rotor GD ²	lb·ft ² kgf·m ²	0.90 0.038	1.99 0.084	2.82 0.12	5.17 0.22	6.87 0.290	9.61 0.404	11.3 0.476	32.1 1.351	37.9 1.60
Overload Capacity	120%, 60s of 30-minute rating (50% ED)									
Vibration	V5							V10		
Noise Level	75dB(A) or below						80dB(A) or below			
Ambient Temperature, Humidity	32 to 104°F (0 to +40°C), 95% RH or below (non-condensing)									
Approx. Mass	lb kg	77 35	121 55	148 67	199 90	232 105	287 130	331 150	574 260	705 320
Model CIMR-VMS2 <input type="text"/>		5P5**	5P5	7P5	011	015	018	022	030	037
Max Required Power Supply	kVA	7	9	12	19	24	30	36	48	60
Power Supply	Three-phase, 200VAC, 50 or 60Hz ; 220VAC, 50 or 60Hz ; 230VAC, 60Hz (Voltage fluctuation : +10 to -15%, frequency fluctuation : ±5%)									
Control Method	Sine wave PWM inverter (Vector control, Power regenerative control)									
Speed Control Range r/min	40 to 8000			40 to 6000			40 to 4500			
Speed Regulation	0.2% maximum speed or below (load variation : 10 to 100%)									
Overload Capacity	120%, 60s of 30-minute rating									
Ambient Temperature	32 to 131°F 0 to +55°C (not frozen)									
Storage Temperature [#]	-4 to 140°F -20 to +60°C									
Humidity	5 to 95% RH (non-condensing)									
Location	Indoor (protected from corrosive gases and dust)									
Vibration	9.8m/s ² (1G) max at 10 to less than 20Hz, 1.96m/s ² (0.2G) max at 20 to 50Hz									
Approx Mass	lb kg	55 26	57 26	60 27	79 36	86 39	106 48	130 59	157 71	159 72

* Rated output power is guaranteed when input voltage is 200V 50/60Hz, 220V 50/60Hz, or 230V 60Hz.

† If input voltage is lower than 200V, rated output power is not guaranteed.

† 15-minute rating (50%ED)/continuous rating for model UAASKA-04* Z 5/3HP(3.7/2.2kW)

‡ This model is for motors of 40/30HP (30/22kW) rated output power.

This model is for motors of 50/40HP (37/30kW) rated output power, UAASKJ-37CZ.

* Inverter model is CIMR-VMS25P5 for motor model UAASKA-04* Z 5/3HP (3.7/2.2kW).

Temperature during shipping (short period).

Table 1.2 400V Series

Model UAASKA- <input type="checkbox"/> *Z***E		04	06	08	11	15	19	22	30 [†]	37 [#]	
		Motor	Rated* Output Power	30-minute Rating [†] (50%ED) HP kW (Current)	5 3.7 (16)	7.5 5.5 (20)	10 7.5 (23)	15 11 (31)	20 15 (45)	25 18.5 (48)	30 22 (56)
Continuous Rating (Current) HP kW	3 2.2 (12)			5 3.7 (15)	7.5 5.5 (19)	10 7.5 (23)	15 11 (36)	20 15 (41)	25 18.5 (50)	30 22 (66)	40 30 (90)
Rated Speed r/min	Base Speed		1500							1150	
	Maximum Speed		8000			6000				4500	
Output Torque at Base Speed (Continuous Rated Current)	N·m		14.0	23.5	35.0	47.7	70.0	95.0	117.6	182.3	249.0
	lb·ft kgf·m		10.4 1.43	17.4 2.40	25.8 3.57	35.8 4.87	51.7 7.14	70.6 9.74	86.9 12.0	134 18.6	183 25.4
Rotor Inertia ($\frac{GD^2}{4}$)	lb·ft ² kg·m ²		0.90 0.0095	1.99 0.021	2.85 0.030	5.22 0.055	6.88 0.073	9.49 0.10	11.4 0.12	32.1 0.34	9.49 0.40
Rotor GD ²	lb·ft ² kgf·m ²		0.90 0.038	1.99 0.084	2.82 0.12	5.17 0.22	6.87 0.290	9.61 0.404	11.3 0.476	32.1 1.351	37.9 1.60
Overload Capacity	120%, 60s of 30-minute rating (50% ED)										
Vibration	V5							V10			
Noise Level	75dB(A) or below					80dB(A) or below					
Ambient Temperature, Humidity	32 to 104°F (0 to +40°C), 95% RH or below (non-condensing)										
Approx. Mass	lb	77	121	148	199	232	287	331	574	705	
	kg	35	55	67	90	105	130	150	260	320	
Model CIMR-VMS4- <input type="checkbox"/>		7P5	7P5	7P5	011	015	018	022	030	037	
Max Required Power Supply kVA		7	9	12	19	24	30	36	48	60	
Power Supply		Three-phase, 400VAC, 50 or 60Hz ; 440VAC, 50 or 60Hz ; 460VAC, 60Hz (Voltage fluctuation : +10 to -15%, frequency fluctuation : ±5%)									
Control Power Supply		Single-phase, 200VAC, 50 or 60Hz ; 220VAC, 50 or 60Hz ; 230VAC, 60Hz (Voltage fluctuation : +10 to -15%, frequency fluctuation : ±5%)									
Control Method		Sine wave PWM inverter (Vector control, Power regenerative control)									
Speed Control Range r/min		40 to 8000			40 to 6000				40 to 4500		
Speed Regulation		0.2% maximum speed or below (load variation : 10 to 100%)									
Overload Capacity		120%, 60s of 30-minute rating									
Ambient Temperature		32 to 131°F 0 to +55°C (not frozen)									
Storage Temperature**		-4 to 140°F -20 to +60°C									
Humidity		5 to 95% RH (non-condensing)									
Location		Indoor (protected from corrosive gases and dust)									
Vibration		9.8m/s ² (1G) max at 10 to less than 20Hz, 1.96m/s ² (0.2G) max at 20 to 50Hz									
Approx Mass	lb	60	60	60	79	86	97	121	143	148	
	kg	27	27	27	36	39	44	55	65	67	

* Rated output power is guaranteed when input voltage is 400V 50/60Hz, 440V 50/60Hz, or 460V 60Hz.

If input voltage is lower than 400V, rated output power is not guaranteed.

[†] 15-minute rating (50%ED)/continuous rating for model UAASKA-04*Z 5/3HP(3.7/2.2kW)

[‡] This model is for motors of 40/30HP (30/22kW) rated output power, UAASKJ-30CZ***E.

[#] This model is for motors of 50/40HP (37/30kW) rated output power, UAASKJ-37CZ***E.

** Temperature during shipping (short period).

1.2 WINDING SELECTION DRIVE SERIES

Table 1.3 200V Series

Model UAASKB- <input type="checkbox"/> CZ		06	08	11†	15	19	22
Rated* Output Power	30-minute Rating (50%ED) (Current) HP kW	7.5 5.5 (34)	10 7.5 (47)	15 11 (68(65))	20 15 (88)	25 18.5 (102)	30 22 (110)
	Continuous Rating (Current) HP kW	5 3.7 (25)	7.5 5.5 (37)	10 7.5 (50(48))	15 11 (67)	20 15 (89)	25 18.5 (99)
Rated Speed r/min	Base Speed	500		500(600)		400	
	Maximum Speed	6000				4800	
Output Torque at Base Speed (Continuous Rated Current)	N•m	71	105	143(119)	262	358	442
	lb•ft kgf•m	52.3 7.21	77.6 10.7	105.9(89.1) 14.5(12.2)	193.6 26.7	264.6 36.5	326.2 45.0
Rotor Inertia ($\frac{GD^2}{4}$)	lb•ft ² kg•m ²	6.88 0.073	9.49 0.10	13.1(11.2) 0.14(0.12)	32.1 0.34	44.9 0.47	52.0 0.55
Rotor GD ²	lb•ft ² kgf•m ²	6.88 0.29	9.49 0.40	13.1(11.4) 0.55(0.48)	32.0 1.35	44.8 1.89	52.0 2.19
Overload Capacity	120%, 60s of 30-minute rating (50% ED)						
Vibration	V5				V10		
Noise Level	75dB(A) or below				80dB(A) or below		
Ambient Temperature, Humidity	32 to 104°F (0 to +40°C), 95% RH or below (non-condensing)						
Approx. Mass	lb kg	232 105	265 120	375(331) 170(150)	574 260	784 355	894 405
Model CIMR-VMW2- <input type="checkbox"/>		5P5	7P5	11P5	15P5	18P5	22P5
Max Required Power Supply	kVA	12	17	19	24	30	36
Power Supply	Three-phase, 200VAC, 50 or 60Hz ; 220VAC, 50 or 60Hz ; 230VAC, 60Hz (Voltage fluctuation : +10 to -15%, frequency fluctuation : ±5%)						
Control Method	Sine wave PWM inverter (Vector control, Power regenerative control)						
Speed Control Range r/min	40 to 6000				40 to 4800		
Speed Regulation	0.2% maximum speed or below (load variation : 10 to 100%)						
Overload Capacity	120%, 60s of 30-minute rating						
Ambient Temperature	32 to 131°F 0 to +55°C (not frozen)						
Storage Temperature‡	-4 to 140°F -20 to +60°C						
Humidity	5 to 95% RH (non-condensing)						
Location	Indoor (protected from corrosive gases and dust)						
Vibration	9.8m/s ² (1G) max at 10 to less than 20Hz, 1.96m/s ² (0.2G) max at 20 to 50Hz						
Approx Mass	lb kg	57 26	60 27	79 36	86 39	106 48	130 59
Magnetic Contactor Model	HV-75AP3				HV-150AP3		

* Rated output power is guaranteed when input voltage is 200V 50/60Hz, 220V 50/60Hz, or 230V 60Hz.

† If input voltage is lower than 200V, rated output power is not guaranteed.

‡ Values in parentheses are for flange-mounted type. Model is UAASKD-11CZ1.

‡ Temperature during shipping (short period).

Table 1.4 400V Series

Model		06	08	11†	15	19	22
UAASKB- <input type="checkbox"/> CZ***E							
Rated* Output Power	30-minute Rating (50%ED) (Current)	HP 5.5 [18]	10 7.5 [24]	15 11 [34(33)]	20 15 [44]	25 18.5 [41]	30 22 [55]
	Continuous Rating (Current)	HP 3.7 [13]	7.5 5.5 [19]	10 7.5 [25(24)]	15 11 [34]	20 15 [45]	25 18.5 [48]
Rated Speed r/min	Base Speed	500		500(600)		400	
	Maximum Speed	6000			4800		
Output Torque at Base Speed (Continuous Rated Current)	N•m	71	105	143(119)	262	358	442
	lb•ft	52.3	77.6	105.9(89.1)	193.6	264.6	326.2
	kgf•m	7.21	10.7	14.5(12.2)	26.7	36.5	45.0
Rotor Inertia ($\frac{GD^2}{4}$)	lb•ft ²	6.88	9.49	13.1(11.2)	32.1	44.9	52.0
	kg•m ²	0.073	0.10	0.14(0.12)	0.34	0.47	0.55
Rotor GD ²	lb•ft ²	6.88	9.49	13.1(11.4)	32.0	44.8	52.0
	kgf•m ²	0.29	0.40	0.55(0.48)	1.35	1.89	2.19
Overload Capacity		120%, 60s of 30-minute rating (50% ED)					
Vibration		V5			V10		
Noise Level		75dB(A) or below			80dB(A) or below		
Ambient Temperature, Humidity		32 to 104°F (0 to +40°C), 95% RH or below (non-condensing)					
Approx. Mass	lb	232	265	375(331)	574	784	894
	kg	105	120	170(150)	260	355	405
Model CIMR-VMW4 <input type="checkbox"/>		7P5	7P5	011	015	018	022
Max Required Power Supply		kVA 9	12	19	24	30	36
Power Supply		Three-phase, 400VAC, 50 or 60Hz ; 440VAC, 50 or 60Hz ; 460VAC, 60Hz (Voltage fluctuation : +10 to -15%, frequency fluctuation : ±5%)					
Control Power Supply		Single-phase, 200VAC, 50 or 60Hz; 220VAC, 50 or 60Hz; 230VAC, 60Hz (Voltage fluctuation: +10 to -15%, frequency fluctuation: ±5%)					
Control Method		Sine wave PWM inverter (Vector control, Power regenerative control)					
Speed Control Range r/min		40 to 6000			40 to 4800		
Speed Regulation		0.2% maximum speed or below (load variation : 10 to 100%)					
Overload Capacity		120%, 60s of 30-minute rating					
Ambient Temperature		32 to 131°F 0 to +55°C (not frozen)					
Storage Temperature‡		-4 to 140°F -20 to +60°C					
Humidity		5 to 95% RH (non-condensing)					
Location		Indoor (protected from corrosive gases and dust)					
Vibration		9.8m/s ² (1G) max at 10 to less than 20Hz, 1.96m/s ² (0.2G) max at 20 to 50Hz					
Approx Mass	lb	60	60	79	86	106	130
	kg	27	27	36	39	48	59
Magnetic Contactor Model		HV-75AP3			HV-150AP3		

* Rated output power is guaranteed when input voltage is 400V 50/60Hz, 440V 50/60Hz, or 460V 60Hz.

If input voltage is lower than 400V, rated output power is not guaranteed.

† Values in parentheses are for flange-mounted type. Model is UAASKD-11CZ1 * * E.

‡ Temperature during shipping (short period).

1.3 PROTECTIVE FUNCTION

Table 1.5 Protective Function

Applicable Equipment	Protective Function	Content	Failure Indication
System	Winding selection wrong	Winding selection is not completed within setting time.†	F000
	Excessive speed fluctuation	Actual speed becomes less than 50% of command speed (excluding actual speed at accel / decel)	F800
	Speed detection signal fault	Disconnection or poor connection of motor encoder lead.	FC00
	Power supply fault	Synchronous power signal loss (at turning on power supply)	F600
		Low-voltage (85% or less), momentary power loss of 0.02s, power loss or open phase.	F602
		Low-voltage (150VAC or less) of control circuit power, power loss.	F604
	Power supply frequency fault	Frequency selection impossible (50/60Hz) at turning on power supply.	F601
		Power frequency fluctuation exceeds $\pm 5\%$ of rated value.	F603
	Excessive inverter temperature rise in control cabinet	Temperature in cabinet becomes $+55^{\circ}\text{C}$ or above.	F906
		Temperature in cabinet becomes $+60^{\circ}\text{C}$ or above.	F907
Inverter*	Control function fault	IC fault	CPF00
	Emergency stop fault	Motor does not stop within 10 seconds after emergency stop command output.	F001
	Excessive output current	Inverter output current exceeds the set value.†	F100
	Excessive input current	Inverter output current exceeds the set value.†	F300
	Built-in MC fault	MC of inverter input section does not operate.	F200
	MCCB trip	MCCB of inverter input section trips.	F201
	Inverter overload	Inverter output current exceeds 120% of 30-minute rating for 1 minute or over.	F700
		Inverter input current exceeds 120% of 30-minute rating for 1 minute or over.	F701
	Inverter overvoltage	Inverter DC bus voltage exceeds the overvoltage set value.†	F400
	Excessive heat sink temperature	Heat sink temperature exceeds the set value.†	F903
		Heat sink temperature exceeds the set value for 1 minute or over.	F904
Heat sink temperature detect thermistor is disconnected.		F905	
Initial charge fault	Main capacitor is not charged within the set time.†	FA00	
Motor	Over speed	Motor temperature exceeds the allowable temperature-rise limit.	F500
	Excessive temperature-rise	Motor temperature exceeds the allowable temperature-rise limit.	F900
		Motor temperature exceeds the allowable temperature-rise limit for 4 minutes or over.	F901
		Motor temperature detect thermistor is disconnected.	F902

* For protect function for hardware/software inverter, see Par. 13.5.

† Set time and set value differ from inverter capacity. They are preset before shipment.

‡ Set rated speed is at speed command 10V and be set to C1-26.

It can be set in the range from 100r/min to the motor max speed.

The temperature-rise limit is of the specified value in JIS C4004.

For motor insulation class F, the value is 155°C .

Overheat is detected in one minute or more for PROM version NSN620148 and beyond.

2. MODEL DESIGNATION

2.1 AC SPINDLE MOTOR

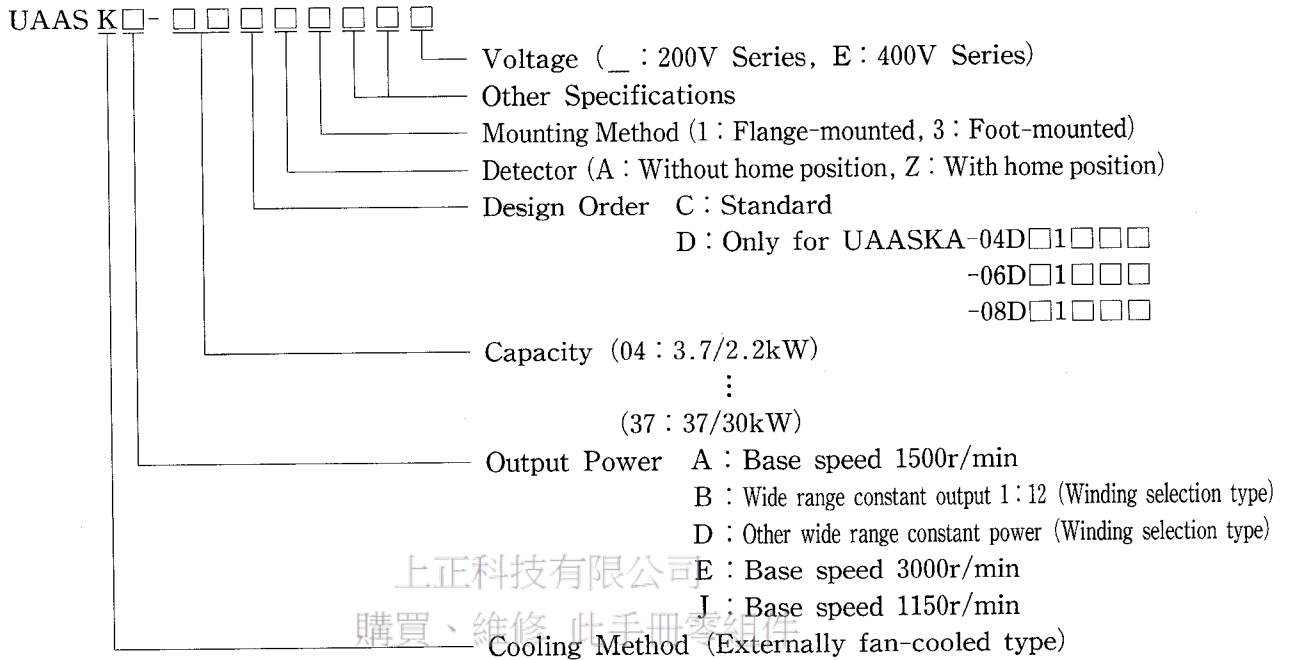

2.2 INVERTER

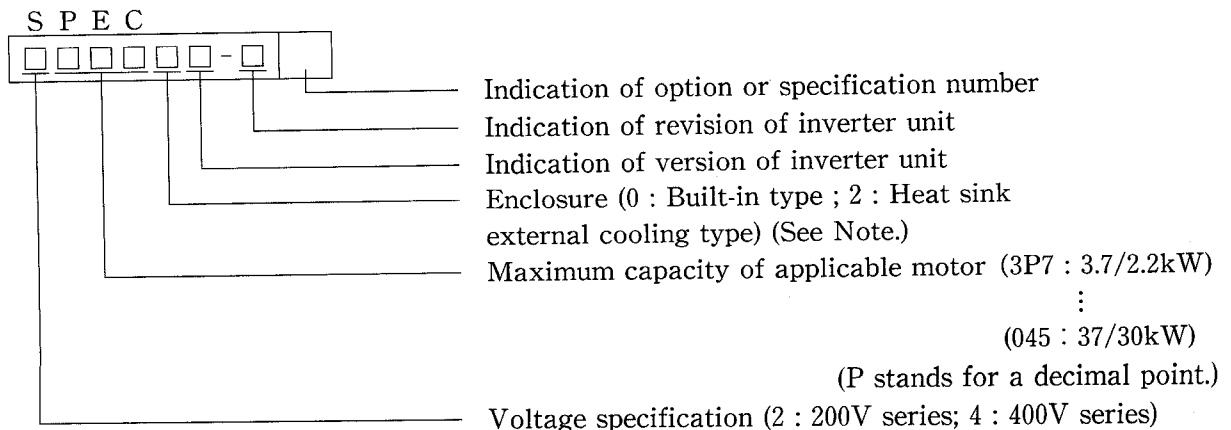
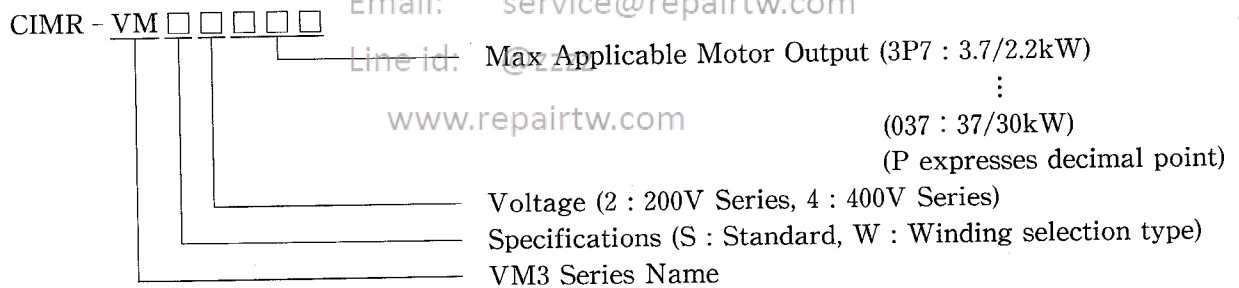

Note: The built-in type is mounted directly on the side or back of the control panel using the heat sink cover on the back of the inverter. The heat sink external cooling type is mounted with the heat sink exposed to the outside by drilling / cutting a hole of specified dimensions in the control panel. To use this type, an air duct must be prepared for cooling the heat sink.

3. MOTOR SPECIFICATIONS

3.1 OUTLINE

AC spindle motors are squirrel-cage induction motors suitable for high-speed driving of the spindle of NC machine tools or other manufacturing equipment. Flange- and foot- mounted types can be selected for ease of installing onto the load machine. The motors have the following features:

(1) Wide range of constant output

With precision bearings and highly rigid frame design, motors of 7.5 kW or lower are operable up to 8000 r/min (constant output range: 1 : 5.3). Motors that are 11 kW or greater are operable up to 6000 r/min (constant output range: 1 : 4). Winding selection motors cover a broader constant output range, and offer a constant output ratio of 1 : 12 without using speed change gear. Compact magnetic contactors having a transfer contact structure specialized for winding selection are provided. For detailed specifications of the magnetic contactors, see Section 5, "Optional Equipment and Specifications."

(2) Low vibration

The motors are compact and dynamically balanced so as to reduce vibration even during high-speed driving.

(3) High reliability

The motors are totally-enclosed self-cooled type. The speed detectors are highly reliable 1024 P/R magnetic encoders.

(4) Cooling system

In all motors, cooling air enters from the load machine side and exits from the opposite side, avoiding exposure of the machine to the exhaust. If opposite air direction is preferred because of machine configuration, the cooling structure can be changed accordingly.

(5) 400 V series

Dimensions of the new series are the same as the 200 V standard series. However, motor cooling fan is 200 V class.

3.2 CONSTRUCTION

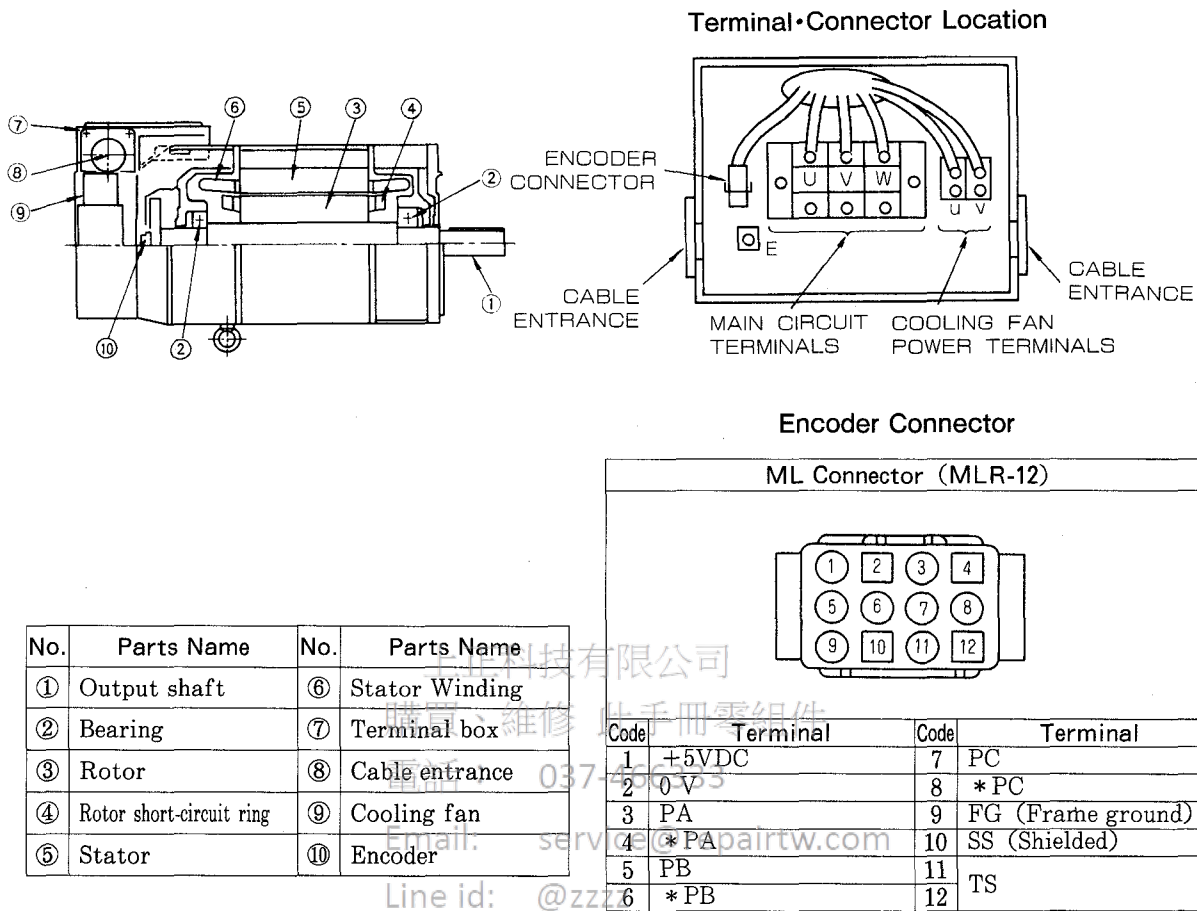

Fig. 3.1 Motor Construction Encoder with home position encoder

Table 3.1 General Specifications of Motor

Insulation	Class F
Cooling Fan	Motor for fan use; capacitor motor Single-phase, 200V, 50 or 60Hz; 220V, 50 or 60Hz; 230V, 60Hz
Overheat Protection	NTC thermister
Speed Detector	Magnetic encoder
Installing Detection	From horizontal to vertical (Place output shaft down)
Bearing Lubricating Method	Grease
Paint Color	Munsell notation N1.5
Ambient Temperature	0 ~ +40°C, 32 to 104°F
Humidity	95%RH or below (non-condensing)
Altitude	1000m or below
Isolation Voltage	1500VAC, one minute
Insulation Resistance	500VDC, 10MΩ or more
Standards	JIS*, JEC†

* JIS: Japanese Industrial Standard

† JEC: Standard of Japanese Electrotechnical Committee

3.3 OUTPUT-SPEED CHARACTERISTICS

3.3.1 Standard Motors

(1) 3.7/2.2kW (5/3HP)

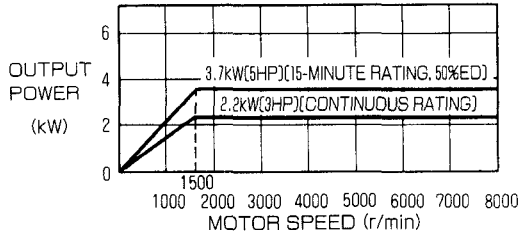

(5) 15/11kW (20/15HP)

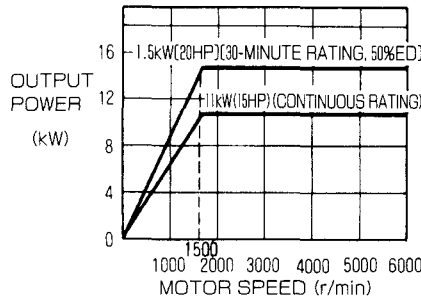

(9) 37/30kW (50/40HP)

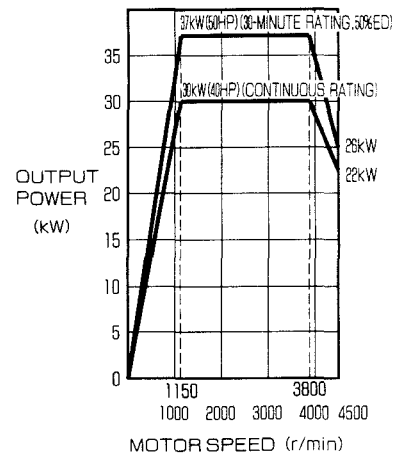

(2) 5.5/3.7kW (7.5/5HP)

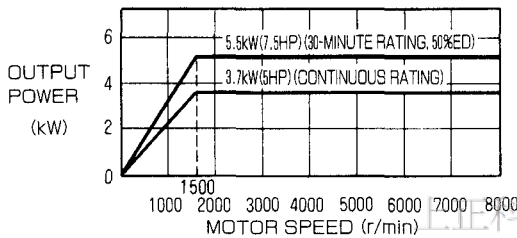

(6) 18.5/15kW (25/20HP)

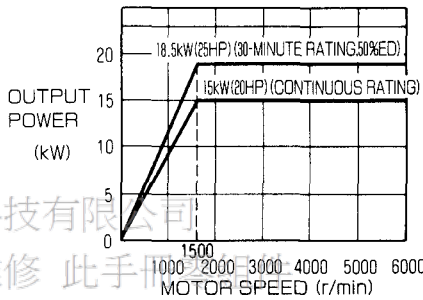

(3) 7.5/5.5kW (10/7.5HP)

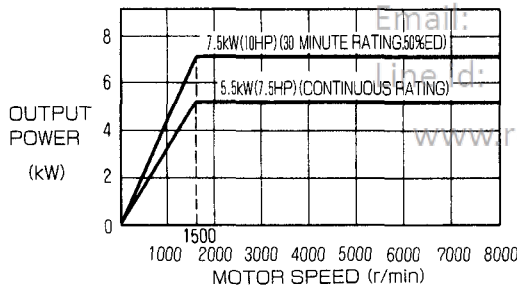

(7) 22/18.5kW (30/25HP)

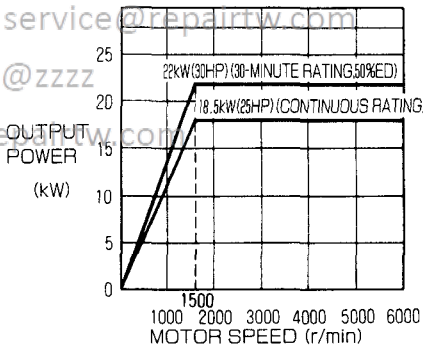

(4) 11/7.5kW (15/10HP)

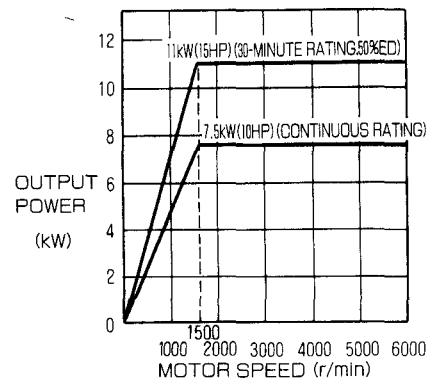

(8) 30/22kW (40/30HP)

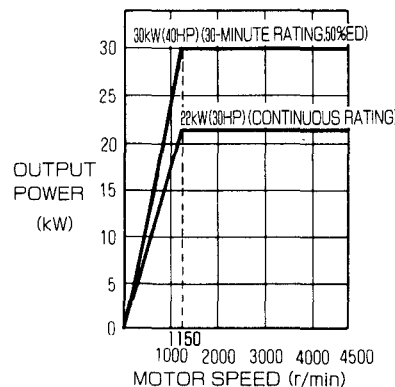

Note: Output characteristics are the same both 200V series and 400V series

Fig. 3.2 Output-Speed Characteristics

3.3.2 Winding Selection Motors

(1) 5.5/3.7kW (7.5/5HP)

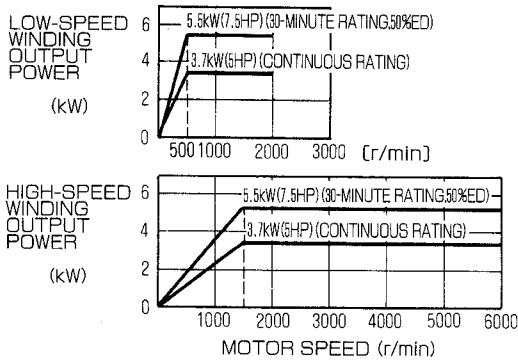

(4) 15/11kW (20/15HP)

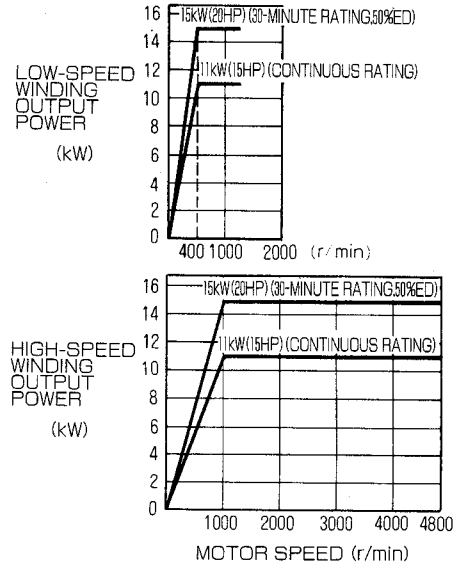

(2) 7.5/5.5kW (10/7.5HP)

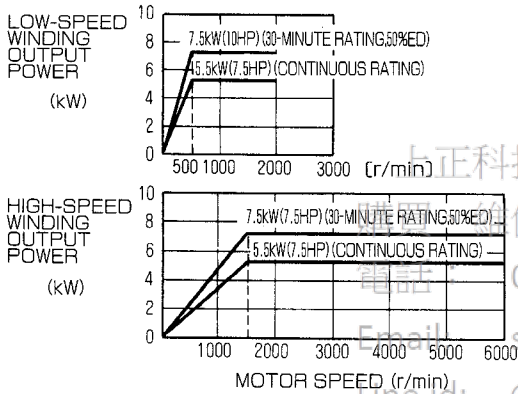

(5) 18.5/15kW (25/20HP)

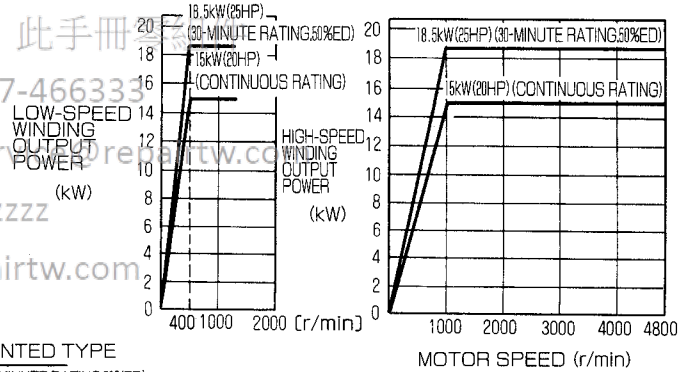

(3) 11/7.5kW (15/10HP)

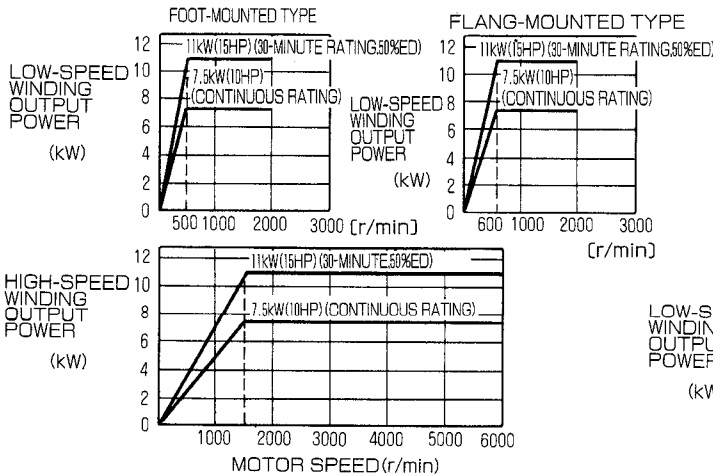

(6) 22/18.5kW (30/25HP)

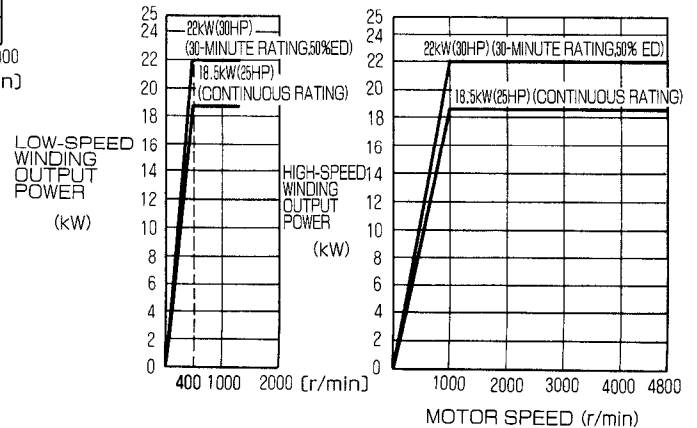

Note: Output characteristics are the same both 200V series and 400V series

Fig. 3.3 Output-Speed Characteristics (Winding Selection Motors)

3.4 DIMENSIONS in mm (in inches)

3.4.1 Standard Motors

• Foot-Mounted Type

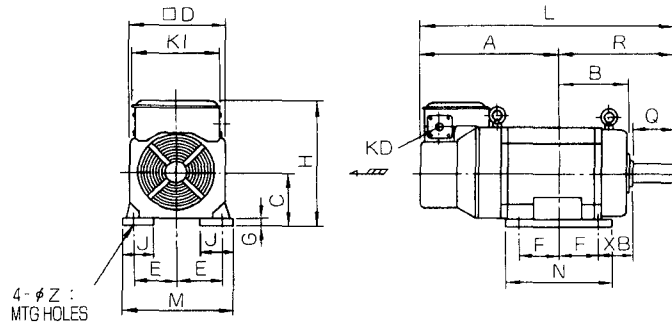

Detail of Shaft Extension

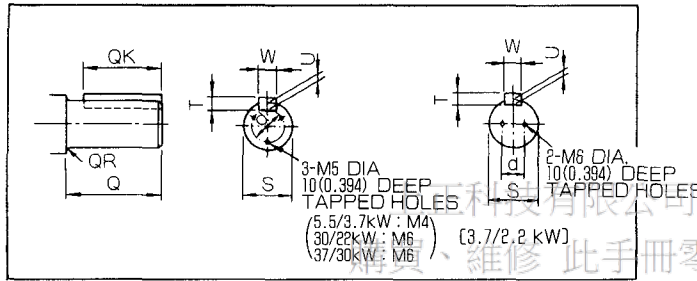

• Flange-mounted Type

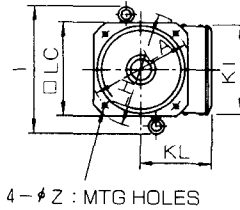
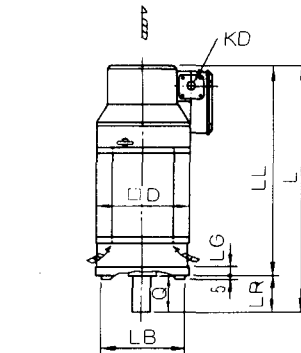

FOOT-MOUNTED TYPE

Rated Output kW (HP)	30-min Rating	Continuous Rating	Shaft Extension																								
			A	B	C _{2-0.5} (C _{0.02})	D	E	F	G	H	J	KD	L	M	N	R	XB	Z	KI	Q	QK	QR	S	T	U	W	d
3.7*	(5)	2.2 (3)	251 (9.88)	93 (3.66)	100 (3.94)	174 (6.85)	80 (3.15)	50 (1.97)	9	241 (9.49)	34 (1.34)	34 (1.34)	406 (15.98)	188 (7.40)	125 (4.92)	155 (6.10)	45 (1.77)	12 (0.47)	174 (6.85)	60 (2.36)	45 (1.77)	1 (0.04)	28 ^{+0.009} _{-0.004} (1.1024 ^{+0.0022} _{-0.0011})	7 (0.28)	4 (0.16)	8 (0.31)	16 (0.63)
5.5 (7.5)	3.7 (5)	262 (10.31)	117 (4.61)	112 (4.41)	204 (8.03)	95 (3.74)	50 (1.97)	10	267 (10.51)	75 (2.95)	42 (1.67)	442 (17.40)	220 (8.66)	129 (5.08)	180 (7.09)	70 (2.76)	12 (0.47)	204 (8.03)	60 (2.36)	45 (1.77)	1 (0.04)	28 ^{+0.013} _{-0.003} (1.1024 ^{+0.0033} _{-0.0003})	7 (0.28)	4 (0.16)	8 (0.31)	22 (0.87)	
7.5 (10)	5.5 (7.5)	290 (11.42)	137 (5.39)	112 (4.41)	204 (8.03)	95 (3.74)	70 (2.76)	10	267 (10.51)	75 (2.95)	42.5 (1.67)	510 (20.08)	220 (8.66)	177 (6.97)	220 (8.66)	70 (2.76)	12 (0.47)	204 (8.03)	80 (3.15)	70 (2.76)	1 (0.04)	32 ^{+0.016} _{-0.006} (1.2598 ^{+0.0040} _{-0.0016})	8 (0.31)	5 (0.20)	10 (0.39)	22 (0.87)	
11 (15)	7.5 (10)	230 (9.06)	176 (6.93)	160 (6.30)	250 (9.84)	127 (5.00)	70 (2.76)	16	340 (13.39)	50 (1.97)	42.5 (1.67)	518 (20.39)	290 (11.42)	206 (8.11)	288 (11.34)	108 (4.25)	15 (0.59)	250 (9.84)	110 (4.33)	90 (3.54)	0.5 (0.02)	48 ^{+0.016} _{-0.006} (1.8898 ^{+0.0040} _{-0.0016})	9 (0.35)	5.5 (0.22)	14 (0.55)	40 (1.57)	
15 (20)	11 (15)	249 (9.80)	195 (7.68)	160 (6.30)	250 (9.84)	127 (5.00)	89 (3.50)	16	340 (13.39)	50 (1.97)	42.5 (1.67)	556 (21.89)	290 (11.42)	244 (9.61)	307 (12.09)	108 (4.25)	15 (0.59)	250 (9.84)	110 (4.33)	90 (3.54)	0.5 (0.02)	48 ^{+0.016} _{-0.006} (1.8898 ^{+0.0040} _{-0.0016})	9 (0.35)	5.5 (0.22)	14 (0.55)	40 (1.57)	
18.5 (25)	15 (20)	304 (11.97)	211 (8.31)	160 (6.30)	250 (9.84)	127 (5.00)	105 (4.13)	16	360 (14.17)	55 (2.17)	42.5 (1.67)	627 (24.69)	290 (11.42)	278 (10.94)	323 (12.72)	108 (4.25)	15 (0.59)	250 (9.84)	110 (4.33)	90 (3.54)	0.5 (0.02)	48 ^{+0.016} _{-0.006} (1.8898 ^{+0.0040} _{-0.0016})	9 (0.35)	5.5 (0.22)	14 (0.55)	40 (1.57)	
22 (30)	18.5 (25)	318 (12.52)	233 (9.17)	160 (6.30)	250 (9.84)	127 (5.00)	127 (5.00)	16	360 (14.17)	55 (2.17)	42.5 (1.67)	663 (26.10)	320 (12.60)	320 (12.60)	345 (13.58)	108 (4.25)	15 (0.59)	250 (9.84)	110 (4.33)	90 (3.54)	0 (0)	55 ^{+0.016} _{-0.006} (2.1654 ^{+0.0040} _{-0.0016})	10 (0.39)	6 (0.24)	16 (0.63)	45 (1.77)	
30 (40)	22 (30)	442 (17.40)	246 (9.69)	180 (7.09)	310 (12.20)	139.5 (5.49)	127 (5.00)	16	432 (17.01)	55 (2.17)	61 (2.40)	830 (32.68)	320 (12.60)	390 (15.35)	388 (15.28)	121 (4.76)	19 (0.75)	330 (13.00)	140 (5.51)	110 (4.33)	2 (0.08)	60 ^{+0.016} _{-0.006} (2.3622 ^{+0.0040} _{-0.0016})	11 (0.43)	7 (0.28)	18 (0.71)	50 (1.97)	
37 (50)	30 (40)	365 (14.37)	273 (10.75)	225 (8.86)	380 (14.96)	178 (7.01)	127 (5.00)	21	505 (19.88)	75 (2.95)	61 (2.40)	781 (30.75)	420 (16.54)	370 (14.57)	416 (16.38)	149 (5.87)	24 (0.94)	385 (15.16)	140 (5.51)	110 (4.33)	1 (0.04)	70 ^{+0.016} _{-0.006} (2.7559 ^{+0.0040} _{-0.0016})	12 (0.47)	7.5 (0.30)	20 (0.79)	60 (2.36)	

* 15-minute rating (50% ED) / continuous rating. Not furnished with eyebolts for 3.7/2.2kW unit.

FLANGE-MOUNTED TYPE

Rated Output kW (HP)	30-min Rating	Continuous Rating	Shaft Extension																							
			L	LA	LB	LC	LG	LH	LL	LR	Z	D	I	KD	KL	KI	Q	QK	QR	S	T	U	W	d		
3.7*	(5)	2.2 (3)	424 (16.70)	185 (7.28)	150 ^{+0.006} _{-0.0014} (5.9055 ^{+0.0014} _{-0.0003})	174 (6.85)	15 (0.59)	220 (8.66)	364 (14.33)	36 (1.43)	11 (0.43)	174 (6.85)	—	34 (1.34)	141 (5.55)	174 (6.85)	60 (2.36)	45 (1.77)	1 (0.04)	28 ^{+0.009} _{-0.004} (1.1024 ^{+0.0022} _{-0.0011})	7 (0.28)	4 (0.16)	8 (0.31)	16 (0.63)		
5.5 (7.5)	3.7 (5)	450 (18.07)	215 (8.46)	180 ^{+0.006} _{-0.0014} (7.0866 ^{+0.0014} _{-0.0003})	204 (8.03)	17 (0.67)	250 (9.84)	399 (15.71)	60 (2.36)	15 (0.59)	204 (8.03)	270 (10.63)	42.5 (1.67)	155 (6.10)	204 (8.03)	60 (2.36)	45 (1.77)	1 (0.04)	28 ^{+0.013} _{-0.003} (1.1024 ^{+0.0033} _{-0.0003})	7 (0.28)	4 (0.16)	8 (0.31)	22 (0.87)			
7.5 (10)	5.5 (7.5)	527 (20.75)	215 (8.46)	180 ^{+0.006} _{-0.0014} (7.0866 ^{+0.0014} _{-0.0003})	204 (8.03)	17 (0.67)	250 (9.84)	447 (17.60)	80 (3.15)	15 (0.59)	204 (8.03)	270 (10.63)	42.5 (1.67)	155 (6.10)	204 (8.03)	80 (3.15)	70 (2.76)	1 (0.04)	32 ^{+0.016} _{-0.006} (1.2598 ^{+0.0040} _{-0.0016})	8 (0.31)	5 (0.20)	10 (0.39)	22 (0.87)			
11 (15)	7.5 (10)	514 (20.24)	265 (10.43)	220 ^{+0.006} _{-0.0014} (8.6951 ^{+0.0014} _{-0.0003})	250 (9.84)	18 (0.71)	300 (11.81)	404 (15.91)	110 (4.33)	15 (0.59)	250 (9.84)	335 (13.19)	42.5 (1.67)	180 (7.09)	250 (9.84)	110 (4.33)	90 (3.54)	0.5 (0.02)	48 ^{+0.016} _{-0.006} (1.8898 ^{+0.0040} _{-0.0016})	9 (0.35)	5.5 (0.22)	14 (0.55)	40 (1.57)			
15 (20)	11 (15)	552 (21.73)	265 (10.43)	220 ^{+0.006} _{-0.0014} (8.6951 ^{+0.0014} _{-0.0003})	250 (9.84)	18 (0.71)	300 (11.81)	442 (17.40)	110 (4.33)	15 (0.59)	250 (9.84)	335 (13.19)	42.5 (1.67)	180 (7.09)	250 (9.84)	110 (4.33)	90 (3.54)	0.5 (0.02)	48 ^{+0.016} _{-0.006} (1.8898 ^{+0.0040} _{-0.0016})	9 (0.35)	5.5 (0.22)	14 (0.55)	40 (1.57)			
18.5 (25)	15 (20)	626 (24.65)	265 (10.43)	220 ^{+0.006} _{-0.0014} (8.6951 ^{+0.0014} _{-0.0003})	250 (9.84)	18 (0.71)	300 (11.81)	516 (20.31)	110 (4.33)	15 (0.59)	250 (9.84)	335 (13.19)	42.5 (1.67)	200 (7.87)	250 (9.84)	110 (4.33)	90 (3.54)	0.5 (0.02)	48 ^{+0.016} _{-0.006} (1.8898 ^{+0.0040} _{-0.0016})	9 (0.35)	5.5 (0.22)	14 (0.55)	40 (1.57)			
22 (30)	18.5 (25)	674 (26.54)	265 (10.43)	220 ^{+0.006} _{-0.0014} (8.6951 ^{+0.0014} _{-0.0003})	250 (9.84)	20 (0.79)	300 (11.81)	564 (22.20)	110 (4.33)	15 (0.59)	250 (9.84)	335 (13.19)	42.5 (1.67)	200 (7.87)	250 (9.84)	110 (4.33)	90 (3.54)	0 (0)	55 ^{+0.016} _{-0.006} (2.1654 ^{+0.0040} _{-0.0016})	10 (0.39)	6 (0.24)	16 (0.63)	45 (1.77)			
30 (40)	22 (30)	875 (34.45)	350 (13.78)	300 ^{+0.006} _{-0.0014} (11.8110 ^{+0.0014} _{-0.0003})	320 (12.60)	20 (0.79)	385 (15.16)	735 (28.94)	140 (5.51)	19 (0.75)	310 (12.20)	432 (17.01)	61 (2.40)	390 (15.35)	388 (15.28)	121 (4.76)	25 (0.99)	330 (13.00)	140 (5.51)	110 (4.33)	2 (0.08)	60 ^{+0.016} _{-0.006} (2.3622 ^{+0.0040} _{-0.0016})	11 (0.43)	7 (0.28)	18 (0.71)	50 (1.97)
37 (50)	30 (40)	780 (30.71)	400 (15.75)	350 ^{+0.006} _{-0.0014} (13.7795 ^{+0.0014} _{-0.0003})	370 (14.57)	22 (0.87)	450 (17.72)	640 (25.20)	140 (5.51)	24 (0.94)	380 (14.96)	505 (19.88)	61 (2.40)	420 (16.54)	416 (16.38)	149 (5.87)	24 (0.94)	385 (15.16)	140 (5.51)	110 (4.33)	1 (0.04)	70 ^{+0.016} _{-0.006} (2.7559 ^{+0.0040} _{-0.0016})	12 (0.47)	7.5 (0.30)	20 (0.79)	60 (2.36)

* 15-minute rating (50% ED) / continuous rating. Not furnished with eyebolts for 3.7/2.2kW unit.

Note: Dimensions of the shaft extension key and keyway are based on JIS (Japanese Industrial Standard) B 1301-1996.

3.4.2 Winding Selection Motors

• Foot-mounted Type

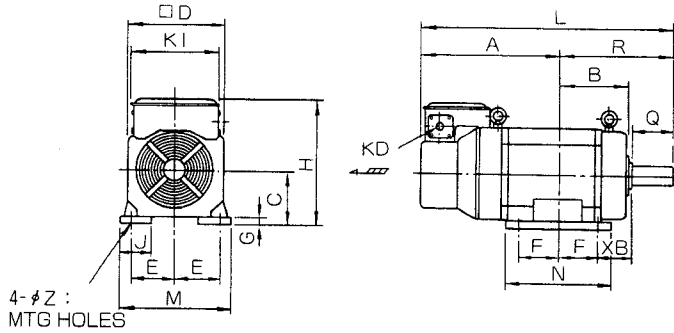

• Flange-mounted Type

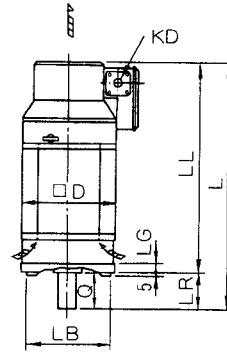

Detail of Shaft Extension

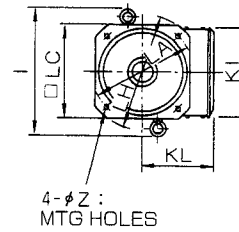
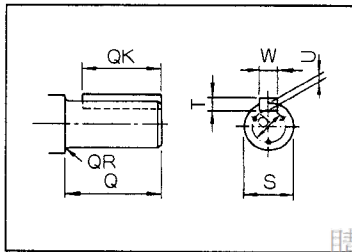

上正科技有限公司
 購買、維修 此手冊零組件
 電話： 037-466333

FOOT-MOUNTED TYPE

Email: service@repairtw.com

	Rated Output kW (HP)		A	B	C ^{±0.05} (-0.02)	D	E	F	G	H	J	KD	L	M	N	R	XB	Z	KI	Shaft Extension							
	30-min Rating	Continuous Rating																		Q	QK	QR	S	T	U	W	d
Standard	5.5 (7.5)	3.7 (5.5)	249 (9.80)	195 (7.68)	160 (6.30)	250 (9.84)	127 (5.00)	89 (3.50)	16 (0.63)	340 (13.39)	55 (2.17)	42.5 (1.67)	556 (21.89)	290 (11.42)	244 (9.61)	307 (12.09)	108 (4.25)	15 (0.59)	320 (12.60)	110 (4.33)	90 (3.54)	0.5 (0.02)	48 (1.8898)	9 (0.35)	5.5 (0.22)	14 (0.55)	40 (1.57)
	7.5 (10)	5.5 (7.5)	271 (10.67)	211 (8.31)	160 (6.30)	250 (9.84)	127 (5.00)	105 (4.13)	16 (0.63)	340 (13.39)	55 (2.17)	42.5 (1.67)	594 (23.39)	290 (11.42)	278 (10.94)	323 (12.72)	108 (4.25)	15 (0.59)	320 (12.60)	110 (4.33)	90 (3.54)	0.5 (0.02)	48 (1.8898)	9 (0.35)	5.5 (0.22)	14 (0.55)	40 (1.57)
	11 (15)	7.5 (10)	300.5 (11.83)	258.5 (10.18)	160 (6.30)	250 (9.84)	127 (5.00)	152.5 (6.00)	16 (0.63)	340 (13.39)	55 (2.17)	42.5 (1.67)	611 (26.49)	290 (11.42)	375 (14.76)	370.5 (14.59)	108 (4.25)	15 (0.59)	320 (12.60)	110 (4.33)	90 (3.54)	0 (0)	55 (2.1654)	10 (0.39)	5 (0.24)	16 (0.63)	45 (1.77)
	15 (20)	11 (15)	442 (17.40)	246 (9.69)	180 (7.09)	310 (12.20)	139.5 (5.49)	127 (5.00)	16 (0.63)	432 (17.01)	55 (2.17)	61 (2.40)	830 (32.68)	320 (12.60)	390 (15.35)	388 (15.28)	121 (4.76)	19 (0.75)	530 (20.87)	140 (5.51)	110 (4.33)	2 (0.08)	60 (2.3622)	11 (0.43)	7 (0.28)	18 (0.71)	50 (1.97)
	18.5 (25)	15 (20)	385.5 (15.18)	303 (11.89)	225 (8.86)	380 (14.96)	178 (7.01)	155.5 (6.12)	21 (0.83)	505 (19.96)	75 (2.95)	61 (2.40)	830 (32.68)	420 (16.54)	425 (16.73)	444.5 (17.50)	149 (5.87)	24 (0.94)	385 (15.16)	140 (5.51)	110 (4.33)	1 (0.04)	70 (2.756)	12 (0.47)	7.5 (0.30)	20 (0.79)	60 (2.36)
	22 (30)	18.5 (25)	416.5 (16.40)	321 (12.64)	225 (8.86)	380 (14.96)	178 (7.01)	174.5 (6.87)	21 (0.83)	505 (19.96)	75 (2.95)	61 (2.40)	880 (34.65)	420 (16.54)	465 (18.31)	463.5 (18.25)	149 (5.87)	24 (0.94)	385 (15.16)	140 (5.51)	110 (4.33)	1 (0.04)	70 (2.756)	12 (0.47)	7.5 (0.30)	20 (0.79)	60 (2.36)

FLANGE-MOUNTED TYPE

	Rated Output kW (HP)		L	LA	LB	LC	LG	LH	LL	LR	Z	D	I	KD	KL	KI	Shaft Extension							
	30-min Rating	Continuous Rating															Q	QK	QR	S	T	U	W	d
Standard	5.5 (7.5)	3.7 (5.5)	555 (21.85)	365 (14.43)	290 ^{±0.046} (9.0551)	250 ^{±0.046} (9.84)	18 (0.71)	300 (11.81)	445 (17.52)	110 (4.33)	15 (0.59)	250 (9.84)	335 (13.19)	42.5 (1.67)	180 (7.09)	320 (12.60)	110 (4.33)	90 (3.54)	0.5 (0.02)	48 (1.8898)	9 (0.35)	5.5 (0.22)	14 (0.55)	40 (1.57)
	7.5 (10)	5.5 (7.5)	593 (23.35)	265 (10.43)	230 ^{±0.046} (9.0551)	250 ^{±0.046} (9.84)	18 (0.71)	300 (11.81)	483 (19.02)	110 (4.33)	15 (0.59)	250 (9.84)	335 (13.19)	42.5 (1.67)	180 (7.09)	320 (12.60)	110 (4.33)	90 (3.54)	0.5 (0.02)	48 (1.8898)	9 (0.35)	5.5 (0.22)	14 (0.55)	40 (1.57)
	11 (15)	7.5 (10)	641 (25.24)	265 (10.43)	230 ^{±0.046} (9.0551)	250 ^{±0.046} (9.84)	20 (0.79)	300 (11.81)	531 (20.91)	110 (4.33)	15 (0.59)	250 (9.84)	335 (13.19)	42.5 (1.67)	180 (7.09)	320 (12.60)	110 (4.33)	90 (3.54)	0 (0)	55 (2.1654)	10 (0.39)	5 (0.24)	16 (0.63)	45 (1.77)
	15 (20)	11 (15)	875 (34.45)	350 (13.78)	300 ^{±0.052} (9.5181)	320 ^{±0.052} (12.60)	20 (0.79)	385 (15.16)	735 (28.94)	140 (5.51)	19 (0.75)	310 (12.20)	432 (17.01)	61 (2.40)	252 (9.92)	330 (13.00)	140 (5.51)	110 (4.33)	2 (0.08)	60 (2.3622)	11 (0.43)	7 (0.28)	18 (0.71)	50 (1.97)
	18.5 (25)	15 (20)	830 (32.68)	400 (15.75)	360 ^{±0.057} (13.775)	370 ^{±0.057} (14.57)	22 (0.87)	450 (17.72)	890 (34.97)	140 (5.51)	24 (0.94)	380 (14.96)	495 (19.49)	61 (2.40)	280 (11.02)	385 (15.16)	140 (5.51)	110 (4.33)	1 (0.04)	70 (2.756)	12 (0.47)	7.5 (0.30)	20 (0.79)	60 (2.36)
	22 (30)	18.5 (25)	880 (34.65)	400 (15.75)	360 ^{±0.057} (13.775)	370 ^{±0.057} (14.57)	22 (0.87)	450 (17.72)	740 (29.13)	140 (5.51)	24 (0.94)	380 (14.96)	495 (19.49)	61 (2.40)	280 (11.02)	385 (15.16)	140 (5.51)	110 (4.33)	1 (0.04)	70 (2.756)	12 (0.47)	7.5 (0.30)	20 (0.79)	60 (2.36)

Note: Dimensions of the shaft extension key and keyway are based on JIS (Japanese Industrial Standard) B 1301-1996.

3.5 INSTALLING CONDITIONS

The following requirements should be considered when designing a machine structure around the motor. (Refer to Para.11.1.3.)

3.5.1 Installation Location

- (1) Sufficient cooling air must be supplied to the cooling fan. The motor opposite drive end (where cooling air is exhausted) must be separated from machines by 100mm or more.
 - ★ - If supplied air is insufficient, motor thermal error protection may be activated even under loads within the rating.
- (2) The motor must be protected from water or oil splashes. Use a protective cover, if necessary.
 - ★ - Entry of water or used oil into the motor may deteriorate insulation and cause a ground fault.
- (3) The motor must be installed on a sturdy bed, base, or frame.
 - ★ - Adding to the motor weight, dynamic load is applied to the bed during operation, and vibration may occur.
 - ★ - Use a motor of an outside diameter of 250mm×250mm or below operating under vibration acceleration of 2.5G or less (Standard type : 22/18.5kW (30/25HP) or below ; Winding selection type : 11/7.5kW (15/10HP) or below).
For other large capacity models, contact your YASKAWA representative.
- (4) The motor must not be placed where there is excessive dust, iron particles or mist.
 - ★ - The motor core is cooled by air sent from the built-in fan. Accumulation of dust in the air duct reduces cooling capacity and the motor thermal error protection may be activated even under loads within the rating.

3.5.2 Installation Orientation

- (1) Flange-mounted type motors can be installed when the motor output shaft connected to the driven machine is perpendicular to vertically downward position.
 - ★ - When the output shaft is directed upward, excess force is applied to the motor bearing and the life may be shortened.
- (2) Foot-mounted motors must be mounted on the floor with the foot under the motor body.
 - ★ - If the motor is suspended upside down, excess force is applied to the foot and the life may be shortened.
- (3) To place the output shaft in a horizontal position, the terminal box must be on the upper side.
 - ★ - If the terminal box is on the side or bottom, dust easily enters from the air vent under the bracket on the driven machine side, leading to a possible malfunction.

3.5.3 Connection with Driven Machine

- (1) For V-belt drive lay the motor and the driven machine spindle parallel to each other, and perpendicular to the line passing through the centers of both the pulleys. Radial load applied to the motor output shaft extension must not exceed the limit listed in Table 3.2.
 - ★ - If the right angle of the belt is not precise, vibration may occur or the belt may slip. If an excessive radial load is applied to the motor output shaft, excessive force will be applied to the motor bearing and the life may be shortened.
- (2) For gear drive, lay the motor and machine shaft parallel to each other, and engage the shaft at the centers of the tooth surfaces. Tables 3.3 and 3.4 show motor output shaft precision and fixing circumference.
 - ★ - If the tooth surfaces are not engaged properly, gear noise occurs.
- (3) To attach pulleys and gears onto the motor output shaft, they must be well balanced. The motor is in dynamic balance when a half-key having a half-thickness of the size shown in the dimension diagram (of the shaft) is attached.
 - ★ - A slight unbalance may cause vibration during high-speed rotation.

Table 3.2 Allowable Radial Load

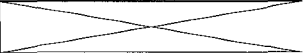
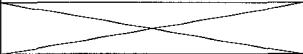
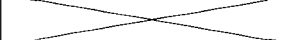
Motor Model UAASK□-□□CZ	Rated Output kW (HP)	Allowable Radial Load N (lb)	
		Standard Model UAASKA	Winding Selection Motors Model UAASKB
04	3.7/2.2 (5/3)	880 (198)	
06	5.5/3.7 (7.5/5)	1760 (397)	2650 (595)
08	7.5/5.5 (10/7.5)		
11 *	11/7.5 (15/10)	2650 (595)	3330 (750)
15	15/11 (20/10)		4410 (992)
19	18.5/15 (25/20)		5200 (1169)
22	22/18.5 (30/25)		
30†	30/22 (40/30)	4900 (1103)	
37†	37/30	6860 (700)	

* The mode of flange-mounted type winding selection motor is UAASKD-11CZ1.

† The model of 30 is UAASKJ-30CZ. The model of 37 is UAASKJ-37CZ.

Table 3.3 Mechanical Specifications of Foot-Mounted Type (mm)

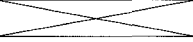
	Accuracy (T.I.R.) *		
	Standard Type	Winding Selection Type	
	Parallel to Shaft	7.5/5.5kW or below	
	11/7.5 to 22/18.5kW	5.5/3.7 to 11/7.5kW	0.033
	30/22kW, 37/30kW	15/11 to 22/18.5kW	0.042
Shaft Run Out	7.5/5.5kW or below		0.02
	11/7.5 to 22/18.5kW	5.5/3.7 to 11/7.5kW	0.022
	30/22kW, 37/30kW	15/11 to 22/18.5kW	0.028

* T.I.R. : Total Indicator Reading

Table 3.4 Mechanical Specifications of Flange-Mounted Type (mm)

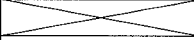
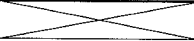
	Accuracy (T.I.R.) *		
	Standard Type	Winding Selection Type	
	Flange Surface Perpendicular to Shaft	22/18.5kW or below	
	30/22kW	15/11kW	0.06
	37/30kW	18.5/15 to 22/18.5kW	0.072
Flange Diameter Concentric to Shaft	7.5/5.5kW or below		0.04
	11/7.5 to 22/18.5kW	5.5/3.7 to 11/7.5kW	0.046
	30/22kW	15/11kW	0.048
	37/30kW	18.5/15 to 22/18.5kW	0.070
Shaft Run Out	7.5/5.5kW or below		0.02
	11/7.5 to 22/18.5kW	5.5/3.7 to 11/7.5kW	0.022
	30/22kW, 37/30kW	15/11 to 22/18.5kW	0.028

* T.I.R. : Total Indicator Reading

3.6 ENCODER

Motor speed is detected by a magnetic encoder containing a magnetic disk. When home position signal is used, detection signals are, two phases 1024-P/R signals, namely A and B, and a 1-P/R home position pulse. When the motor is used for driving the spindle of a milling machine, resolution of the signals is the same as that of the spindle encoder. When the motor shaft and the spindle are connected at a ratio of 1 : 1, the motor encoder can be used as the spindle encoder. Fig. 3.4 is the encoder configuration diagram. Fig. 3.5 shows relation of the output phases during forward rotation.

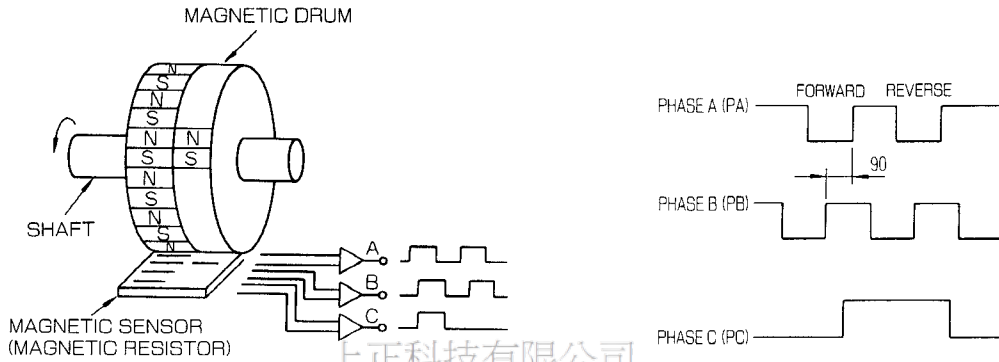

Fig. 3.4 Encoder Configuration

Fig. 3.5 Output Phases

Table 3. 5 Encoder Signal Connectors Terminal Assignment (when home position signal is used)

ML connector (MLR-12)		No.	Name	Wire color	No.	Name	Wire color
	1	+5V	Red	7	PC	Gray	
	2	0V	Black	8	*PC	White (gray)	
	3	PA	Green	9	FG	—	
	4	*PA	White (green)	10	SS	Shield	
	5	PB	Purple	11	TS	Thermistor lead for the motor	
	6	*PB	White (purple)	12			

Note : • Pins 11 and 12 are thermistor signal wires from the motor.
 • An asterisk before PA,PB,and PC indicates reverse signal.
 • The housing and pin contact of the cable connector belong to the motor.

Cable connector for the encoder (manufactured by Japan Solderless Terminal Sales)

Housing : MLP-12
 Pin contact : LLF-01T-1.3 (Pins 1 to 12, excluding pin 10)
 LLF-41T-1.3 (Pin 10)

Motor connector for the encoder (manufactured by Japan Solderless Terminal Sales)

Housing : MLR-12
 Pin contact : LLM-01T-1.3 (Pins 1 to 12, excluding pin 10)
 LLM-41T-1.3 (Pin 10)

4. INVERTER SPECIFICATIONS

4.1 OUTLINE

VS-626VM3 Drives are high-performance vector-controlled inverters for driving high-speed AC motors. Each drive consists of a PWM control inverter, a power-regenerative converter, and a controller of the main circuits of the inverter and the converter. The drives have the following advantages:

(1) High Reliability

High reliability is guaranteed by large-scale gate arrays, simple circuit configuration, minimum components and wide allowance by fully-digitized control.

(2) High-precision Speed Control

A high-speed power transistor, or an insulated gate bipolar transistor (IGBT) is adopted for high-frequency pulse width modulation (PWM) control to improve motor current control precision. As a result, current distortion that may generate torque ripples is suppressed and rotation deviations are reduced.

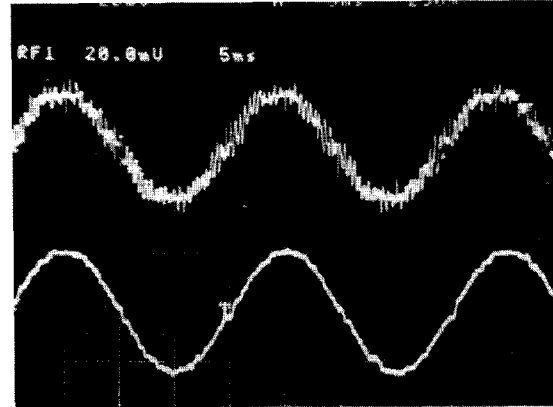

PWM FREQUENCY [Upper : 3.8kHz : Lower : 10kHz]

Fig. 4.1 Current Waveform

(3) High Torque Control Performance

VS-626VM3 Drives employ torque current-control vector control. Motor current is controlled based on motor speed and motor circuit constants. Required torque is generated over a wide range of speeds. The digital signal processor (DSP) used in the control circuit enables high-speed digital control. Vector control can control exciting current and makes it easy to output constant power, thereby saving the inverter capacity.

(4) Enhanced Servo Performance

High-speed operation and high-frequency PWM control by the DSP improves servo performance, enhancing orientation control and solid tapping function. Also, orientation control time has been reduced by the use of motor encoder detection signals for positioning.

(5) Enhanced Orientation Functions

The home position orientation control function of the motor encoder, which is used when the motor and drive shaft are combined at a ratio of 1:1, is supported as standard. Orientation control by the magnetic sensor also uses motor encoder detection signals for orientation at an arbitrary position.

(6) Low Noise

The use of high frequencies for PWM control reduces audible motor magnetic noise. Ripple current is also reduced, cutting motor high-frequency loss, which is one of the causes of thermal deformation of the machine.

(7) Continuous Regenerative Operation

The IGBT is also used for the converter to allow frequent acceleration and deceleration, suppress temperature rise, and save energy. Power regenerative efficiency has been improved, enabling continuous regenerative operation at high speed.

(8) Ease of Operation and Maintenance

The fully digitized control circuit makes adjustment and maintenance easy. The digital operator supports constant setup and monitoring functions, which also contributes to ease of operation. To facilitate maintenance and mounting onto the control panel, a single panel inverter can be mounted either in the control panel or on the outside with an external heat sink.

上正科技有限公司
購買、維修 此手冊零組件
電話： 037-466333
Email: service@repairtw.com
Line id: @zzzz
www.repairtw.com

4.2 CONFIGURATION AND FUNCTIONS

4.2.1 Equipment Configuration and General Specifications

Fig. 4.2 shows a system configuration of VS-626VM3, Table 4.1 shows general specifications of inverter.

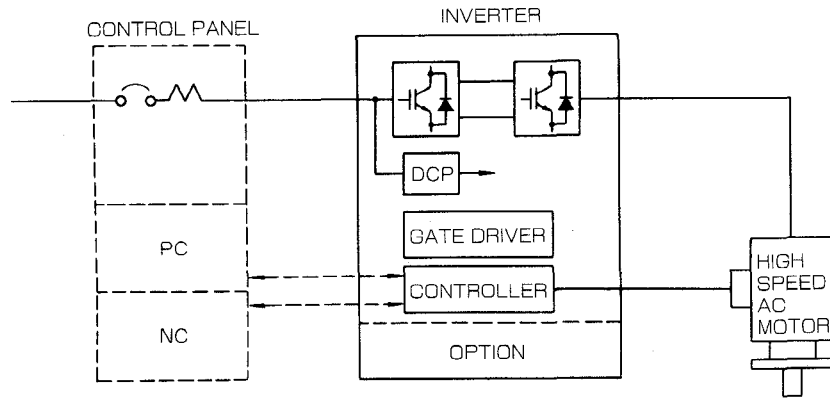

Fig. 4.2 System Configuration

Table 4.1 General Specifications of Inverter

Main Circuit		Sine wave PWM IGBT inverter control	
Control Method	Speed	Controlled by encoder	
	Torque	Vector control with flux control	
Braking Method		Regenerative brake with power regenerative function	
Speed Adjustable Range		@ZZZZ200 (on condition that to 40 r/min)	
Speed Reference		Analog	Digital
		±10 VDC (100%)	12 bit * (100%)
	Resolution	±0.02%	±0.03%
	Accuracy†	±0.1%	±0.01%
Accel/decel time setup‡		0.1 to 180.0 sec	
Input Signal		Emergency stop, preparation for operation, forward run, reverse run, torque limit, soft start cancel, failure reset, speed reference select, gear ratio select, winding selection	
Output Signal		Zero speed, speed agreed, speed detection, torque detection, torque limit completion, failure, winding selection completion	
Finish in Munsell Notation		5Y7/1	
Ambient Temperature#		0 to +55°C (32 to 131°F) (non-freeze)	
Storage Temperature		-20 to +60°C (-4 to 140°F)	
Humidity		5 to 95% RH (non-condensing)	
Altitude		1000m or below	
Standards		JIS, JEC, JEM,	

* :For digital input, 12-bit binaries, 2-digit binary coded decimals (BCDs), 3-digit BCDs, and internal speed setting can be used.

† :Precision of speed reference is expressed by percentages of the rated reference input.

‡ :Heavy motor load may require more time than the set value for acceleration and deceleration.

:Temperature while in transit.

4.2.2 Operation Status Display Functions

Status of control signals of the units can be displayed to monitor operations. (See Table 4.2.) To monitor the status of operation, use the keys of the digital operator (JVOP-100) on the inverter.

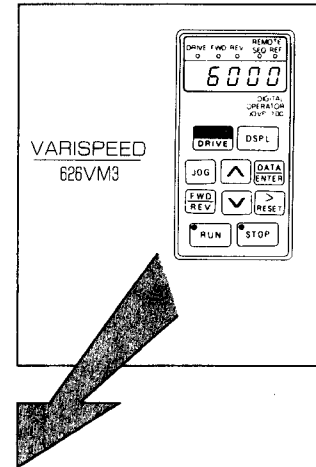

Table 4.2 Status Monitoring Functions

Signal No.	Content	Unit	Display at Power ON	Remarks
V1-01	Motor speed	r/min	0	
V1-02	Speed reference	%	0.00	100% = Rated speed
V1-03	Output shaft speed	r/min	0	
V1-04	Torque reference	%	0.0	100% = 30-minute rating
V1-05	—	—	0.0	
V1-06	Inverter input current	A	0.0	Effective value, accuracy : ± 3 %
V1-07	Inverter output frequency	Hz	0.0	
V1-08	Inside condition	—	—	
V1-09	Input signal condition	—	—	
V1-10	Output signal condition	—	—	
V1-11	Inverter capacity	kW	Depends on unit	
V1-12	Panel inside temperature	°C	Ambient temperature	At cold start
V7-01	Motor temperature	°C	Ambient temperature	At cold start

Note: The digital operator display unit employs 7-segment LEDs. Status of operation is indicated by “V” plus a number, meaning a variable number. Actual display, however, looks like “u” plus a number. (Example: V1-01 - u100) For the detail of display, refer to Par. 13.1 “Functions of the Digital Operator”

4.2.3 Protective Functions

If a failure occurs during operation, a protective function is activated depending on the type of failure, as listed in Table 4.3, and the machine is stopped. If this occurs, the digital operator displays the code of the activated protective function. If two or more failures occur simultaneously, they are recorded in the order of occurrence unless power is shut down. The record can be useful for troubleshooting.

Table 4.3 Protective Functions

Object of Protection	Name	Content	Display	
System	Winding selection error	Winding selection has not been completed within the set time.	F000	
	Excess speed deviation	Actual speed reached 50% or lower of the speed reference. (This protective function is not activated during accel/decel.)	F800	
	Break in wire of speed detection signal	Break in wire or erroneous connection of the motor encoder signal line	FC00	
	Power supply error		Synchronous cycle power signal is lost (when power is turned on).	F600
			Low voltage (85% or below); instantaneous loss of 0.02 second or longer; power loss, or open phase	F602
			Low voltage (150 VAC or lower) of the control circuit power supply; power loss	F604
	Power frequency error		Distinction of the cycle (50 Hz or 60 Hz) is impossible (when power is turned on) .	F601
			Excessive power frequency deviation ($\pm 5\%$ or greater)	F603
	Excessive temperature rise at inverter housing control panel inside		Temperature in the control panel is $+55^{\circ}\text{C}$ or higher. (Minor failure)	F906
			Temperature in the control panel is $+60^{\circ}\text{C}$ or higher.	F907
Inverter	Control function error	ICs in the controller are defective.	CPF00	
	Emergency stop operation failure	The machine did not stopped within 10 seconds after emergency stop was commanded.	F001	
	Output overcurrent	Inverter output current was over the set value.	F100	
	Input overcurrent	Inverter input current was over the set value.	F300	
	Built-in MC failure	The magnetic contactor (MC) of the inverter input unit is disabled.	F200	
	MCCB trip	The molded-case circuit-breaker (MCCB) of the inverter input unit tripped.	F201	
	Inverter overload		Inverter output current of 120% of the 30-minute rating for one minute or longer.	F700
			Inverter input current of 120% of the 30-minute rating for one minute or longer.	F701
	Inverter overvoltage	Inverter DC bus voltage exceeded the overvoltage set limit.	F400	
	Heat sink temperature error		Heat sink temperature exceeded the set value. (Minor failure)	F903
			Heat sink temperature exceeded the set value for one minute or longer.	F904
			The heat sink temperature detection thermistor disconnected.	F905
	Insufficient initial charge	The main capacitor was not fully charged within the set time.	FA00	
Motor	Overspeed	Motor speed reached 120% or greater than the set rated speed.	F500	
	Motor temperature error	Motor temperature exceeded the allowable upper limit. (Minor failure)	F900	
		Motor temperature exceeded the allowable upper limit for four minutes or longer.	F901	
		The motor temperature detection thermistor disconnected.	F902	

- * For protect against hardware and software failures in the inverter, see Par. 13.5, "Protect Function and Display."
- † Set time and set values depend on the inverter capacity. Optimum values are pre-set at the factory.
- ‡ The rated speed is the speed applied to speed reference 10V, which is set to "C1-26". From 100 r/min. to the motor maximum speed can be set.
- # Allowable upper limit of the temperature is specified in JIS C 4004. For motor insulation type F, the temperature is 155°C . Overheat is detected in one minute or more for PROM version NSN620148 and beyond.

4.3 CONTROL BLOCK DIAGRAM

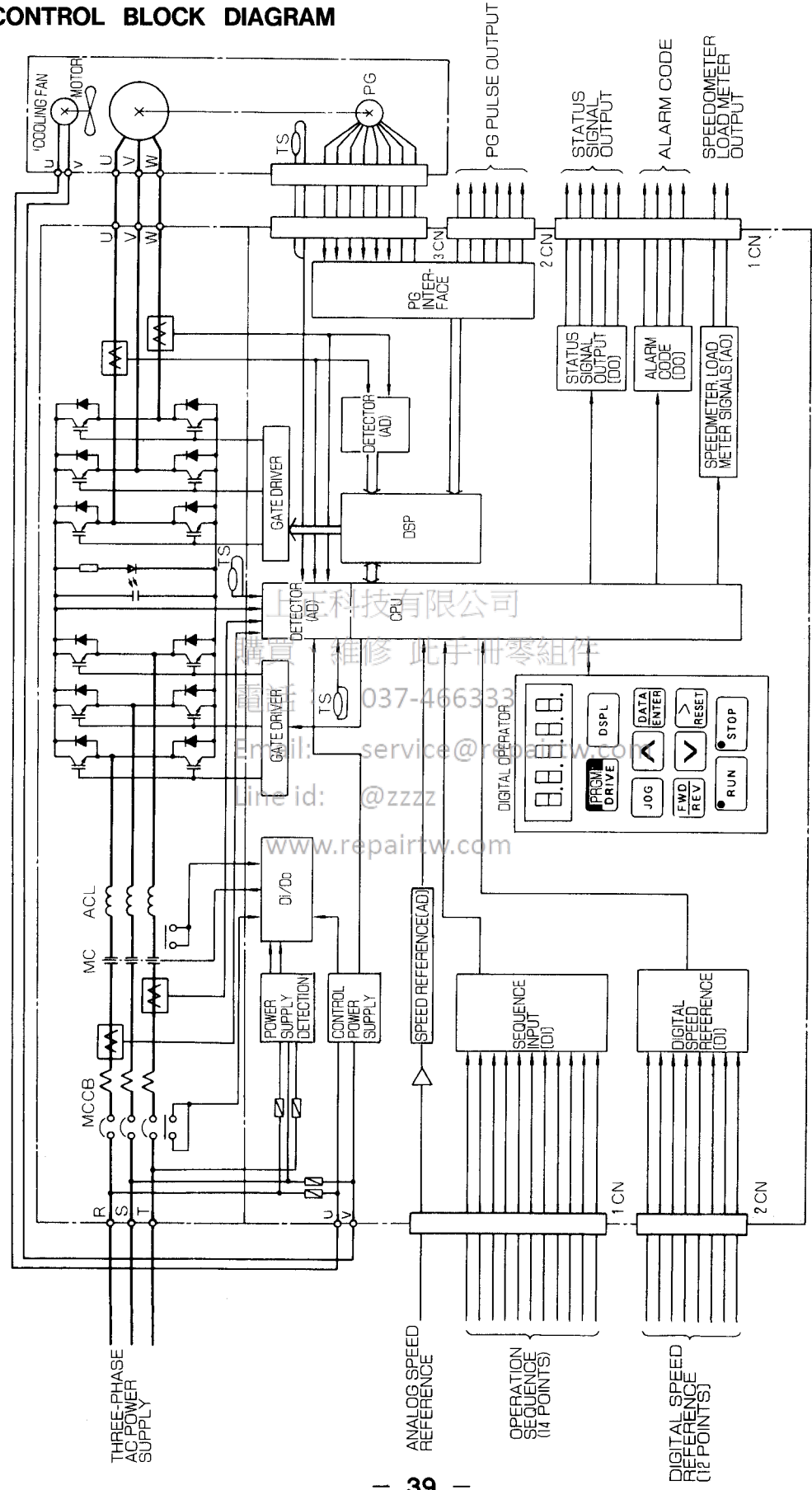
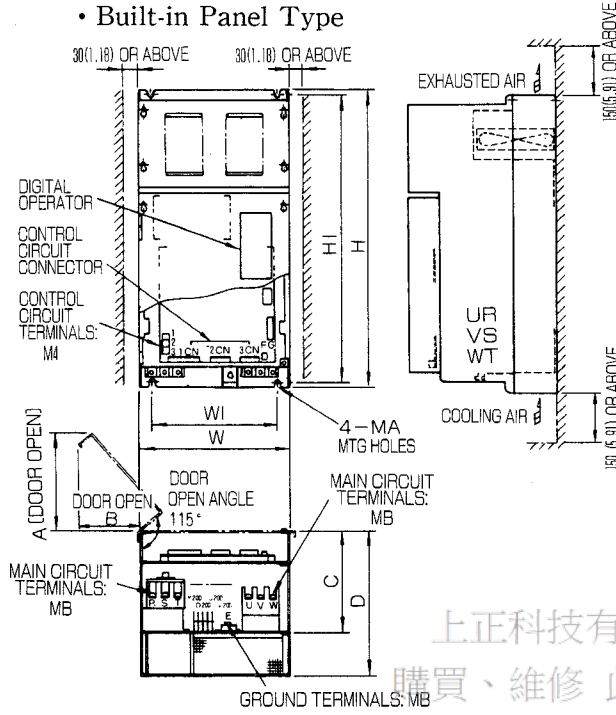

Fig. 4.3 Block Diagram of VS-626VM3

4.4 DIMENSIONS in mm (in inches)

(1) 200V Series Inverter • Built-in Panel Type



• Heat Sink External Cooling Type

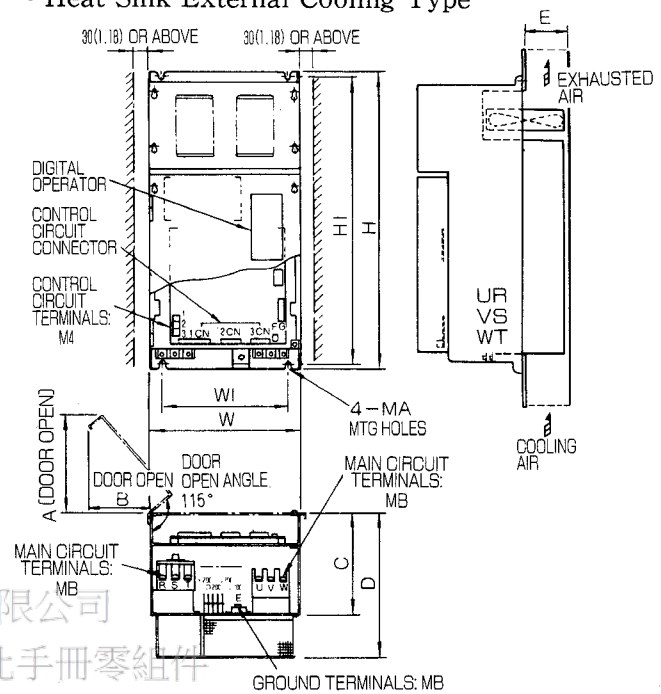

Model	CIMR-VM	W	H	D	WI	HI	A	B	C	E	MA	MB	Approx Mass kg (lb)
23P7	2	250 (9.84)	470 (18.50)	284 (11.18)	200 (7.87)	455 (17.91)	255 (10.04)	210 (8.27)	220 (8.66)	75to75 (2.76to 2.95)	M6	M5	22 (48.5)
	0			286 (11.26)									25 (55.1)
25P5	2	250 (9.84)	470 (18.50)	284 (11.18)	200 (7.87)	455 (17.91)	255 (10.04)	210 (8.27)	220 (8.66)	70to75 (2.76to 2.95)	M6	M5	23 (50.7)
	0			286 (11.26)									26 (57.3)
27P5	2	250 (9.84)	470 (18.50)	303 (11.93)	200 (7.87)	455 (17.91)	255 (10.04)	210 (8.27)	220 (8.66)	85to90 (3.35to 3.54)	M6	M5	24 (52.7)
	0			306 (12.05)									27 (59.5)
2011	2	300 (11.81)	600 (23.62)	291 (11.46)	250 (9.84)	580 (22.83)	303 (11.93)	278 (10.94)	207 (8.15)	90to95 (3.54to 3.74)	M8	M8	32 (70.5)
	0			294 (11.57)									36 (79.4)
2015	2	300 (11.81)	600 (23.62)	291 (11.46)	250 (9.84)	580 (22.83)	303 (11.93)	278 (10.94)	207 (8.15)	90to95 (3.54to 3.74)	M8	M8	35 (77.2)
	0			294 (11.57)									39 (86.0)
2018	2	360 (14.17)	600 (23.62)	344 (13.54)	300 (11.81)	580 (22.83)	362 (14.25)	355 (13.98)	240 (9.45)	110to115 (4.33to 4.53)	M8	M8	44 (97.0)
	0			348 (13.70)									48 (105.8)
2022	2	420 (16.54)	600 (23.62)	344 (13.54)	370 (14.57)	580 (22.83)	292 (11.50)	160 (6.30)	240 (9.45)	110to115 (4.33to 4.53)	M8	M8	54 (119.0)
	0			348 (13.70)									59 (130.1)
2030	2	470 (18.50)	700 (27.56)	344 (13.54)	350 (13.78)	680 (26.77)	307 (12.09)	122 (4.80)	240 (9.45)	110to115 (4.33to 4.53)	M8	M8	65 (143.3)
	0			348 (13.78)									71 (156.5)
2037	2	470 (18.50)	700 (27.56)	362 (14.25)	350 (13.78)	680 (26.77)	307 (12.09)	122 (4.80)	240 (9.45)	130to135 (5.12to 5.31)	M8	M8	66 (145.5)
	0			368 (14.49)									72 (158.5)

Note: Values (2,0) in model column show the enclosures. (0: built-in panel type, 2: heat sink external cooling type)

Fig. 4.4 Dimensions of 200V Series

(2) 400V Series Inverter

• Built-in Panel Type

• Heat Sink External Cooling Type

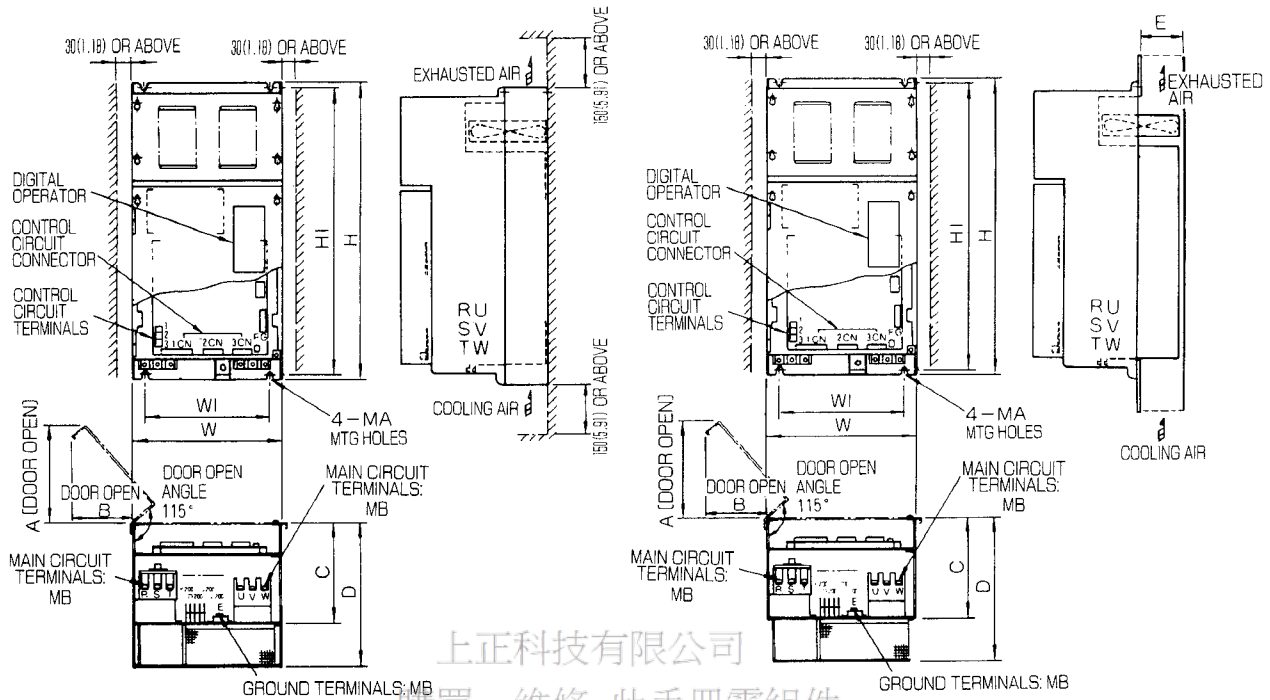

上正科技有限公司
購買、維修 此手冊零組件

Model CIMR-VM	W	H	D	WI	HI	A	B	C	E	MA	MB	Approx Mass kg (lb)
47P5	2	2.50 (9.84)	470 (18.50)	303 (11.93)	200 (7.87)	455 (17.91)	255 (10.04)	210 (8.27)	220 (8.66)	M6	M5	24 (52.9)
	0			306 (12.05)					85to90 (3.35to 3.54)			27 (59.5)
4011	2	300 (11.81)	600 (23.62)	291 (11.46)	250 (9.84)	580 (22.83)	303 (11.93)	278 (10.94)	207 (8.15)	M8	M8	32 (70.5)
	0			294 (11.57)					90to95 (3.54to 3.74)			36 (79.4)
4015	2	300 (11.81)	600 (23.62)	291 (11.46)	250 (9.84)	580 (22.83)	303 (11.93)	278 (10.94)	207 (8.15)	M8	M8	35 (77.2)
	0			294 (11.57)					90to95 (3.54to 3.74)			39 (86.0)
4018	2	360 (14.17)	600 (23.62)	344 (13.54)	300 (11.81)	580 (22.83)	362 (14.25)	355 (13.98)	240 (9.45)	M8	M8	44 (97.0)
	0			348 (13.70)					110to115 (4.33to 4.53)			48 (105.8)
4022	2	420 (16.54)	600 (23.62)	344 (13.54)	370 (14.57)	580 (22.83)	292 (11.50)	160 (6.30)	240 (9.45)	M8	M8	50 (110.2)
	0			348 (13.70)					110to115 (4.33to 4.53)			55 (121.6)
4030	2	470 (18.50)	700 (27.56)	348 (13.70)	350 (13.78)	680 (26.77)	307 (12.09)	122 (4.80)	240 (9.45)	M8	M8	65 (143.3)
	0			350 (13.78)					110to115 (4.33to 4.53)			71 (156.5)
4037	2	470 (18.50)	700 (27.56)	344 (13.54)	350 (13.78)	680 (26.77)	307 (12.09)	122 (4.80)	240 (9.45)	M8	M8	66 (145.7)
	0			348 (13.70)					110to115 (4.33to 4.53)			72 (158.9)

Note: Values (2,0) in model column show the enclosures. (0: built-in panel type, 2: heat sink external cooling type)

Fig. 4.5 Dimensions of 400V Series

(3) Panel Hole Dimensions

Panel hole dimensions depend on the inverter capacity, but not on the applicable power voltage.

Place packing on the hatched area to avoid dust entry.

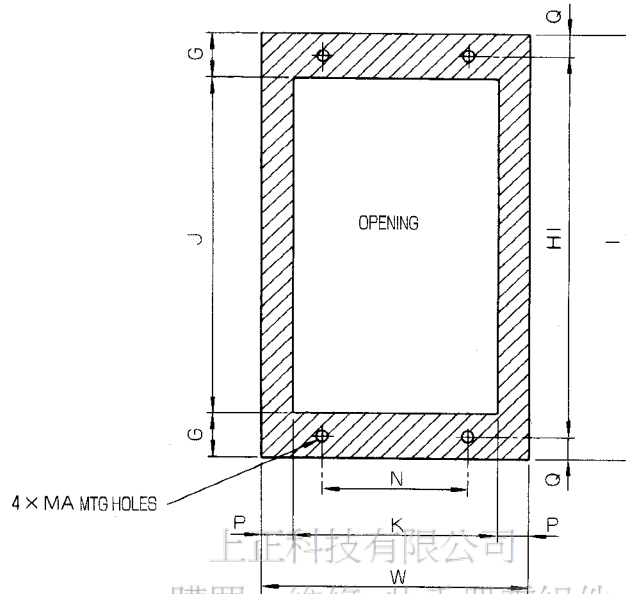

上海科技有限公司
 購買、維修 此手冊零組件
 電話： 037-466333

Model CIMR-VM	W	HI	G	I	J	K	N	P	Q	MA
23P7	250 (9.84)	455 (17.91)	15 (0.59)	470 (18.50)	440 (17.32)	234 (9.21)	200 (7.87)	8 (0.31)	7.5 (0.30)	M6
25P5	250 (9.84)	455 (17.91)	15 (0.59)	470 (18.50)	440 (17.32)	234 (9.21)	200 (7.87)	8 (0.31)	7.5 (0.30)	M6
27P5	250 (9.84)	455 (17.91)	15 (0.59)	470 (18.50)	440 (17.32)	234 (9.21)	200 (7.87)	8 (0.31)	7.5 (0.30)	M6
2011	300 (11.81)	580 (22.83)	20 (0.79)	600 (23.62)	560 (22.05)	284 (11.18)	250 (9.84)	8 (0.31)	10 (0.39)	M8
2015	300 (11.81)	580 (22.83)	20 (0.79)	600 (23.62)	560 (22.05)	284 (11.18)	250 (9.84)	8 (0.31)	10 (0.39)	M8
2018	360 (14.17)	580 (22.83)	20 (0.79)	600 (23.62)	560 (22.05)	344 (13.54)	300 (11.81)	8 (0.31)	10 (0.39)	M8
2022	420 (16.54)	580 (22.83)	20 (0.79)	600 (23.62)	560 (22.05)	404 (15.91)	370 (14.57)	8 (0.31)	10 (0.39)	M8
2030	470 (18.50)	680 (26.77)	20 (0.79)	700 (27.56)	660 (25.98)	454 (17.87)	350 (13.78)	8 (0.31)	10 (0.39)	M8
2037	470 (18.50)	680 (26.77)	20 (0.79)	700 (27.56)	660 (25.98)	454 (17.87)	350 (13.78)	8 (0.31)	10 (0.39)	M8

Fig. 4.6 Panel Hole Dimensions

4.5 INSTALLATION CONDITIONS

Take the following requirements into account when designing a control panel to contain the inverter.

4.5.1 Installation Location

- (1) Avoid water and oil splashes.
 - ★ - Entry of water or used oil into the inverter may deteriorate insulation and cause a ground fault.
- (2) Avoid direct sunlight.
 - ★ - Radiant heat of the sun may raise the temperature in the inverter over the operating temperature range and significantly reduce life of electronic components.
- (3) Avoid harmful gases and liquids. Avoid locations where there is excessive dust or iron particles.
 - ★ - Corrosion by harmful gases or adhesion of dust may deteriorate insulation resistance and cause a ground fault.
- (4) Design cooling air ducts and heat exchangers adequate to dissipate heat output from the inverter. Table 4.4 lists heat dissipation from inverters of different capacities.
 - ★ - If heat dissipation is insufficient, a heat sink overheat prevention function is performed even when the output is within the rating.
- (5) The inverter houses a heat sink cooling fan on the back. Leave 150 mm or greater clearance on the upper (exhaust) and lower (entry) sides of the fan to prevent cooling performance deterioration. Table 4.4 lists required cooling air capacity for inverters of different capacities.
 - ★ - If air flow is obstructed and insufficient cooling air is supplied, a heat sink overheat prevention function is performed even when the output is within the rating.
- (6) Although the control panel built-in type inverter is operable at 0°C to +55°C, input air to the heat sink must be 45°C or cooler.
 - ★ - If hotter air is input, heat dissipation from the heat sink is hindered and a heat sink overheat prevention function is performed even when the output is within the rating.
- (7) Input and output terminals and control signal connectors are on the bottom of the inverter. Provide clearance under the inverter for wiring.
 - ★ - If wiring space is insufficient, control boards and terminals may be squeezed during wiring, causing unpredictable troubles.
- (8) As shown in Fig. 4.7, cooling efficiency can be improved by making the control panel itself into an air duct and projecting the inverter unit in the duct to expose the heat sink directly to cooling air. If a heat exchanger is required, the capacity can be reduced by this method.
- (9) Place packing on the unit mounting portion to prevent entry of dust.
 - ★ - If no packing is used, water or iron particles may enter from the joint and deteriorate insulation to cause a ground fault.
- (10) When the inverter unit is mounted on the same plane as the servo unit, use an adapter for the inverter unit to compensate for the difference of the heat sinks. (See Fig. 4.7.)
- (11) When circulating air in the cabinet for cooling, do not blow the air directly against the inverter unit.
 - ★ - Although surface of the PC boards is finished with varnish, adhesion of water or dust may cause unpredictable troubles.
- (12) Take periodical inspection and maintenance of the inverter into account when designing

the control panel. Be sure to leave sufficient space to open and close the PC board mounting frame. Also provide clearance of 30 mm or greater from each end panel of the inverter. (See Fig. 4.8.)

- ★ - If the above clearances are not provided, proper inspection and maintenance will be impossible.

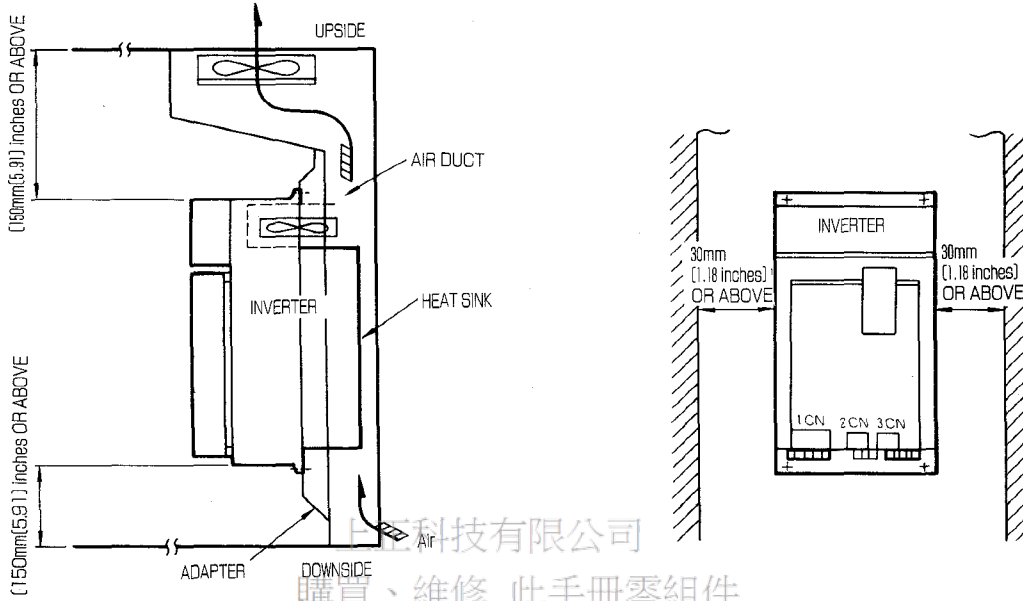

Fig. 4.7 Side View of Installation 037-466333 Fig. 4.8 Front View of Installation

4.5.2 Installation Orientation

For cooling efficiency and ease of maintenance of the inverter, install it vertically with the input and output terminals on the lower side.

- ★ - If the inverter is installed in a horizontal position, heat accumulates in the unit and may exceed the operating temperature range, and the life of electronic components may be significantly shortened.

Table 4.4 Inverter Calorific Value and Cooling Air Capacity

Inverter Model		23P7		25P7		27P5		2011		2015		2018		2022		2030		2037		
CIMR-VM		Output		Output		Output		Output		Output		Output		Output		Output		Output		
		Continuous	30-minute	Continuous	30-minute	Continuous	30-minute	Continuous	30-minute	Continuous	30-minute	Continuous	30-minute	Continuous	30-minute	Continuous	30-minute	Continuous	30-minute	
Calorific Value (W)	Built-in Type	232	326	345	475	462	608	546	786	789	1056	1027	1279	1365	1623	1416	1952	1600	2078	
	Totally-enclosed Type	Outside of heat sink	101	181	203	306	301	417	364	559	571	785	747	949	1037	1241	1072	1500	1206	1569
		Inside of heat sink	131	145	142	169	161	191	182	227	218	272	280	330	328	383	344	452	394	509
Front Air Capacity (m ³ /min)		1.8				3.5				5.1				6.4						

4.6 STANDARD WIRING DIAGRAM

(1) 200V Series

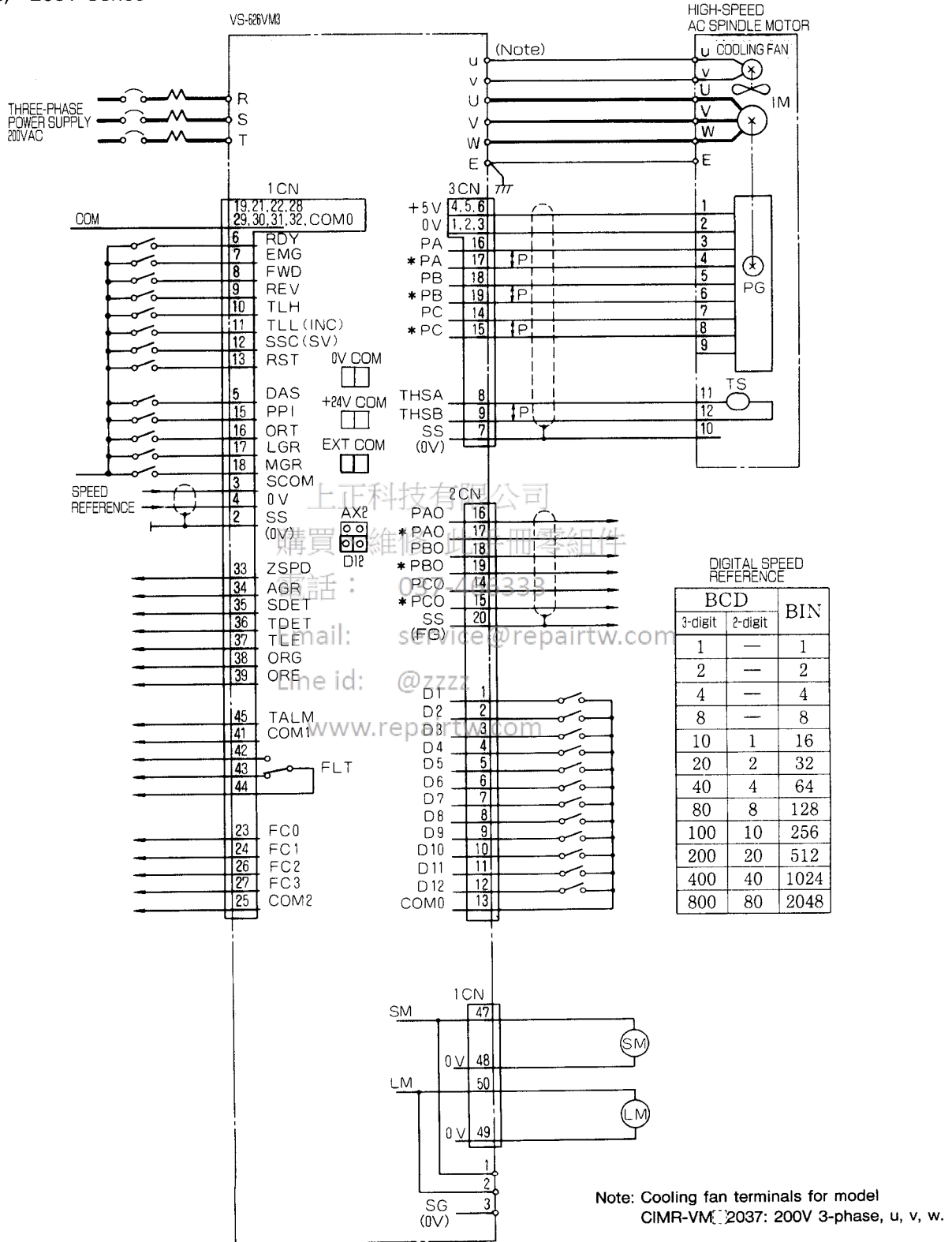
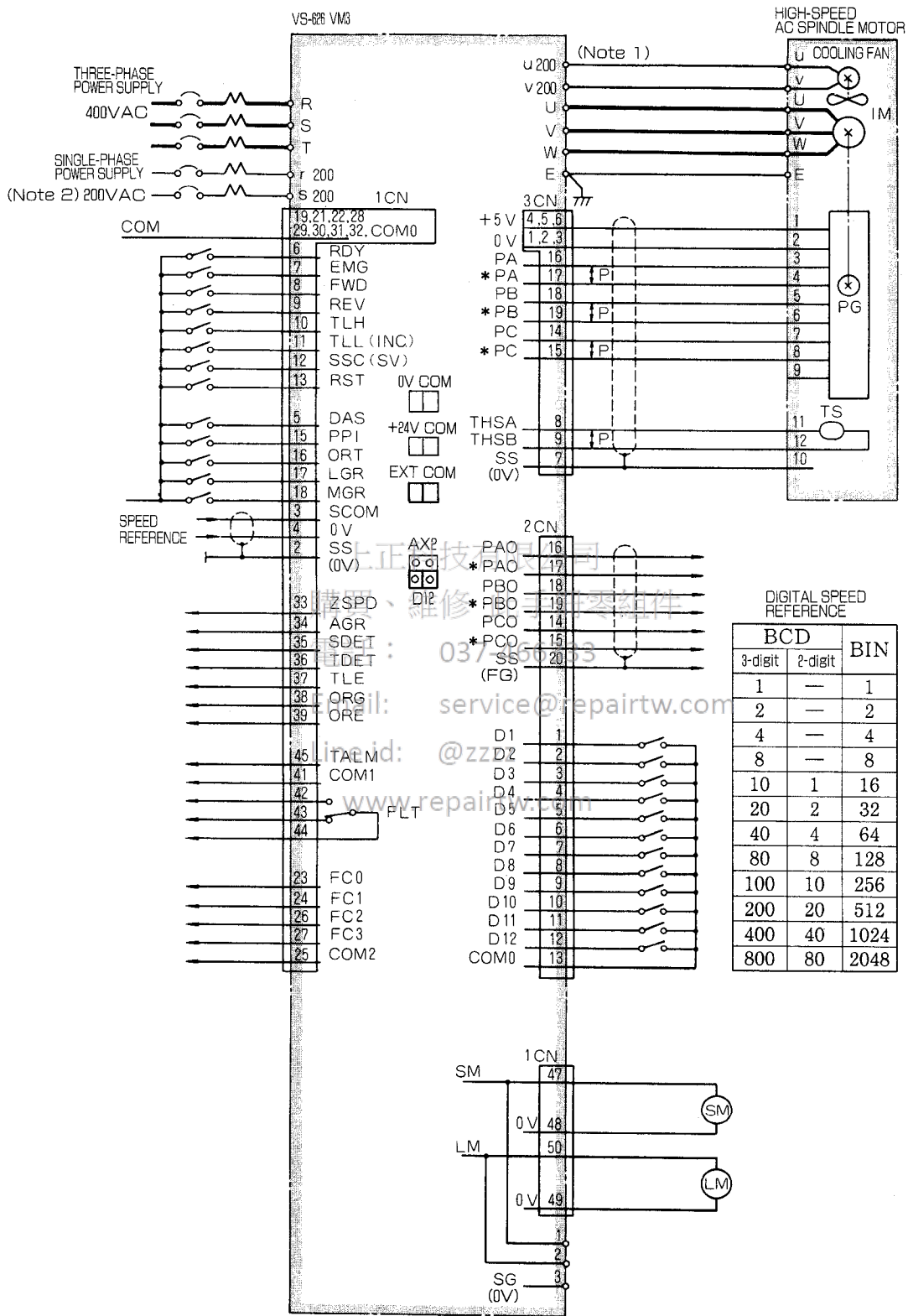

Fig. 4.9 Standard Wiring Diagram (200V Series)

(2) 400V Series



DIGITAL SPEED REFERENCE

BCD		BIN
3-digit	2-digit	
1	—	1
2	—	2
4	—	4
8	—	8
10	1	16
20	2	32
40	4	64
80	8	128
100	10	256
200	20	512
400	40	1024
800	80	2048

Notes:

1. Cooling fan terminals for model CIMR-VM4037 : 200V 3-phase, u200, v200, w200.
2. Control power supply for model CIMR-VM4037 : 200V 3-phase, r200, s200, t200.

Fig. 4.10 Standard Wiring Diagram (400V Series)

(3) 200V Winding Selection Type Series

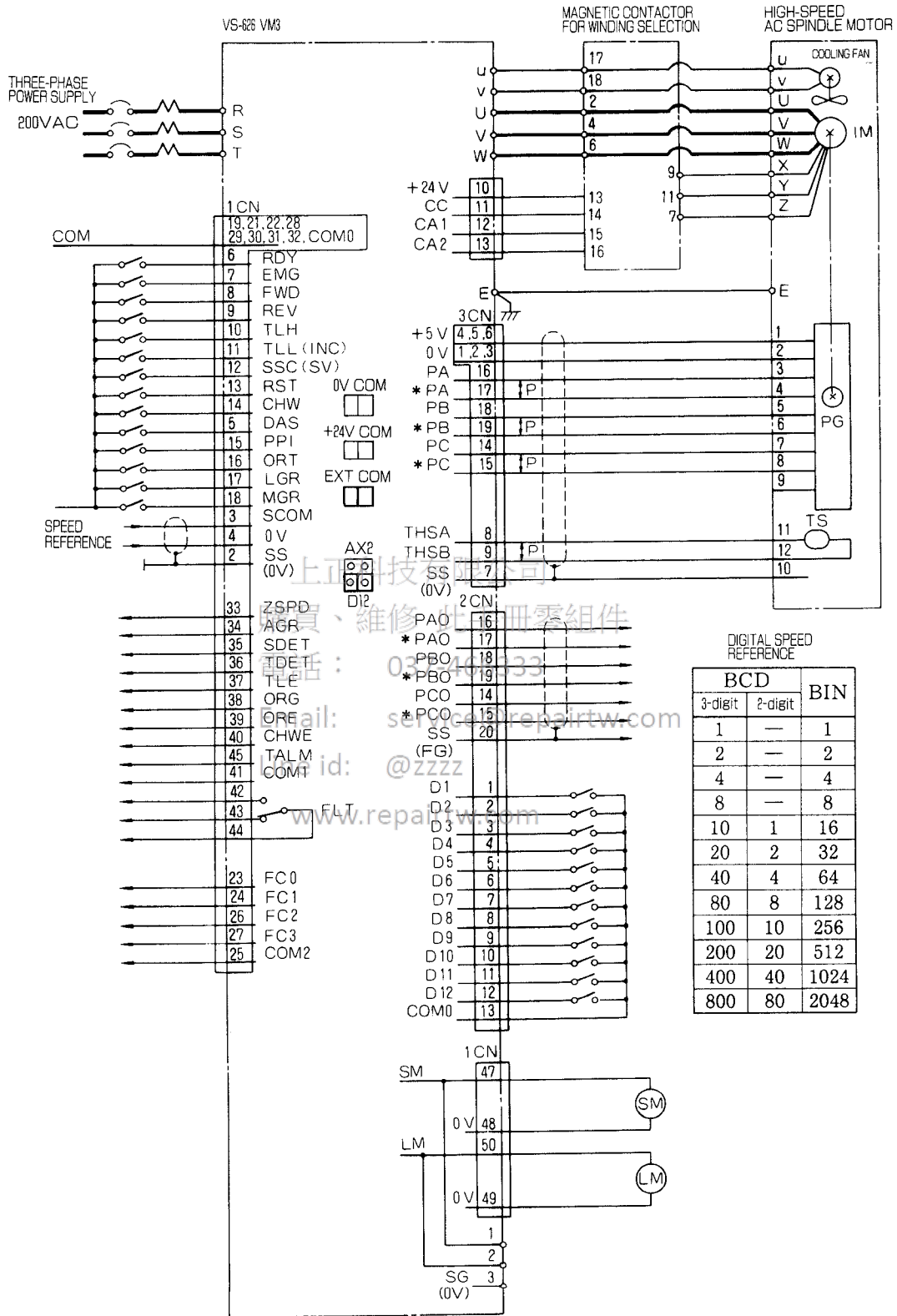

Fig. 4.11 Standard Wiring Diagram (Winding Selection Type)

4.7 WIRING SPECIFICATIONS

Take the following into account when selecting the inverter power cables, motor cooling fan power cables, and control signal lines.

4.7.1 Power Cables and Terminals

Table 4.5 lists the rated current, types and size of cables, and terminal size of the inverters. Layout of the motor terminal box is shown in Fig. 3.1 (Motor construction). Layout of input and output terminals of the inverters is shown in Par. 4.4 (DIMENSIONS).

Table 4.5 Power Cable Specifications

Inverter Model CIMR-VM	30-minute Rated Current (A)	Cable Nominal Cross Section (mm ²)*			Terminal Name and Screw Size			
		600V Vinyl Cable (IV, VV)	600V Flame-resistant Crosslinked Polyethylene Cable	600V Rubber-insu- -lated Cabtyre Cable (CT)	Inverter Terminals		Motor Terminals	
					Input	Output		
200V	23P7	22	3.5	2.0	3.5	M5	M5	M4
	25P5	33	5.5	3.5	5.5	M5	M5	M5
	27P5	45	8.0	5.5	8.0	M5	M5	M5
	2011	66	14.0	14.0	14.0	M8	M8	M8
	2015	90	30.0	22.0	22.0	M8	M8	M8
	2018	111	38.0	22.0	28.0	M8	M8	M8
	2022	132	50.0	30.0	50.0	M8	M8	M8
	2030	180	—	50.0	—	M8	M8	M8
400V	47P5	22	3.5	2.0	3.5	M5	M5	M5
	4011	33	5.5	3.5	5.5	M8	M8	M8
	4015	45	8.0	5.5	8.0	M8	M8	M8
	4018	55	14.0	8.0	14.0	M8	M8	M8
	4022	66	14.0	14.0	22.0	M8	M8	M8
	4030	90	30.0	22.0	30.0	M8	M8	M8
	4037	111	38.0	22.0	30.0	M8	M8	M8
	4045	135	50.0	30.0	50.0	M8	M8	M8
Terminal Symbol						R, S, T, E	U, V, W, E	U, V, W, E

*Cable size is selected assuming external suspended wiring of single 3-core cables at an ambient temperature of 30°C. Maximum allowable conductor temperature is 60°C for the IV, VV, and CT cables, and 110°C for the 600V flame-resistant crosslinked polyethylene cable.

—  — Notes on selecting cables when the ambient temperatures are high

If the ambient temperature is higher than 30°C, allowable current of cables is decreased. Refer to the rated current in Table 4.5 and select appropriate cable size according to JIS standards or the technical data provided by the cable manufacturer. Related JIS standards are as follows:

IV: JIS C 3307
 VV: JIS C 3342
 CT: JIS C 3302

The flame-resistant crosslinked polyethylene cable shall conform to Japan cable industrial standard JCS No.360.

4.7.2 Control Power Cable and Motor Cooling Fan Power Cable

Inverters of the 200V series require no external control power supply because they have a built-in control power source connected to the main circuit power source. On the contrary, inverters of the 400V series require single-phase 200V power. Motor cooling fan also requires single-phase 200V power. Table 4.6 lists types and size of the cables and terminal size.

Layout of the motor terminal box is shown in Fig 3.1 (Motor construction). Layout of input and output terminals of the inverters is shown in Par. 4.4 (DIMENSIONS).

Table 4.6 Control Power Cable and Motor Cooling Fan Power Supply

Inverter	Cable		Terminal Name and Size		
	Cable Type	Cable Nominal Cross Section (mm ²)	Inverter Terminals		Motor Cooling Fan Terminal
			Control Power Supply Input	Cooling Fan Output	
200V series	600V vinyl-Sheathed cable (IV,VV)	2.0		M4	M4
400V series			M4	M4	M4

上正科技有限公司

4.7.3 Control Signal Lines

Table 4.7 lists types and sizes of control signal connectors and cables. Layout of the motor terminal box is shown in Fig. 3.1 (Motor construction). Layout of input and output terminals of the inverters is shown in Par. 4.4 (DIMENSIONS).

Table 4.7 Specifications of Control Signal Connectors and Cables

Between NC/PC and Inverter		Between Inverter and Motor Encoder		
Cable	Connector	Connector	Cable	Connector
0.3mm ² Concentric 50-core or 600V vinyl Sheathed cable (IV) (0.5mm ²)*	<1CN> MR-50LF† (50 pins)	<3CN> MR-20LF† (20 pins)	Complex KQVV-SW ‡ AWG 22 × 3C AWG 26 × 6P YASKAWA drawing No. DP 8409123	MLP-12# (12 pins)
Complex KQVV-SW AWG 22 × 3C AWG 26 × 6P YASKAWA drawing No. DP 8409123	<2CN> MR-20LM† (20 pins)			

* For the 1CN signal line except for the analog signals such as speed reference, 600V vinyl sheathed cable (IV) can be used. When this cable is used, the signal and power cables must be separated and the cable extension must be as short as possible (20m or less) to reduce noise.

† The diameter of the wire bundle must not be greater than the connector leading port.

MR-50LF: 16mm dia.
MR-20LF, LM; 11mm dia.

‡ The signal and power cables between the inverter and the motor encoder must be separated and the cable extension must be as short as possible (20m or less) to reduce noise.

For details of motor encoder connector, refer to Table 3.5 in Para. 3.6.

Note: Do not run the signal and power cables in the same duct and do not bundle them. Malfunction of the equipment may occur.

4.7.4 Control Signal Connectors Terminal Assignment

Fig. 4.12 shows terminal layout of the control signal connector. Also refer to Fig. 4.9 to 4.11 (Standard connection diagrams) when designing interface with NC or PC. For explanations about control signals, see Par. 4.8, "Control Signals."

50	49	48	47	46	45	44	43	42	41	40	39	38	37	36	35	34	33
LM	0 V	0 V	SM		TALM	FLT COM	FLT NC	FLT NO	COM 1	CHWE	ORE	ORG	TLE	TDET	SDET	AGR	ZSPD
		32	31	30	29	28	27	26	25	24	23	22	21	20	19		
		COM 0	COM 0	COM 0	COM 0	COM 0	FC3	FC2	COM 2	FC1	FC0	COM 0	COM 0	COM 0	COM 0		
18	17	16	15	14	13	12	11	10	9	8	7	6	5	4	3	2	1
MGR	LGR	ORT	PPI	CHW	RST	SSC (SV)	TLL (INC)	TLH	REV	FWD	EMG	RDY	DAS	0 V	SCOM	SS (0V)	+15 V

PCB Side Connector ; MR-50RMAG
Cable Side Connector ; MR-50LF (G)

(a) CONTROLLER 1CN

14	15	16	17	18	19	20	20	19	18	17	16	15	14
PCO	*PCO	PAO	*PAO	PBO	*PBO	SS (FG)	FG	*PB	*PB	*PA	PA	*PC	PC
	8	9	10	11	12	13		13	12	11	10	9	8
	D8	D9	D10	D11	D12	COM 0		CA2	CA1	CC	+24 V	THSB	THSA
1	2	3	4	5	6	7	7	6	5	4	3	2	1
D1	D2	D3	D4	D5	D6	D7	SS (0V)	+5 V	+5 V	+5 V	0 V	0 V	0 V

PCB Side Connector ; MR-20RFAG
Cable Side Connector ; MR-20LM (G)

PCB Side Connector ; MR-20RMAG
Cable Side Connector ; MR-20LF (G)

(b) CONTROLLER 2CN

(c) CONTROLLER 3CN

- Notes: 1. The terminal layout is a view of the board connector viewed from the engaged part.
2. In the figures, □ indicates an input signal to the inverter, whereas □ indicates an output signal from the inverter.
3. Pins 10 to 13 of 3CN are winding selection input-output signals.
4. For the terminal layout of the motor encoder connector, see Table 3.5.
5. Asterisk (*) with the 2CN and 3CN signals indicates reverse rotation signal.

Fig. 4.10 Connector Pin Location

4.7.5 Notes on Wiring Power Cables and Control Signal Lines

Complete VS-626VM3 interconnections, following the instructions given below.

- (1) Control signal leads (ICN to 3CN) must be separated from main circuit leads (R, S, T, U, V, W) and other power lines and power supply lines to prevent erroneous operation caused by noise interference.
 - ★ - If a signal line (especially the motor encoder signal line) runs along a power cable, the dv/dt noise from the power cable may cause a serious malfunction.
- (2) When a twisted shielded lead is used for the control signal line, the terminal must be insulated as shown in Fig. 4.13, except for the motor encoder signal line between the inverter and the motor which must be connected on both ends because the encoder signal line in the motor is a multicore shielded cable. The extension of the control signal line including the encoder signal line must be 20 m or less.
 - ★ - A longer motor encoder signal line between the inverter and the motor may result in a voltage drop in the line, reducing encoder power voltage and causing a serious malfunction.

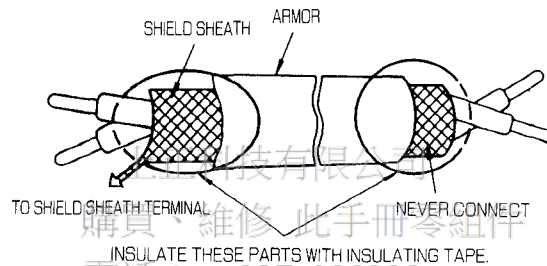
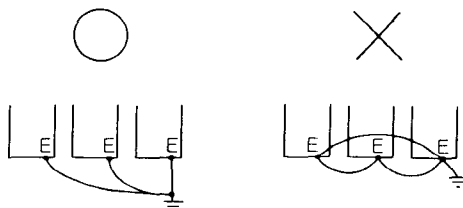

Fig. 4.13 Shielded Lead Termination

- (3) Make a positive grounding using ground terminal E on the casing of VS-626VM3.
 - Ground resistance should be 100Ω or less.
 - Never ground VS-626VM3 in common with welding machines, motors, and other large-current electrical equipment, or ground pole. Run the ground lead in a separate conduit from leads for large-current electrical equipment.
 - Use ground lead listed in technical standards of electric installation and make the length as short as possible.
 - Even when VS-626VM3 or motor is grounded through its mountings such as channel base or steel plate, be sure to ground VS-626VM3 using the ground terminal E.
 - Where several VS-626VM3 units are used side by side, all the units should preferably be grounded directly to the ground poles. However, connecting all the ground terminals of VS-626VM3 in parallel, and ground only one of VS-626VM3 to the ground pole is also permissible (Fig. 4.14 (a)). However, do not form a loop with the ground leads (Fig 4.15 (b)).



(a) Good

(b) Poor

Fig. 4.14 Grounding of Three VS-626VM3 Units

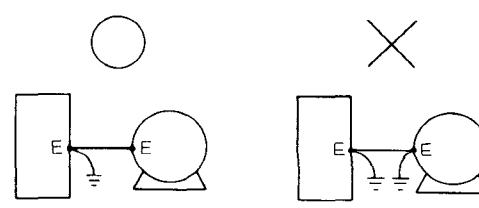

(a) Good

(b) Poor

Fig. 4.15 Grounding of Motor and VS-626VM3

- (4) Phase rotation of input terminals (R, S, T) is available to each direction, clockwise and counter clockwise.
- (5) Never connect power supply to output terminals (U, V, W).
 - ★ - If the power supply is connected to an output terminal, excess current flows and internal transistors may be damaged.
- (6) Connect inverter output terminals (U, V, and W) to corresponding motor terminals (U, V, and W).
 - ★ - Wrong Connection may cause motor buzzing and vibration, or improper rotation.
- (7) It is not guaranteed that failures are caused by grounding or short-circuiting of output cables. Be careful not to let cables come in contact with the casing.
- (8) Never connect phase advancing capacitors between the inverter and the motor. (Fig. 4.16.)
 - ★ - Inverter output overcurrent protection may be activated or the motor may hunt. Phase advance capacitors may be overheated or damaged by high-frequency component of inverter output voltage.

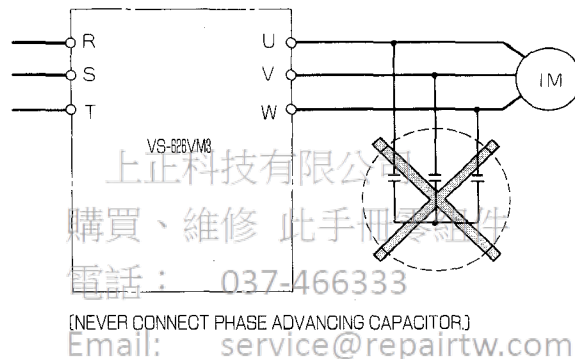

Fig. 4.16 Removal of Phase Advancing Capacitor

- (9) When a ground fault interrupter or leak relay is used, it must be well-balanced and placed in the power supply line as shown in Fig. 4.17.

Since output from the controller contains a high-frequency component, zero-phase current may flow through the electrostatic capacity-to-ground of the inverter-motor cable (C1) or the electrostatic capacity-to-ground of the motor (C2), improperly activating the ground fault interrupter. To avoid this, observe the following:

 - (a) Make the cable between the inverter and the motor as short as possible to reduce steady zero-phase current.
 - (b) Set a rated sensitivity current high.
 - (c) Use a ground fault interrupter for inverter or impulse wave inactive ground fault interrupter.

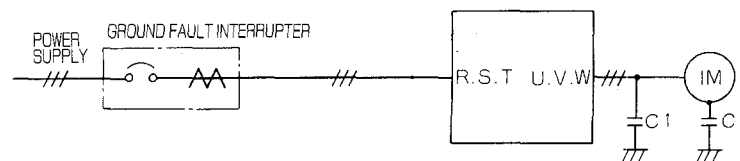

Fig. 4.17 Installation of Ground Fault Interrupter

- (10) If both the VS-626VM3 inverter and magnetic contactor are placed in the same control panel, the controller may sometimes operate erroneously due to the noise generated from the coil of the magnetic contactor. Connect a surge absorber in parallel with the coil of the magnetic contactor. The surge absorber will absorb the energy stored in the coil of magnetic contactor and thus must have a capacity suited to the coil. YASKAWA's magnetic contactors and surge absorbers are shown in Table 4.8.

CAUTION

Never connect surge absorbers to the output terminals (U, V, W) of the controller.

- ★ - If there is no surge absorber, making or breaking of the magnetic contactor generates surge voltage from the winding, disrupting the signal on the inverter control signal line.

Table 4.8 Surge Absorbers

Magnetic Contactor and Control Relay Type		Surge Absorber *		
		Type	Specifications	Code No.
200V Class	Magnetic-contactor† HI-10E, -20E, -25E, -35E, -50E, -65E ₂ , -80E ₂ , -125E ₂	DCR2-50A22E	250VAC 0.5 μF + 200 Ω	C002417
	Control Relay RA-6E ₂ , RL-33E†			
	Control Relay LY-2, -3‡ HH-22, -23# MM-2, -4‡	DCR2-10A25C	250VAC 0.5 μF + 200 Ω	C002482

* Made by MARCON Electronics Co., Ltd.
For contactors other than those listed above, use the following absorbers:
• For 200V class: Type DCR 2-50A22E
† Made by YASKAWA Control Co., Ltd.
‡ Made by Omron Corporation.
Made by Fuji Electric Co., Ltd.

- (11) To switch two or more motors by making or breaking of an magnetic contactor between the inverter and the motor as shown in Fig. 4.18, the circuit must be opened or closed when the motor stops and there is no current. To switch the motor, the encoder signal must also be switched.

- ★ - If the magnetic contactor is opened or closed during motor operation, overcurrent flows in the inverter and the motor, and the inverter may be damaged.

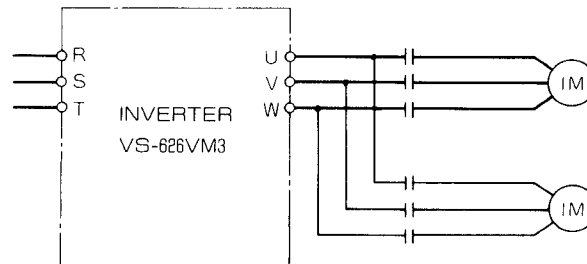

Fig. 4.18 Connection for Switching Motors

(12) The high-frequency components contained in the I/O (main circuit) of the inverter may cause radio frequency interference to nearby radios. If this occurs, the interference can be reduced by the use of a noise filter. It is also effective to run the power cables connecting the inverter to the motor and those that connecting the inverter to the power supply in grounded metal ducts. Fig. 4.19 shows an example of connecting a noise filter to the power supply. The recommended filter is described in Par. 5.5, "Noise Filter."

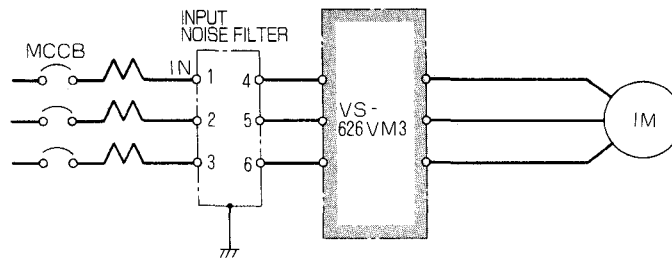

Fig. 4.19 Example of Connecting a Input Noise Filter

上正科技有限公司

購買、維修 此手冊零組件

電話： 037-466333

Email: service@repairtw.com

Line id: @zzzz

www.repairtw.com

4.8 CONTROL SIGNAL

4.8.1 Sequence Input Signal

For input signals, take the following conditions into consideration.

- (1) Possible input methods are 0V common, +24V common, and external common. Select one input by the selection connector on the controller (shown in Fig. 4.20).
- (2) Before changing the selection connector, turn off the power.
 - ★ - If the selection connector is changed when the control power supply is ON, the control power supply is short-circuited and the PC boards may be damaged.
- (3) Insert the selection connector so as to connect terminals in a column, namely 1 and 2, and 3 and 4. (See Fig. 4.21)
- ★ - If terminals in a line are connected, the +24V power supply is short-circuited and the PC boards may be damaged.
- (4) When the external common input method is selected, prepare a +24V power supply (20V to 26V) for the input signal.
- (5) When relay contacts, etc. are used, the contact capacity must be 30V or above (5mA or above).
- (6) The filter in the level shifter circuit in the input section causes approximately 5 ms delay in the signals.
- (7) Fig. 4.21 shows the input circuit, and Table 4.9 gives the signal functions.
- (8) The ON/OFF state of the input signal can be checked by control signal V1-09. See Fig. 4.22 for the display. See par. 13 for operation.

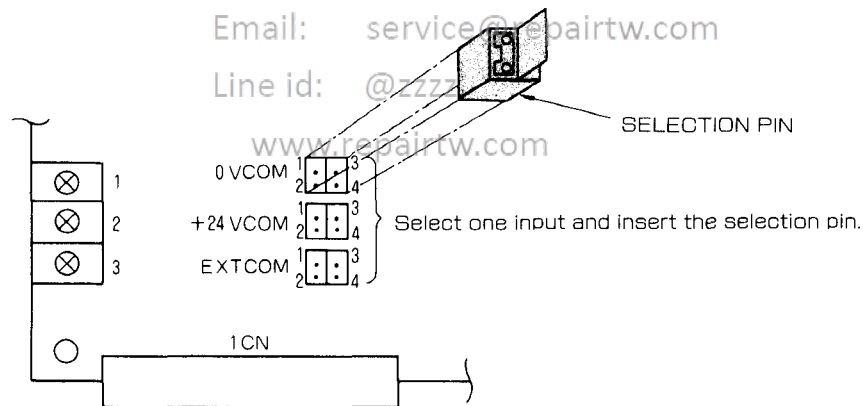

- ⚠ - Before changing the selection pin, turn off the power. Insert the selection pin in a position shown in the figure.

Fig. 4.20 Input Method Selection Pin

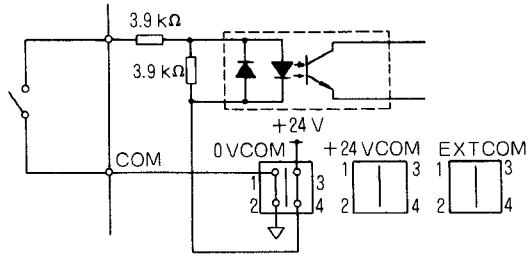

(a) 0V Common Input Method Interface

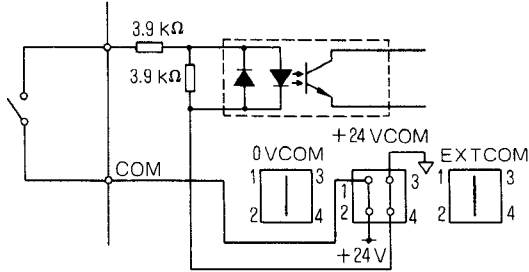

(b) +24V Common Input Method Interface

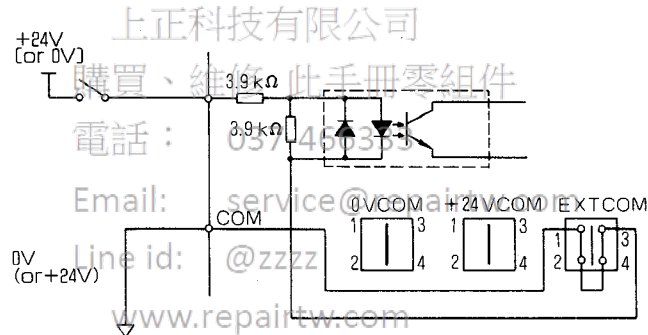

(c) Common Input Method Interface

Fig. 4.21 Input Interface Circuit

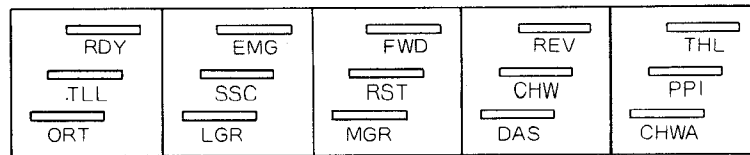

- Notes: 1. Input signal of "Closed Status" is indicated by lighting a lamp.
2. CHWA indicates the state of auxiliary contacts (3CN12-13).

Fig. 4.22 Display of Input Status

Table 4.9 Functions of Sequence Input Signals

Signal	Connector No.	Pin No.	On Signal	Function												
Ready RDY	1CN	6	CLOSE	<ul style="list-style-type: none"> If RDY is closed during operation, the base is immediately blocked to shut down motor current. Close RDY again to restart. By changing the selection signal C1-37 (SEL 2) Bit 3 and 2, RDY becomes the following status. “!” When RDY is opened during run, the motor will rapidly be stopped by regenerative braking. Then, the current is interrupted to open the MC. “!”: When RDY is opened during run, the motor will rapidly be stopped by regenerative braking. Then, the current is interrupted, but, MC is still closed. When RDY is not used and input method of 0 V common or +24V common is selected, connect 1CN-pin No.6 to pin No.20. When the external common input method is selected, always close RDY externally. 												
Forward Run FWD Reverse Run REV	1CN	8 9	CLOSE CLOSE	<ul style="list-style-type: none"> With RDY and EMG closed and the speed reference Positive, when FWD is closed, the motor runs CCW as viewed from drive end; and when REV is closed, the motor runs CW. Therefore, when speed reference and run signals are combined, the motor runs in the directions shown below. <table border="1" style="margin-left: auto; margin-right: auto;"> <thead> <tr> <th></th> <th>SPEED REFERENCE</th> <th>+</th> <th>-</th> </tr> </thead> <tbody> <tr> <td>Operation Signal</td> <td>FWD</td> <td>CCW</td> <td>CW</td> </tr> <tr> <td></td> <td>REV</td> <td>CW</td> <td>CCW</td> </tr> </tbody> </table> <ul style="list-style-type: none"> When the signal is opened during run, the motor is stopped by the regenerative braking and when the motor speed reaches to zero, the motor current is interrupted by gate blocking. The acceleration time is set with the soft start constants (C1-10 T_{SFS}). The time between halt and 100 % rated speed can be set between 0.1 and 180.0 seconds. However, for some load inertia values, the accel/decel time may be exceeded than the soft start set time. FWD and REV should be closed at least 15ms after EMG are closed. FWD and REV should not be closed before EMG and RDY. <div style="text-align: center;"> <p>The diagram shows three horizontal lines representing signals over time. The top line is labeled 'EMG' and has a box labeled 'CLOSED' starting at a certain point. The middle line is labeled 'RDY' and also has a box labeled 'CLOSED' starting at the same point. The bottom line is labeled 'FWD or REV' and has a box labeled 'CLOSED' that starts 15ms after the 'EMG' and 'RDY' boxes have begun. A double-headed arrow below this box indicates the 15ms delay.</p> </div> <ul style="list-style-type: none"> When both FWD and REV are closed, the motor stops. In this case, if whichever of them becomes open, the motor resumes running, so that care must be taken to avoid accident 		SPEED REFERENCE	+	-	Operation Signal	FWD	CCW	CW		REV	CW	CCW
	SPEED REFERENCE	+	-													
Operation Signal	FWD	CCW	CW													
	REV	CW	CCW													

Table 4.9 Functions of Sequence Input Signals (Cont'd)

Signal	Connector No.	Pin No.	On Signal	Function
Forward Run [FWD] Reverse Run [REV]	1CN	8 9	CLOSE CLOSE	<ul style="list-style-type: none"> When [FWD] or [REV] is closed, the motor runs at the speed specified by a speed reference. Be sure to first set a speed when running the motor.  <ul style="list-style-type: none"> When a trouble occurs during run, base is blocked immediately to interrupt the motor current. Open [FWD] and [REV] signals before turning power ON. If either [FWD] or [REV] is opened, motor cannot be started.
Emergency stop [EMG]	1CN	7	OPEN	<ul style="list-style-type: none"> Operation is ready within 2.5 seconds after closing [EMG]. During the delay time, the main circuit capacitor is charged. <p>Note: If the charge of the main circuit capacitor is performed several times during a short period, charging circuit may be easily deteriorated. Therefore, take sufficient time between the charges.</p> <ul style="list-style-type: none"> When [EMG] is opened during run, the motor is quickly stopped by regenerative braking, and then, the current is interrupted and MC is opened. Even when the motor is not stopped, the current is automatically interrupted after 10 seconds. After opening [EMG], operation will not be ready even after closing [EMG] again unless [FWD] and [REV] are opened. When [EMG] is not used and input method of 0V common or +24V common is selected, connect pin No.7 to pin No.19. When the external common input method is selected, always close [EMG] externally.
Torque limit [TLH] [TLL]	1CN	10 11	CLOSE CLOSE	<ul style="list-style-type: none"> These signals temporarily limit motor torque during operation. When [TLH] or [TLL] is closed, torque is limited. In this state, torque limiting signal [TLE] is output. The torque limit level when [TLH] is input can be set up for external operation torque limit level C1-24 (TL_{EXT}) from 5% to 120% of the 30-minute rating. [TLL] level is a half of [TLH]. Even if [TLH] and [TLL] are simultaneously closed, [TLL] will close before [TLH].  <ul style="list-style-type: none"> When [TLH] or [TLL] is not used, leave pin Nos.10 and 11 open.
Incremental Signal [INC]				<ul style="list-style-type: none"> This signal is used for incremental operation during orientation control. The [INC] signal is input to pin 11 when bit 0 and bit 1 of select signal C1-36 (SEL1) are set to "1" and "1", respectively. [INC] is effective when input simultaneously with or before [ORT]. If [INC] is input when power is turned ON or without absolute positioning, an incremental error (code: F-d15) occurs. When [ORT] is input after [INC], incremental operation is started from the stop position at that time. Therefore, absolute positioning must be performed in advance if positioning precision is required.

Table 4.9 Functions of Sequence Input Signals (Cont'd)

Signal	Connector No.	Pin No.	On Signal	Function																		
Soft-start Cancel SSC Servo Mode Signal SV	1CN	12	CLOSE ----- CLOSE	<ul style="list-style-type: none"> This signal is for cancelling the soft start function so that speed reference is changed by speed command without delay, for inching or other special control modes. When SSC is closed, the accel/decel set time is neglected, and the motor is accelerated or decelerated in short time by the current limit accel/decel function. When SSC is not to be used, leave pin No.12 open. <hr/> <ul style="list-style-type: none"> Selecting "1" on bit 3 of selection signal C1-36 (SEL1) permits change to servo mode for solid tap, etc. <p>SEL 1</p> <table style="margin-left: 40px;"> <tr> <td style="text-align: right;">Bit</td> <td>7</td><td>6</td><td>5</td><td>4</td><td>3</td><td>2</td><td>1</td><td>0</td> </tr> <tr> <td></td> <td> </td><td> </td><td> </td><td> </td><td> </td><td> </td><td> </td><td> </td> </tr> </table> <div style="margin-left: 40px;"> <p>└─ "1" : Soft start cancel at 1CN-12 "close"</p> <p>└─ "1" : Changes to Servo mode at 1CN-12 "close"</p> <p style="margin-left: 20px;">(The gain of speed loop, etc. changes to servo mode)</p> </div> <ul style="list-style-type: none"> The following control constants are effective only when servo mode is selected: <ul style="list-style-type: none"> Speed control ratio gain: C1-05, 07 Speed control integral time constant: C1-06, 08 Servo mode flux level: C1-31, 33 Servo mode base speed ratio: C1-32, 34 	Bit	7	6	5	4	3	2	1	0									
Bit	7	6	5	4	3	2	1	0														
Speed Regulator P/PI Selection PPI Load factor meter sensitivity 10-time LM10	1CN	15	CLOSE (P) OPEN (PI) ----- CLOSE	<ul style="list-style-type: none"> This signal is for selecting P/PI control of speed regulator. When PPI is closed, the speed controller switches to P control regardless of the operation state. When not performing P control, leave pin No.15 open. <hr/> <ul style="list-style-type: none"> This signal is used to increase sensitivity of the load factor meter ten times to improve the S/N ratio when load is light. The load meter 10-times switch signal is input by setting bit 4 of select signal C1-35 (SEL1) to "1" <p>SEL 1</p> <table style="margin-left: 40px;"> <tr> <td style="text-align: right;">Bit</td> <td>7</td><td>6</td><td>5</td><td>4</td><td>3</td><td>2</td><td>1</td><td>0</td> </tr> <tr> <td></td> <td> </td><td> </td><td> </td><td> </td><td> </td><td> </td><td> </td><td> </td> </tr> </table> <div style="margin-left: 40px;"> <p>└─ "1" : Select P control when 1CN-15 is closed.</p> <p>└─ "1" : increase sensitivity of the load meter ten times when 1CN-15 is closed.</p> </div>	Bit	7	6	5	4	3	2	1	0									
Bit	7	6	5	4	3	2	1	0														
Speed Reference Selection Signal DAS	1CN	5	OPEN (analog) ----- CLOSE (digital)	<ul style="list-style-type: none"> The type of speed reference input [analog input (10V/100%) or digital input] is selected with this signal. When DAS is opened, it is analog speed reference, and when it is closed, it is digital speed input. The following four can be selected for digital speed input. <ul style="list-style-type: none"> 12-bit binary (preset at the factory before delivery) 3-digit BCD 2-digit BCD Internal speed setting These selections are determined by selection signal C1 (SEL2). 																		

Table 4.9 Functions of Sequence Input Signals (Cont'd)

Signal	Connector No.	Pin No.	On Signal	Function
Alarm Reset RST	1CN	13	CLOSE ↓ OPEN	<ul style="list-style-type: none"> This signal is for restoring the run ready state after eliminating the cause of the tripping of the protective circuit, as the result of overcurrent or overload. RST is effective only after the tripping of a protecting circuit. While FWD or REV is closed, or ORT is closed, resetting is not possible. The RESET switch incorporated in the digital operator equivalent to this signal in function. Resetting is effected by RST edge signal. Therefore, close RST and open it. In the protective circuit sequence, malfunction has priority. An example of the timing chart for resetting is given below. <p>The timing chart shows the following sequence of events: 1. OVERLOAD PROTECTION (OL) signal is active (high). 2. FWD signal transitions from OPEN to CLOSE. 3. RST signal transitions from OPEN to CLOSE. 4. RUN signal transitions from OPEN to CLOSE. 5. FAULT INDICATION F-700 signal becomes active (high). 6. MALFUNCTION SIGNAL becomes active (high). 7. PROTECTIVE CIRCUIT TRIP occurs. 8. RST signal transitions from CLOSE to OPEN. 9. RESET END signal becomes active (high).</p>
Winding Selection CHW	1CN	14	CLOSE (low speed) OPEN (high speed)	<ul style="list-style-type: none"> This is a command signal of motor winding selection control. When CHW is opened, high-speed winding is selected. When it is closed, low-speed winding is selected. Windings can be selected even during operation. After winding selection is commanded by CHW, the gate is blocked until winding selection is completed. If this state continues over the set time, it is determined as a winding selection operation failure (code: F-100) and the machine is stopped. <p>The timing chart shows the following sequence of events: 1. CHW signal transitions from OPEN to CLOSE. 2. HIGH-SPEED WINDING signal becomes active (high). 3. CHW signal transitions from CLOSE to OPEN. 4. LOW-SPEED WINDING signal becomes active (high). 5. CHW signal transitions from OPEN to CLOSE. 6. GATE BLOCK signal becomes active (high).</p>

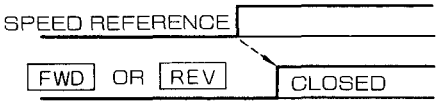
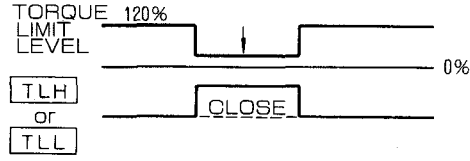
Table 4.9 Functions of Sequence Input Signals (Cont'd)

Signal	Connector No.	Pin No.	On Signal	Function															
Orientation [ORT]	1CN	16	CLOSE	<ul style="list-style-type: none"> This is a command signal of electric orientation. When [ORT] is input, the spindle is immediately moved and stopped at a specified position. Open [ORT] when replacement of a tool or workpiece, or any other work has been performed in the positioned state. If an emergency stop occurred during orientation, operation cannot be restarted unless [ORT] is opened. Open [ORT] before turning power ON. Otherwise, operation cannot be started. If there is no orientation card (option), use the motor encoder signal for positioning. When [ORT] is not to be used, disconnect pin 16. 															
M Gear Selection Signal [MGR]		18	L (CLOSE)	<ul style="list-style-type: none"> These signals change parameters such as gear ratio and gain to optimize control according to gear selection of the spindle. Use the gear select signals as listed in the table below. <table border="1" style="margin-left: auto; margin-right: auto;"> <thead> <tr> <th>MGR</th> <th>LGR</th> <th>Function</th> </tr> </thead> <tbody> <tr> <td>H</td> <td>H</td> <td>H-gear selection</td> </tr> <tr> <td>L</td> <td>H</td> <td>M-gear selection</td> </tr> <tr> <td>H</td> <td>L</td> <td>L-gear selection</td> </tr> <tr> <td>L</td> <td>L</td> <td>M-gear selection</td> </tr> </tbody> </table>	MGR	LGR	Function	H	H	H-gear selection	L	H	M-gear selection	H	L	L-gear selection	L	L	M-gear selection
MGR		LGR	Function																
H	H	H-gear selection																	
L	H	M-gear selection																	
H	L	L-gear selection																	
L	L	M-gear selection																	
L Gear Selection Signal [LGR]		17	L (CLOSE)																

Line id: @zzzz

www.repairtw.com
Table 4.10 Gear Selection by Gear Ratio

Number of Speeds	Gear Ratio	Gear Ratio (= $\frac{\text{Spindle Speed}}{\text{Motor Speed}}$)	Gear Selection	
			M Gear (MGR)	L Gear (LGR)
1	—	$\frac{2.5}{0.6}$	×	×
	—	$\frac{0.8}{0.15}$	○	×
	—	$\frac{0.6}{0.05}$	×	○
2	HIGH	$\frac{2.5}{0.6}$	×	×
	LOW	$\frac{0.8}{0.15}$	○	×
	HIGH	$\frac{2.5}{0.6}$	×	×
	LOW	$\frac{0.6}{0.05}$	×	○
	HIGH	$\frac{0.8}{0.15}$	○	×
	LOW	$\frac{0.6}{0.05}$	×	○
3	HIGH	$\frac{2.5}{0.6}$	×	×
	MEDIUM	$\frac{0.8}{0.15}$	○	×
	LOW	$\frac{0.6}{0.05}$	×	○

Note: Consult the company on the other combinations of gear ratio.

○...ON, contact closed
×...OFF, contact open

4.8.2 Speed Reference

Table 4.11 Speed Reference Input

Signal	Connector No.	Pin No.	Function
Analog Speed Reference SCOM	1CN	3	<ul style="list-style-type: none"> Rated input voltage is $\pm 10\text{VDC}$. If the maximum motor speed cannot be obtained at rated input voltage, it can be adjusted by motor speed adjustment constant C1-12 (SADJ). The allowable input voltage is $\pm 12\text{VDC}$. However, since the controller limits it at 105% or 110% of rated value, the maximum speed of the motor is limited at 105% or 110% of the rated speed. Select the level of speed limit by bit 5 of select signal C1-38 (SEL3). When "1" is set for the bit 5, 105% is set up. When "0" is set, 110% is set up. The input impedance of SCOM is $50\text{ k}\Omega$. With various combinations of SCOM and run signals, speeds and directions of rotation shown below are obtained. <ul style="list-style-type: none"> SCOM is effective and the motor runs when run signal FWD or REV is closed. If SCOM is set to 0V while forward or reverse run signal is being input, the motor may fail to stop completely. To stop the motor completely, open both the forward and reverse run signals. (While either is closed, current flows.) To improve noise resistance, use shielded lead for the SCOM circuit. When setting SCOM manually, the reference voltage (+15V) of the controller can be used, provided the current is kept up to 10 mA.

Table 4.11 Speed Reference Input (Cont'd)

Signal	Connector No.	Pin No.	Function																																																										
Digital Speed Reference D1~D12	2CN	1 to 12	<ul style="list-style-type: none"> Two types of speed settings (Internal speed setting and digital speed setting) can be selected. The following four can be selected for digital speed inputs (preset at the factory before delivery is 12-bit binary) . <ul style="list-style-type: none"> 12-bit binary 3-digit BCD 2-digit BCD Internal speed setting To select digital speed reference setup method, use bits 6 and 7 of select signal C1-37 (SEL2) . <p>SEL2</p> <div style="text-align: center;"> <p>Bit</p> <table style="margin-left: auto; margin-right: auto;"> <tr> <td style="padding: 0 5px;">7</td><td style="padding: 0 5px;">6</td><td style="padding: 0 5px;">5</td><td style="padding: 0 5px;">4</td><td style="padding: 0 5px;">3</td><td style="padding: 0 5px;">2</td><td style="padding: 0 5px;">1</td><td style="padding: 0 5px;">0</td> </tr> <tr> <td style="text-align: center;"> </td><td style="text-align: center;"> </td><td style="text-align: center;"> </td><td style="text-align: center;"> </td><td style="text-align: center;"> </td><td style="text-align: center;"> </td><td style="text-align: center;"> </td><td style="text-align: center;"> </td> </tr> <tr> <td style="text-align: center;"> </td><td style="text-align: center;"> </td><td style="text-align: center;"> </td><td style="text-align: center;"> </td><td style="text-align: center;"> </td><td style="text-align: center;"> </td><td style="text-align: center;"> </td><td style="text-align: center;"> </td> </tr> <tr> <td colspan="2" style="text-align: center;">└───┘</td><td></td><td></td><td></td><td></td><td></td><td></td> </tr> </table> </div> <p style="text-align: center;">Selection of Speed Settings</p> <table border="1" style="width: 100%; border-collapse: collapse;"> <thead> <tr> <th rowspan="2">1 CN- 5 ,19 DAS</th> <th colspan="2">SEL 2 (C 1 -37)</th> <th rowspan="2">Speed Setting</th> </tr> <tr> <th>Bit 7</th> <th>Bit 6</th> </tr> </thead> <tbody> <tr> <td>Open</td> <td style="text-align: center;">-</td> <td style="text-align: center;">-</td> <td>Analog speed setting</td> </tr> <tr> <td>Closed</td> <td style="text-align: center;">" 1 "</td> <td style="text-align: center;">" 1 "</td> <td>2 -digit BCD</td> </tr> <tr> <td>Closed</td> <td style="text-align: center;">" 1 "</td> <td style="text-align: center;">" 0 "</td> <td>Binary</td> </tr> <tr> <td>Closed</td> <td style="text-align: center;">" 0 "</td> <td style="text-align: center;">" 1 "</td> <td>3 -digit BCD</td> </tr> <tr> <td>Closed</td> <td style="text-align: center;">" 0 "</td> <td style="text-align: center;">" 0 "</td> <td>Internal Speed Setting</td> </tr> </tbody> </table> <ul style="list-style-type: none"> For digital speed (binary, BCD) and internal speed setting, forward and reverse run are selected by contact signal of FOR • REV externally. 	7	6	5	4	3	2	1	0																	└───┘								1 CN- 5 ,19 DAS	SEL 2 (C 1 -37)		Speed Setting	Bit 7	Bit 6	Open	-	-	Analog speed setting	Closed	" 1 "	" 1 "	2 -digit BCD	Closed	" 1 "	" 0 "	Binary	Closed	" 0 "	" 1 "	3 -digit BCD	Closed	" 0 "	" 0 "	Internal Speed Setting
7	6	5	4	3	2	1	0																																																						
└───┘																																																													
1 CN- 5 ,19 DAS	SEL 2 (C 1 -37)		Speed Setting																																																										
	Bit 7	Bit 6																																																											
Open	-	-	Analog speed setting																																																										
Closed	" 1 "	" 1 "	2 -digit BCD																																																										
Closed	" 1 "	" 0 "	Binary																																																										
Closed	" 0 "	" 1 "	3 -digit BCD																																																										
Closed	" 0 "	" 0 "	Internal Speed Setting																																																										

上正科技有限公司
 購買、維修、零件、組件
 電話： 037-466333
 Email: service@repairtw.com
 Line id: @zzzz

Table 4.11 Speed Reference Input (Cont'd)

Signal	Connector No.	Pin No.	Function																																																														
Digitl Speed Input D1~D12	2CN	1 to 12	<ul style="list-style-type: none"> Internal speed setting Speed setting number : 8 steps Setting value : % setting for rated speed setting C1-26 (S 100) is input in C 1 -41 to 48 (0.00 to 100.00) 																																																														
			<table border="1"> <thead> <tr> <th>Control Constants</th> <th>Symbol</th> <th>Internal Speed Setting</th> <th>2CN Input</th> </tr> </thead> <tbody> <tr> <td>C 1 -41</td> <td>SPD 1</td> <td>1</td> <td>D 1</td> </tr> <tr> <td>C 1 -42</td> <td>SPD 2</td> <td>2</td> <td>D 2</td> </tr> <tr> <td>C 1 -43</td> <td>SPD 3</td> <td>3</td> <td>D 3</td> </tr> <tr> <td>C 1 -44</td> <td>SPD 4</td> <td>4</td> <td>D 4</td> </tr> <tr> <td>C 1 -45</td> <td>SPD 5</td> <td>5</td> <td>D 5</td> </tr> <tr> <td>C 1 -46</td> <td>SPD 6</td> <td>6</td> <td>D 6</td> </tr> <tr> <td>C 1 -47</td> <td>SPD 7</td> <td>7</td> <td>D 7</td> </tr> <tr> <td>C 1 -48</td> <td>SPD 8</td> <td>8</td> <td>D 8</td> </tr> </tbody> </table>	Control Constants	Symbol	Internal Speed Setting	2CN Input	C 1 -41	SPD 1	1	D 1	C 1 -42	SPD 2	2	D 2	C 1 -43	SPD 3	3	D 3	C 1 -44	SPD 4	4	D 4	C 1 -45	SPD 5	5	D 5	C 1 -46	SPD 6	6	D 6	C 1 -47	SPD 7	7	D 7	C 1 -48	SPD 8	8	D 8																										
			Control Constants	Symbol	Internal Speed Setting	2CN Input																																																											
			C 1 -41	SPD 1	1	D 1																																																											
			C 1 -42	SPD 2	2	D 2																																																											
			C 1 -43	SPD 3	3	D 3																																																											
			C 1 -44	SPD 4	4	D 4																																																											
			C 1 -45	SPD 5	5	D 5																																																											
			C 1 -46	SPD 6	6	D 6																																																											
			C 1 -47	SPD 7	7	D 7																																																											
			C 1 -48	SPD 8	8	D 8																																																											
			<ul style="list-style-type: none"> When the plural speed selecting contacts turn ON simultaneously, lower speed setting No. is available. When all speed selecting contacts turn OFF, speed setting is 0. During operation, setting constants (C 1 -41 to 48) cannot be selected. External digital speed setting. 																																																														
<table border="1"> <thead> <tr> <th>Signal</th> <th>Pin No.</th> <th>12-bit Binary</th> <th>3-digit BCD</th> <th>2-digit BCD</th> </tr> </thead> <tbody> <tr> <td>D 1</td> <td>1</td> <td>1</td> <td>1</td> <td>—</td> </tr> <tr> <td>D 2</td> <td>2</td> <td>2</td> <td>2</td> <td>—</td> </tr> <tr> <td>D 3</td> <td>3</td> <td>4</td> <td>4</td> <td>—</td> </tr> <tr> <td>D 4</td> <td>4</td> <td>8</td> <td>8</td> <td>—</td> </tr> <tr> <td>D 5</td> <td>5</td> <td>16</td> <td>10</td> <td>1</td> </tr> <tr> <td>D 6</td> <td>6</td> <td>32</td> <td>20</td> <td>2</td> </tr> <tr> <td>D 7</td> <td>7</td> <td>64</td> <td>40</td> <td>4</td> </tr> <tr> <td>D 8</td> <td>8</td> <td>128</td> <td>80</td> <td>8</td> </tr> <tr> <td>D 9</td> <td>9</td> <td>256</td> <td>100</td> <td>10</td> </tr> <tr> <td>D 10</td> <td>10</td> <td>512</td> <td>200</td> <td>20</td> </tr> <tr> <td>D 11</td> <td>11</td> <td>1024</td> <td>400</td> <td>40</td> </tr> <tr> <td>D 12</td> <td>12</td> <td>2048</td> <td>800</td> <td>80</td> </tr> </tbody> </table>	Signal	Pin No.	12-bit Binary	3-digit BCD	2-digit BCD	D 1	1	1	1	—	D 2	2	2	2	—	D 3	3	4	4	—	D 4	4	8	8	—	D 5	5	16	10	1	D 6	6	32	20	2	D 7	7	64	40	4	D 8	8	128	80	8	D 9	9	256	100	10	D 10	10	512	200	20	D 11	11	1024	400	40	D 12	12	2048	800	80
Signal	Pin No.	12-bit Binary	3-digit BCD	2-digit BCD																																																													
D 1	1	1	1	—																																																													
D 2	2	2	2	—																																																													
D 3	3	4	4	—																																																													
D 4	4	8	8	—																																																													
D 5	5	16	10	1																																																													
D 6	6	32	20	2																																																													
D 7	7	64	40	4																																																													
D 8	8	128	80	8																																																													
D 9	9	256	100	10																																																													
D 10	10	512	200	20																																																													
D 11	11	1024	400	40																																																													
D 12	12	2048	800	80																																																													
<ul style="list-style-type: none"> 12-bit Binary becomes the rated speed input reference when all signals are closed. 3-digit and 2-digit BCD become the rated speed input reference at 999 and 99 respectively. 																																																																	

Note: The input signal circuit of digital speed input is the same as that of Par, 5.8.1 "Sequense Input Signal".

Table 4.11 Speed Reference Input (Cont'd)

Signal Name	Connector No.	Pin No.	Description																																																																																																																																														
Stop Position Reference Signal D1 to D12	2CN	1 to 12	<ul style="list-style-type: none"> This is a stop position reference when arbitrary-position stop control is performed by motor encoder. D1 to D2 becomes the stop position reference by setting the bit 7 of select signal C1-36 (SEL 1) to "1". <div style="text-align: center;"> <p>SEL 1</p> <table style="border-collapse: collapse; margin: auto;"> <tr> <td style="padding: 0 5px;">Bit</td> <td style="padding: 0 5px;">7</td> <td style="padding: 0 5px;">6</td> <td style="padding: 0 5px;">5</td> <td style="padding: 0 5px;">4</td> <td style="padding: 0 5px;">3</td> <td style="padding: 0 5px;">2</td> <td style="padding: 0 5px;">1</td> <td style="padding: 0 5px;">0</td> </tr> <tr> <td style="padding: 0 5px;"></td> <td style="text-align: center;"> </td> <td style="text-align: center;"> </td> <td style="text-align: center;"> </td> <td style="text-align: center;"> </td> <td style="text-align: center;"> </td> <td style="text-align: center;"> </td> <td style="text-align: center;"> </td> <td style="text-align: center;"> </td> </tr> <tr> <td style="padding: 0 5px;"></td> <td style="text-align: center;"> </td> <td style="text-align: center;"> </td> <td style="text-align: center;"> </td> <td style="text-align: center;"> </td> <td style="text-align: center;"> </td> <td style="text-align: center;"> </td> <td style="text-align: center;"> </td> <td style="text-align: center;"> </td> </tr> </table> <div style="display: flex; justify-content: center; gap: 20px;"> <div style="text-align: center;"> <p>→ "1" : 2CN D1 to D2 digital speed reference</p> </div> <div style="text-align: center;"> <p>→ "1" : 2CN D1 to D2 stop position reference</p> </div> </div> </div> <ul style="list-style-type: none"> This is a stop position reference which is input externally with the spindle home position assumed as 0 (Zero). For position reference, either a 12-bit binary or 3-digit BCD may be selected. <table border="1" style="width: 100%; border-collapse: collapse; margin: 10px 0;"> <thead> <tr> <th rowspan="2">Absolute</th> <th>Binary</th> <th>Data 12-bit</th> <th>0° to 359.9° (000H to FFH)</th> </tr> </thead> <tbody> <tr> <td>BCD</td> <td>Code 1-bit Data 3-digit (11-bit)</td> <td>-θ to +θ (-799D to +799D)</td> </tr> <tr> <th rowspan="2">Incremental</th> <th>Binary</th> <td>Code 1-bit Data 11-bit</td> <td>-180° to 179.9° (000H to 7FFH)</td> </tr> <tr> <td>BCD</td> <td>Code 1-bit Data 3-digit (11-bit)</td> <td>-θ to +θ (-799D to +799D)</td> </tr> </tbody> </table> <ul style="list-style-type: none"> Sign bit is - (minus) if in the ON state and + (plus) if in the OFF state. θ can be obtained as a product of the data of 3-digit BCD and C2-12 (PBCD), the BCD stop position reference resolution. (θ < 360°) The relation between Command signals and number of pulses are shown in the following table. <table border="1" style="width: 100%; border-collapse: collapse; margin: 10px 0;"> <thead> <tr> <th rowspan="2">Bit</th> <th rowspan="2">Pin</th> <th colspan="2">Binary</th> <th>BCD</th> </tr> <tr> <th>Without Code</th> <th>With Code</th> <th>With Code</th> </tr> </thead> <tbody> <tr><td>1</td><td>1</td><td>1</td><td>1</td><td>1</td></tr> <tr><td>2</td><td>2</td><td>2</td><td>2</td><td>2</td></tr> <tr><td>3</td><td>3</td><td>4</td><td>4</td><td>4</td></tr> <tr><td>4</td><td>4</td><td>8</td><td>8</td><td>8</td></tr> <tr><td>5</td><td>5</td><td>16</td><td>16</td><td>10</td></tr> <tr><td>6</td><td>6</td><td>32</td><td>32</td><td>20</td></tr> <tr><td>7</td><td>7</td><td>64</td><td>64</td><td>40</td></tr> <tr><td>8</td><td>8</td><td>128</td><td>128</td><td>80</td></tr> <tr><td>9</td><td>9</td><td>256</td><td>256</td><td>100</td></tr> <tr><td>10</td><td>18</td><td>512</td><td>512</td><td>200</td></tr> <tr><td>11</td><td>19</td><td>1024</td><td>1024</td><td>400</td></tr> <tr><td>12</td><td>20</td><td>2048</td><td>Code</td><td>Code</td></tr> </tbody> </table> <ul style="list-style-type: none"> In the case of binary-coded decimal notation, the content of the signal varies with the polarity of the code. <p><If it is ON> Sum of number of pulses of the bits that are input.</p> <div style="text-align: center; margin: 10px 0;"> <table style="border-collapse: collapse; margin: auto;"> <tr> <td style="padding: 0 5px;">0</td><td style="padding: 0 5px;">0</td><td style="padding: 0 5px;">1</td><td style="padding: 0 5px;">0</td><td style="padding: 0 5px;">1</td><td style="padding: 0 5px;">0</td><td style="padding: 0 5px;">0</td><td style="padding: 0 5px;">1</td><td style="padding: 0 5px;">0</td><td style="padding: 0 5px;">0</td><td style="padding: 0 5px;">1</td> </tr> <tr> <td style="text-align: center;">⋮</td><td style="text-align: center;">⋮</td><td style="text-align: center;">⋮</td><td style="text-align: center;">⋮</td><td style="text-align: center;">⋮</td><td style="text-align: center;">⋮</td><td style="text-align: center;">⋮</td><td style="text-align: center;">⋮</td><td style="text-align: center;">⋮</td><td style="text-align: center;">⋮</td><td style="text-align: center;">⋮</td> </tr> <tr> <td colspan="11" style="text-align: center;">256+64 + 8 + 1 =329</td> </tr> </table> </div> <p><If it is OFF> Complement of the number of pulses of the bits that are input. - (256+64+3+1) = -329</p> <ul style="list-style-type: none"> In the case of incremental, motions exceeding 180° are not available in the binary notation. However, in the case of BCD reference, depending on the setting of BCD stop position reference C2-12 (PBCD) reference exceeding 180° (upto ±360° maximum) are available. 	Bit	7	6	5	4	3	2	1	0																			Absolute	Binary	Data 12-bit	0° to 359.9° (000H to FFH)	BCD	Code 1-bit Data 3-digit (11-bit)	-θ to +θ (-799D to +799D)	Incremental	Binary	Code 1-bit Data 11-bit	-180° to 179.9° (000H to 7FFH)	BCD	Code 1-bit Data 3-digit (11-bit)	-θ to +θ (-799D to +799D)	Bit	Pin	Binary		BCD	Without Code	With Code	With Code	1	1	1	1	1	2	2	2	2	2	3	3	4	4	4	4	4	8	8	8	5	5	16	16	10	6	6	32	32	20	7	7	64	64	40	8	8	128	128	80	9	9	256	256	100	10	18	512	512	200	11	19	1024	1024	400	12	20	2048	Code	Code	0	0	1	0	1	0	0	1	0	0	1	⋮	⋮	⋮	⋮	⋮	⋮	⋮	⋮	⋮	⋮	⋮	256+64 + 8 + 1 =329										
Bit	7	6	5	4	3	2	1	0																																																																																																																																									
Absolute	Binary	Data 12-bit	0° to 359.9° (000H to FFH)																																																																																																																																														
	BCD	Code 1-bit Data 3-digit (11-bit)	-θ to +θ (-799D to +799D)																																																																																																																																														
Incremental	Binary	Code 1-bit Data 11-bit	-180° to 179.9° (000H to 7FFH)																																																																																																																																														
	BCD	Code 1-bit Data 3-digit (11-bit)	-θ to +θ (-799D to +799D)																																																																																																																																														
Bit	Pin	Binary		BCD																																																																																																																																													
		Without Code	With Code	With Code																																																																																																																																													
1	1	1	1	1																																																																																																																																													
2	2	2	2	2																																																																																																																																													
3	3	4	4	4																																																																																																																																													
4	4	8	8	8																																																																																																																																													
5	5	16	16	10																																																																																																																																													
6	6	32	32	20																																																																																																																																													
7	7	64	64	40																																																																																																																																													
8	8	128	128	80																																																																																																																																													
9	9	256	256	100																																																																																																																																													
10	18	512	512	200																																																																																																																																													
11	19	1024	1024	400																																																																																																																																													
12	20	2048	Code	Code																																																																																																																																													
0	0	1	0	1	0	0	1	0	0	1																																																																																																																																							
⋮	⋮	⋮	⋮	⋮	⋮	⋮	⋮	⋮	⋮	⋮																																																																																																																																							
256+64 + 8 + 1 =329																																																																																																																																																	

4.8.3 Sequence Output Signal

Use these output signals under the following conditions.

- (1) Both +24V common and 0V common are available output methods.
- (2) Signal output is insulated by a photocoupler. Prepare +24V power supply to output signals.
- (3) When 24V is applied, the output current capacity is up to 50mA.
- (4) When an inductive load such as an external relay is to be switched on and off, be sure to connect a spark suppressor in parallel with the load. The maximum allowable voltage for the output circuit is 26V.
- ★ - If greater voltage than the maximum allowable is applied, the photocoupler of the output circuit may be damaged.
- (5) For a capacitive load, connect a protective resistor in series with the load to limit the current.
- ★ - If there is no protective resistor, excess current flows when the photocoupler is operated, and the components may be damaged.
- (6) Fig. 4.23 shows the output circuit. Table 4.12 lists the functions of signals.
- (7) The ON/OFF state of the output signals can be checked by control signal V1-10. The status is displayed on the digital operator LEDs as shown in Fig. 4.24.

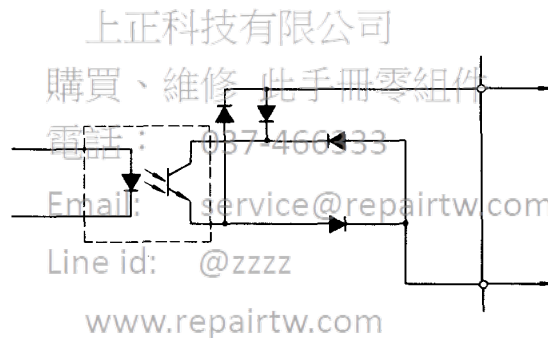
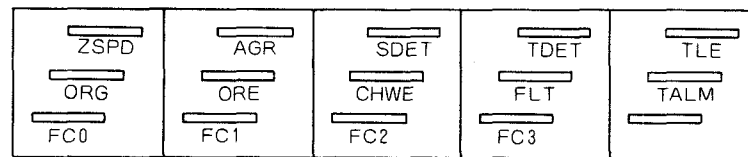

Fig. 4.23 Output Interface Circuit



Note: Output signal of closed status are indicated by the lamps.

Fig. 4.24 Display of Output State

Table 4.12 Functions of Sequence Output Signals

Signal	Connector No.	Contact and Pin No.	Function
Zero Speed ZSPD	1CN		<ul style="list-style-type: none"> When the motor speed drops below the set level, ZSPD is closed. Once ZSPD is closed, it remains closed for 50 ms.  <ul style="list-style-type: none"> The zero-speed detection level can be set up for control constant C1-19 (ZSLVL) from 3 r/min. to 60 r/min. Since ZSPD is output irrespective of FWD and REV, it can be used as a safety run interlock signal.
Speed Agreed AGR	1CN		<ul style="list-style-type: none"> When the motor speed enters the preset range of SCOM, AGR closes. However, in gateblock status, it is not output. Once AGR is closed, it remains closed for 50 ms. When this signal is used as an answer to S command in NC program operation, the program is advanced to the next step. Speed agreed signal setting range of $\pm 10\%$ to $\pm 50\%$ of rated speed is selected with speed agreed signal detection width C1-20 (AGR_{BD}). <p>Operation Example of speed agreed signal</p>  <p>SPEED REFERENCE-MOTOR SPEED C1-20 = 15%</p>
Speed Detection SDET	1CN		<ul style="list-style-type: none"> When the motor speed drops below a preset level, SDET is closed. The speed detection level is set between 0 and 100% speed with the preset constants C1-21 (SDLVL)  <ul style="list-style-type: none"> Hysteresis width is set in the control constants C1-22 (SD_{HYS}) SDET operates regardless of the run direction signals.

Table 4.12 Functions of Sequence Output Signals (Cont'd)

Signal	Connector No.	Contact and Pin No.	Function
Torque Detection TDET	1CN		<ul style="list-style-type: none"> When torque decreases below a specified level, TDET is closed. The torque detection level can be set between 5 and 120% of 30-minute rating with the control constants C1-23 (TD) TDET can be used as a signal for checking the torque limit function, and for determining the load conditions.
Torque Limit TLE	1CN		<ul style="list-style-type: none"> When external torque limit TLL or TLH is input, TLE will be closed. TLE can be used as check signal for TLL and TLH .
Winding Selection Completed CHWE	1CN		<ul style="list-style-type: none"> This is the completion signal of motor winding selection. CHWE is closed during normal operation. When CHW is commanded, CHWE is opened until the winding has been completed. After completion, the signal is closed again. If CHWE is not output within a set time after CHW is input, it is assumed to be a winding selection operation failure (code: F-000) and the operation is stopped. During winding selection, AGR is also opened (provided that selection is started when the machine is operating at a constant speed) . <div style="text-align: center;">  <p>WINDING HIGH-SPEED WINDING LOW-SPEED WINDING</p> <p>CHW CLOSE</p> <p>CHWE CLOSE CLOSE</p> <p>AGR CLOSE CLOSE</p> </div>
Orientation Completed ORE	1CN		<ul style="list-style-type: none"> ORE is closed when the spindle reached near the commanded stop position after ORT is input. While ORE is closed, resistant torque is generated against external force to compensate for positioning error. Therefore, tools and workpieces must be replaced while ORE is closed. If a great external force is applied and positioning error is increased, ORE is opened. Prepare an external sequence to judge it to be an orientation failure.
Spindle Home Position ORG	1CN		<ul style="list-style-type: none"> One pulse is output per one rotation of the spindle using the magnetic sensor signal. ORG is output when spindle runs at 1000 r/min. or less.

Table 4.12 Functions of Sequence Output Signals (Cont'd)

Signal	Connector No.	Contact and Pin No.	Function
Fault FLT	1CN		<ul style="list-style-type: none"> • When protective circuit for overcurrent or overload tripped, the motor current is instantly interrupted, and the motor stops after running by inertia. Upon current interruption, FLT is output. • The FLT relay is closed at protective circuit operation. The contact is NONC contact. • While FLT is being output, open operation signal FWD or REV and output a failure warning to the main system. • FLM is displayed. • For the relationship between FLT and RST, refer to Table 4.9.
Protect Function Code FC 0 FC 1 FC 2 FC 3	1CN		<ul style="list-style-type: none"> • The contents of the protective function operation is output by the protective function code signal. • The contents of the protective function codes are in Table 13.7.
Abnormality Alarm TALM	1CN		<ul style="list-style-type: none"> • TALM is output if motor overheating, controller overheating, or temperature rise in the control panel is detected. Operation is continued. • Under the following conditions, TALM outputs a failure signal, shutting down current to stop the machine. Motor overheating lasted one minute or longer. (Code : F 900→F 901) • Heatsink overheating lasted one minute or longer. (Code : F 903→F 904) • Control panel inside temperature exceeded 60°C. (Code : F 906→F 907) • Light fault of optional function such as orientation also outputs as TALM.

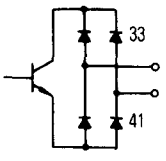
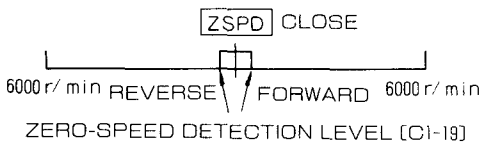
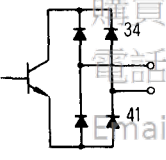
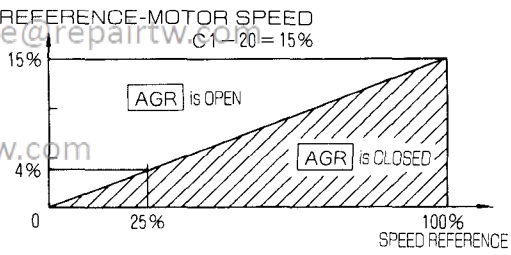
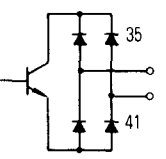
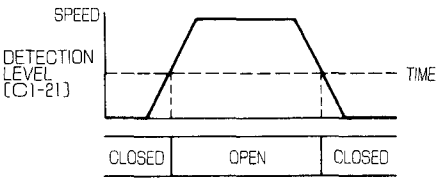
4.8.4 Encoder Pulse Output Circuit

[PAO *PAO PBO *PBO PCO *PCO] * indicates a reverse signal.

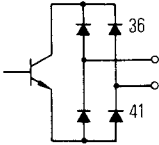
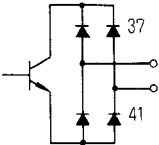
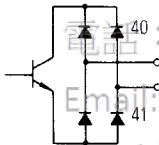
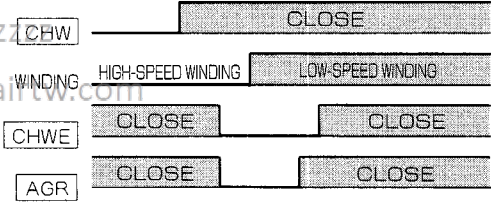
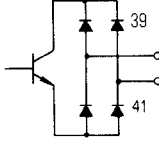
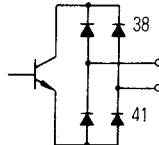
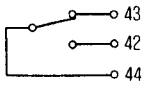
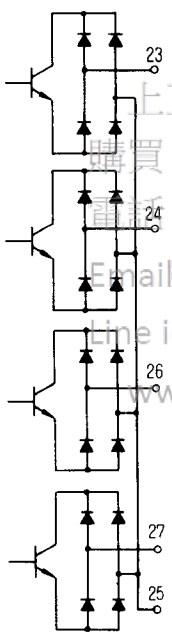
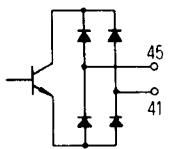
Encoders having home position signals (1024 pulses/rev) outputs phase-A, phase-B, and phase-C (home position) signals.

These signals can be used for position feedback signals. Specifications of output signals are as follows:

(1) Signal form

- Two-phase pulse with 90° pulse difference (phase A and B)
- Original point pulse (phase C)

(2) Output circuit and receiver circuit

The output circuit is a line driver in compliance with the RS-422-A specifications. Use line receivers of matched characteristics to convert the signals as shown in the connection circuit example in Fig. 4.25.

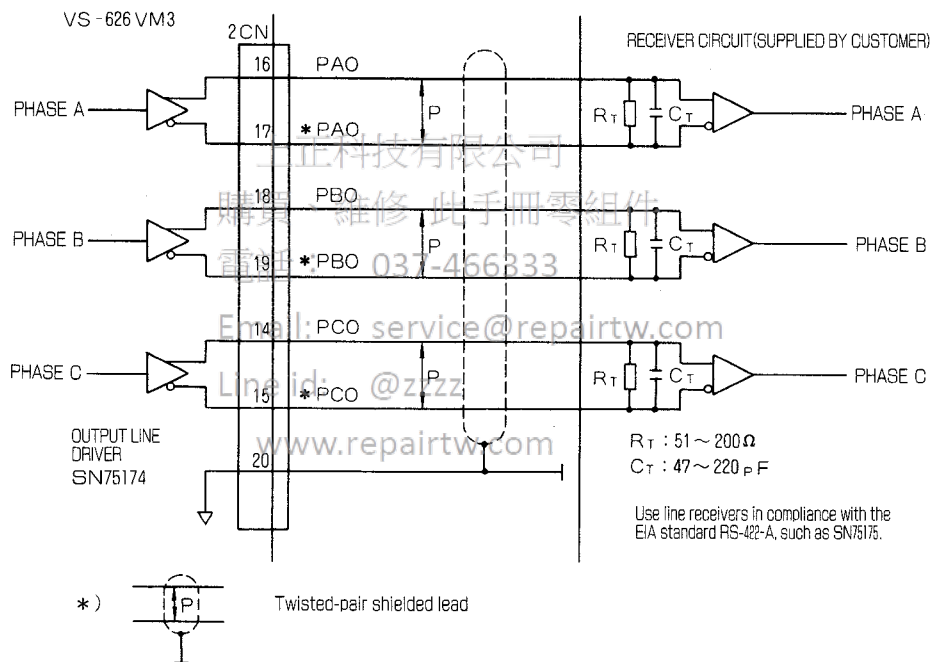

Fig. 4.25 Output Circuit and Receiver circuit

(3) Output phase

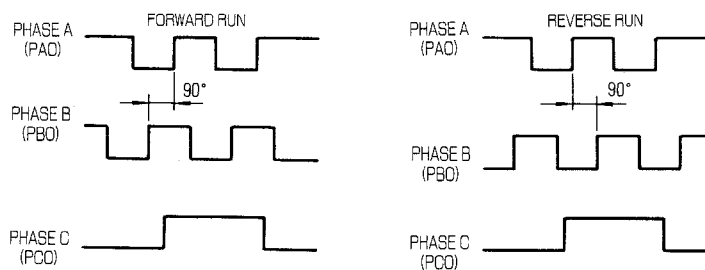

Fig. 4.26 Output Phase

4.8.5 Analog Monitor Signal

Use the analog output signals in the following conditions.

Table 4.13 Functions of Analog Output Signals

Signal	Connector No.	Pin No.	Function												
Speedometer SM	1CN or Screw Terminal No.1	47	<ul style="list-style-type: none"> When an external speedometer is connected, the motor speed can be monitored. Speedometer signal terminal outputs DC voltage signal proportional to the motor speed, regardless of the run direction. Select a voltmeter as a speedometer which satisfies the following specifications. <table border="1" style="width: 100%; border-collapse: collapse;"> <thead> <tr> <th>Item</th> <th>Specifications</th> </tr> </thead> <tbody> <tr> <td>Name</td> <td>Voltmeter</td> </tr> <tr> <td>Activation</td> <td>Moving coil type</td> </tr> <tr> <td>Rating</td> <td>10 V full-scale</td> </tr> <tr> <td>Internal Resistance</td> <td>10 kΩ</td> </tr> <tr> <td>Class</td> <td>2.5 class or above</td> </tr> </tbody> </table> <ul style="list-style-type: none"> The level of speedometer signal is adjustable with the control constant C1-16 (SM_{ADJ}). Since C1-16 (SM_{ADJ}) is only for adjusting the speedometer, the actual speed is not influenced by it. The forward and reverse run speed accuracy is ±3% max. of the rated speed. 	Item	Specifications	Name	Voltmeter	Activation	Moving coil type	Rating	10 V full-scale	Internal Resistance	10 kΩ	Class	2.5 class or above
Item	Specifications														
Name	Voltmeter														
Activation	Moving coil type														
Rating	10 V full-scale														
Internal Resistance	10 kΩ														
Class	2.5 class or above														
Load Meter Signal LM	1CN or Screw Terminal No.2	50	<ul style="list-style-type: none"> The load meter indicates the ratio of the actual load to the rated output of the motor. Select a voltmeter conforming to the same specifications as the speedometer. Load meter signal can be adjusted with the control constants C1-17 (LM_{ADJ}) and C1-18 (LM_{FS}) 												

4.9 DIGITAL OPERATOR FUNCTIONS

The VS-626VM3 supports the multi-functional display operator, and enables the following:

① Display of control signal status

Status of control signals of individual parts is displayed to monitor the status of operation. For the display items, see Table 4.2.

② Display and setup of control constants

Control constants must be set up for normal operation according to the specifications. Tables 13.4 to 13.6 list the control constants.

③ Display of activated protective functions

Protective functions activated when an error occurs during operation are displayed. Table 4.3 lists the protective functions. Nothing is displayed when operation is normal.

④ Operation by the digital operator

Stand-alone operation without sequence input signals and speed reference is possible using the digital operator. For details of the operation, see Par. 8.1, "Stand-alone Operation by Speed Control with Digital Operator."

Fig. 4.27 shows the display unit and manipulation keys of the digital operator (JVOP-100).

Fig. 4.28 shows the tree of display items.

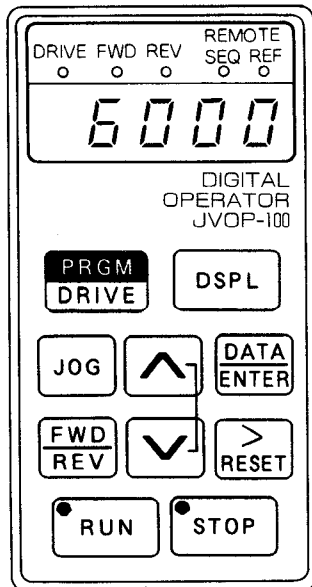

Key	Function
	<ul style="list-style-type: none"> Emergency stop key for the digital operator. No operation in other modes of operation.
	<ul style="list-style-type: none"> When an item is displayed: Changes the display item. When data are displayed: Changes to item display.
	<ul style="list-style-type: none"> When an item is displayed: Changes to data display. When data are displayed: Writes the data to NVRAM.
	<ul style="list-style-type: none"> Selects values and item numbers to be set up. Updates the error occurrence sequence.
	<ul style="list-style-type: none"> Resets an error. (Effective only when error display is on.) Shift of selected column. (blinking at a currently selected column.)
	<ul style="list-style-type: none"> Operation reference
	<ul style="list-style-type: none"> Stop reference
	<ul style="list-style-type: none"> Selects a rotation direction
	<ul style="list-style-type: none"> Jogging operation

Fig. 4.27 Display Unit and Keys of the Operator

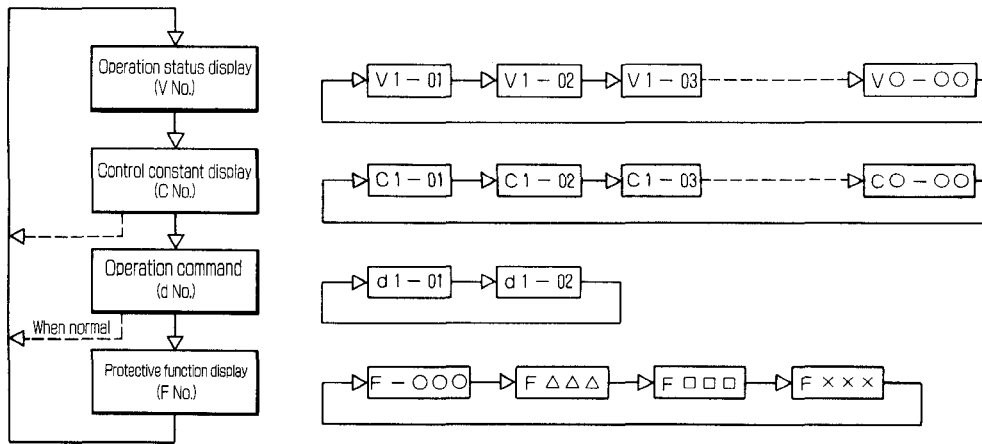

Fig. 4.28 Tree of Display

上正科技有限公司
 購買、維修 此手冊零組件
 電話： 037-466333
 Email: service@repairtw.com
 Line id: @zzzz
 www.repairtw.com

5. OPTIONAL EQUIPMENT AND SPECIFICATIONS

A variety of options are prepared for VS-626VM3 Drives to meet different requirements. Choose the best option for your purpose from the following:

5.1 WINDING SELECTION MAGNETIC CONTACTOR

This is a compact magnetic contactor developed for motor winding selection control and motor switch operation. The inverter controls the switching of the contactor directly. Mechanical life of the contactor is five million operations.

When the magnetic contactor is used for motor switching, internal short-circuit bar should be removed. Contact your YASKAWA representative.

5.1.1 Ratings and Specifications

Table 5.1 Standard Specifications

Type	HV-75AP3	HV-150AP3
Contact Arrangement	Main Contact: 3NO3NC, Auxiliary contact: 1NO	
Rated Isolation Voltage	600 V	
Rated Energizing Current	75 A (Continuous) 87 A (30-min 33%ED)*	150 A (Continuous), 175 A (30-min 33%ED)*
Max. Breaking Current	200 A	400 A
Max. Operation Frequency (Switching Duty)	600 times/hour	
Mechanical Life	5,000,000 times	
Ratings of Applicable Magnetic Coils	200 V 50/60 Hz, 220 V 50/60 Hz, 230 V 60 Hz	
Approx Mass	2.5 kg	5.0 kg
Ambient Temperature	-10 to +55°C (14 to 131°F)	
Humidity	10 to 95% RH (non-condensing)	

* : After 30 minutes of energizing, power must be turned OFF for 1 hour or longer.

5.1.2 Dimensions in mm (inches)

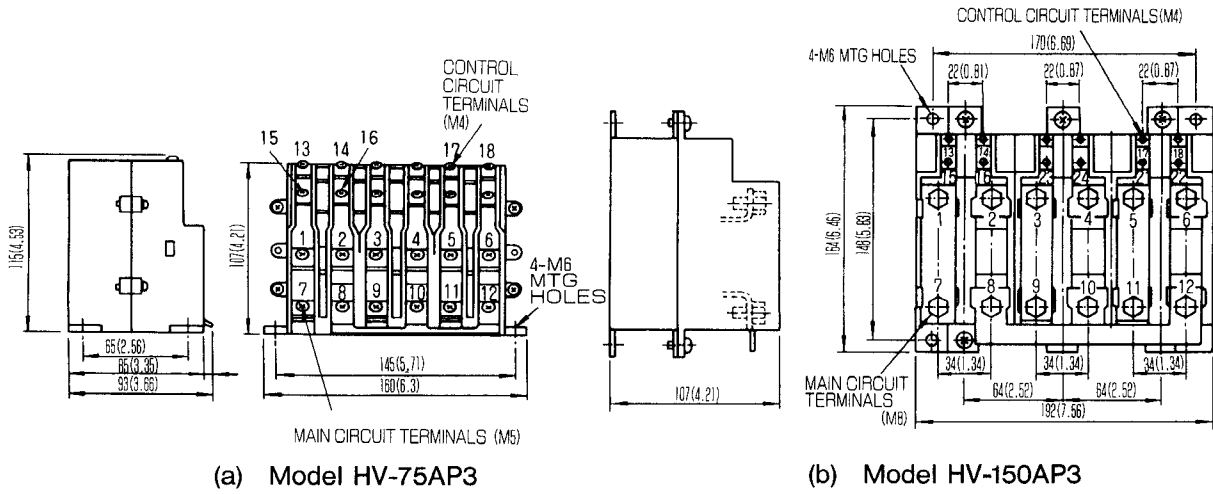

Fig. 5.1 Dimensions

5.1.3 Status of Operation

上正科技有限公司
購買、維修、此手冊零組件
電話: 037-650333
Email: service@repairtw.com
Line id: @zzzz

Selective Signal ⑬-⑭	Main Contacts						Auxiliary Contacts ⑮-⑯
	①-②	③-④	⑤-⑥	⑦-⑧	⑨-⑩	⑪-⑫	
+ 24 V	OPEN			CLOSE			OPEN
0 V	CLOSE			OPEN			CLOSE

www.repairtw.com

5.2 MAGNETIC SENSOR ORIENTATION CARD

A simple positioning system, consisting of magneto, magnetic sensor and orientation card allows spindle positioning for tool change operations.

After stopping the spindle at the center of the magneto, the spindle may be indexed, using the spindle-motor encoder as position feedback.

5.2.1 Orientation Specifications

Table 5.2 Standard Specifications

Item	Explanations
Position Detecting Method	Position displacement is detected from flux changes using a magneto and a magnetic sensor.
Stop Position	The rotor stops at a position where the centers of the magneto and the magnetic sensor head face each other. Adjustment is available within $\pm 2^\circ$ by the adjustment resistor.
Stop Position Repetition Error*	$\pm 0.2^\circ$ or less
Resisting Torque	Continuous rated torque / $\pm 0.1^\circ$ displacement †
Orientation Card	Code No.: ETC621020.1 (applicable to inverter units 27P5 or smaller capacity) Code No.: ETC621020.2 (applicable to inverter units 2011 or greater capacity)
Magnet	Type: MG-1378BS, MG-1444S (MG1378BS is the standard.)
Magnetic Sensor	Type: FS-1378C, FS-200A (FS-1378C is the standard.)

* When the magneto is mounted on the circumference of a spindle of 120mm diameter. Mechanical error and interference by external magnetic field is not considered.

† Continuous rated torque may not be obtained depending on the gain setting.

電話 Table 5.37 Magnetic Sensor

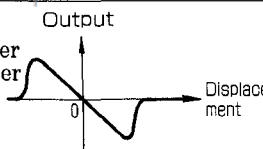
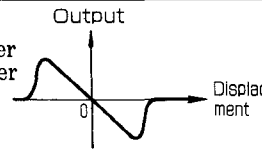
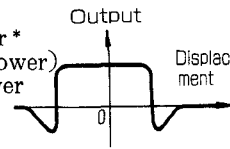
Item	Explanations	
	Type FS-1378C	Type FS-200A
Power Voltage	15 VDC $\pm 5\%$	12 VDC $\pm 10\%$
Current Consumption	100mA or less	50mA or less
Position Signal (for control) Level Offset Output impedance	$\pm 4\text{V}$ or greater $\pm 0.2\text{V}$ or lower $1.5\text{k}\Omega$ 	$\pm 8\text{V}$ or greater $\pm 0.2\text{V}$ or lower $1.5\text{k}\Omega$ 
Position Signal (for monitoring) Range Offset	30° or greater* $(+2.4\text{V}$ or lower) $\pm 0.5\text{V}$ or lower 	
Operating Temperature	-10° to $+50^\circ\text{C}$	
Output Terminals	Round connector (manufactured by Tajimi Radio Electric Appliances) A: Position signal + B: SG C: +15V D: Position signal - E: Range signal - F: Range signal + †	6mm dia. 4-core cabtyre cable, 5m long <Wiring> Red: +12V Black: SG Green: Output + White: Output -
Manufacturer	Makome Laboratory	

* When the magneto is mounted on the circumference of a spindle of 120mm diameter.

† The range signals output from terminals E and F can be used for monitoring.

Table 5.4 Magneto Specifications

Item	Explanation	
	Type MG-1348BS	Type MG-1444S
Detection Range mm (inches)	±15	±7
Allowable Speed (r/min.) (Mounted on the circumference of 200mm diameter.)	6700	10,000
Mass (g)	33	15
Manufacturer	Makome Laboratory	

5.2.2 Dimensions in mm (in inches)

(1) Orientation card (ETC621020.1)

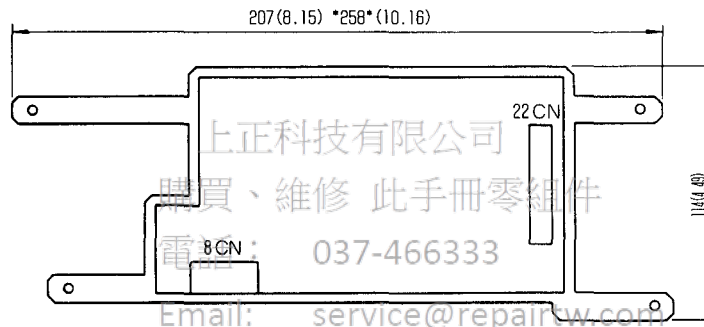

*Dimensions of ETC621020.2

Note: Orientation card is mounted on the main unit at the factory.

www.repairtw.com

Fig. 5.2 Dimensions of Orientation Card in mm (inches)

(2) Magneto

(a) Type MG-1378BS

(b) Type MG-1444S

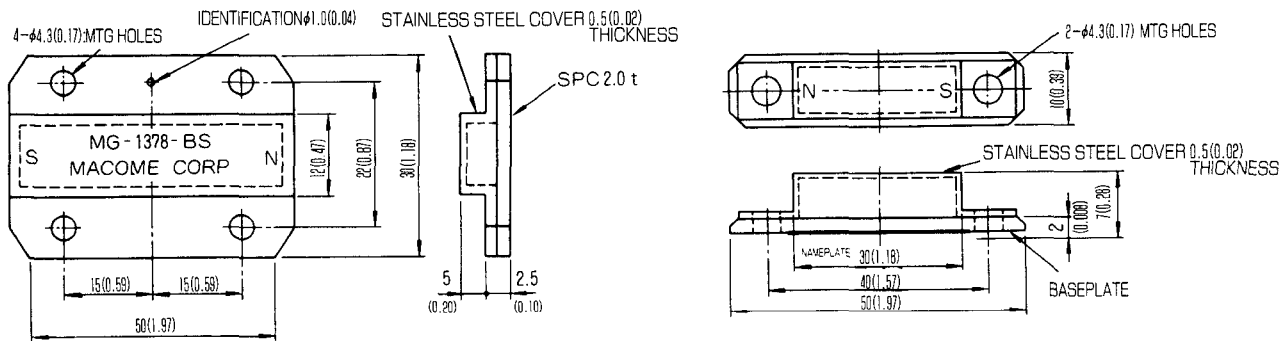
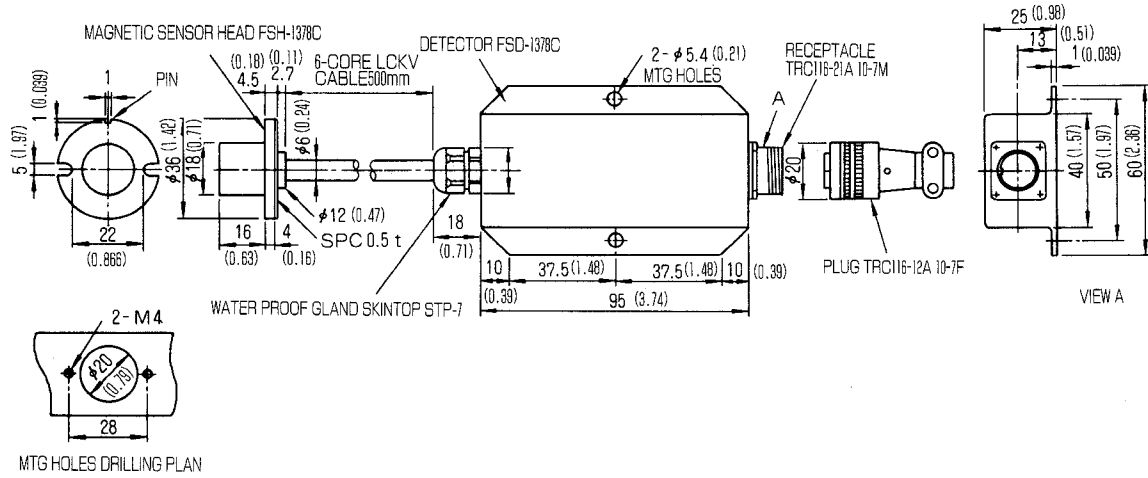

Fig. 5.3 Dimensions of Magneto in mm (inches)

(3) Magnetic Sensor
 (a) Type FS-1378C

MAGNETO MOTION DIRECTION



(b) Type FS-200A

上正科技有限公司
 購買、維修 此手冊零組件
 電話： 037-466333

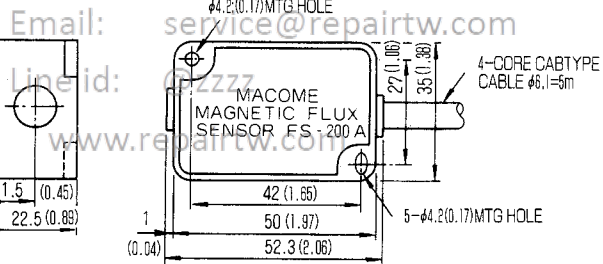
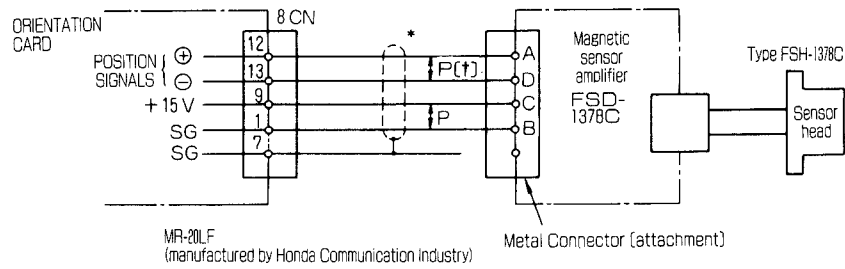

Fig. 5.4 Dimensions of Magnetic Sensor in mm (inches)

5.2.3 Connection

(1) Magnetic Sensor Signal



Note: Consult the company on the other combinations of gear ratio.

* Use 0.3mm twisted pair 3P vinyl cable (copper-braided and shielded). Wiring extension must be 20 meters or shorter.

† \overline{IP} indicates a twisted pair cable.

(a) Type FS-1378C

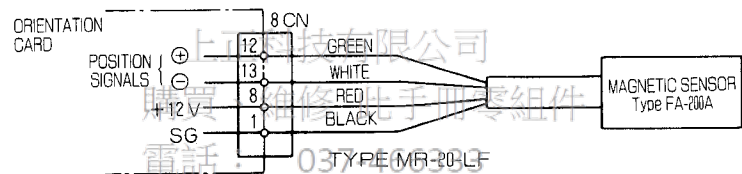

(b) Type FS-200A

Fig. 5.5 Connection of Magnetic Sensor
www.repairtw.com

(2) Stop position reference

Position reference for optional indexes with actual position feedback from the spindle-motor encoder.

Note: For terminal layout of connectors, see Fig. 4.12 (b).

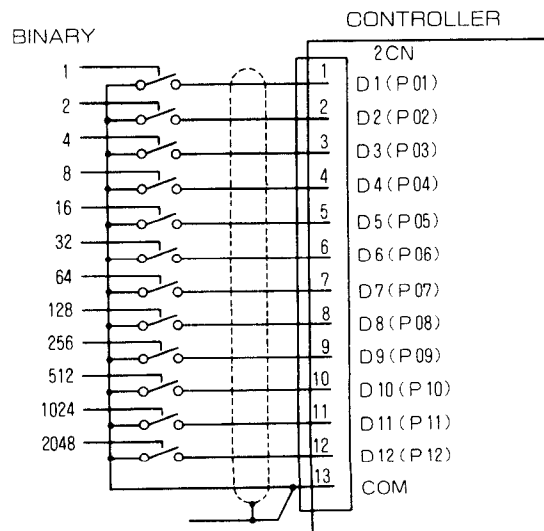

Fig. 5.6 Interconnection Diagram

5.2.4 Control Signal Connector Terminal Layout

20	19	18	17	16	15	14
—	—	—	—	—	—	—
	13	12	11	10	9	8
	SIG -	SIG +	—	—	+15	+12
7	6	5	4	3	2	1
0 V (SS)	—	—	—	0 V	0 V	0 V

PBC Side ; MR-20RMAG
Cable Side ; MR-20LF(G)
or MR-20LWF(G)

- Notes: 1. The layout of pins is for the case where the connectors on the circuit board are viewed from the mating connector.
2. In the diagram, the symbol \square represents an input signal and \square an output signal

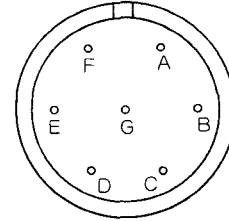

Magnetic Sensor Side ; TRC116-21A10-7M
Cable Side ; TRC116-12A10-7F

- Notes: 1. The layout of pins is for the case where the connectors on the sensor are viewed from the mating connector.
2. The connector to the cable belongs to the magnetic sensor.
3. Connectors are made by Tajimi Radio Electric Co. Ltd.

(a) 8CN (Orientation Card Side)

(b) Magnetic Sensor Side (FS-1378C)

Fig. 5.7 Connection Pin Location

5.2.5 Installing Magneto and Magnetic Sensor

The magneto is installed on the load axis, and the magnetic sensor is installed on a stationary part. Their relative position must be such that when the load axis is in the intended stop position, the magneto and the magnetic sensor are aligned center-to-center.

Fig. 5.8 shows the installing method, and Table 5.5 gives the required mounting accuracy.

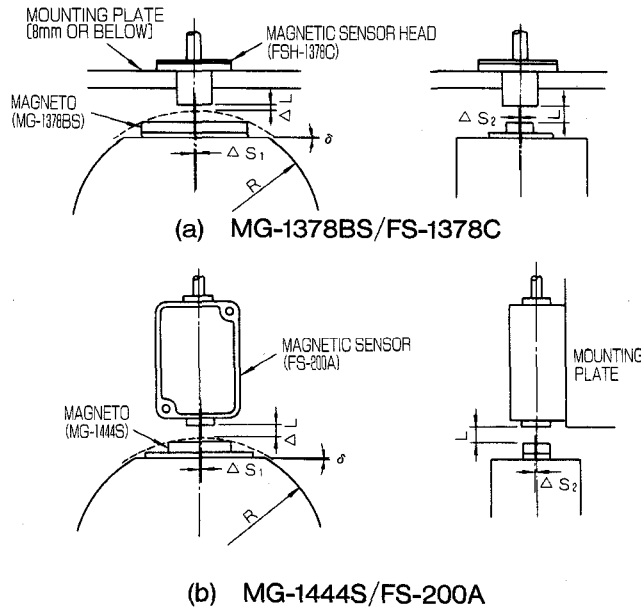

Fig. 5.8 Installing Magneto and Magnetic Sensor (1)

Code	Dimensions	MG-1378BS / FSH-1378C	MG-1444S / FS-200A
R	Radius of spindle member *	60 to 70 mm (2.36 to 2.76 inches)	60 to 70 mm (2.36 to 2.76 inches)
L	Gap (center of magneto to magnetic sensor) [†]	6 mm (0.24 inches) [6 to 8 mm (0.24 to 0.31 inches)]	5 mm (0.197 inches) [3 to 7 mm (0.12 to 0.28 inches)]
ΔL	Gap (end of magneto to magnetic sensor) [†]	1 to 2mm (0.04 to 0.08 inches)	1 to 2mm (0.04 to 0.08 inches)
$\Delta S1, \Delta S2$	Center position error of magneto and magnetic sensor [‡]	0.5 mm max (0.02 inches)	0.5 mm max (0.02 inches)
δ	Angular displacement error from datum plane [‡]	0.2° max	0.2° max

* In determining the diameter of the spindle member for installing the magneto take the permissible maximum centrifugal force of the magneto into consideration.

[†] The L value is a recommended value. Adjust the gap so as to satisfy the ΔL requirement.

[‡] In aligning magneto to the mechanical center line of the system such as the spindle nose key of a machining center, observe the specified mounting accuracy standards for the center position and angular position of the magneto.

Fig. 5.8 Installing Magneto and Magnetic Sensor (2)

5.2.6 Notes on Mounting

- (1) The magnet's flux provides feedback for the position loop. Mount the magneto on the spindle (such as the spindle of a milling machine).
 - ★ - If there is any transmission such as belt or gear between the axis with magneto and the spindle, stop position of the spindle may vary because of belt slippage or gear backlash.
- (2) The magneto has to be mounted on non-magnetic materials. Avoid adhesion of iron filings on the magneto.
 - ★ - If there is any magnetic substance near the magneto, the magnetic field is distorted and position detection impaired, and the rotor may fail to stop at the proper position.
- (3) Be careful not to damage the magneto and the magnetic sensor when mounting.
 - ★ - The magneto rotates at high speeds. Slight damage may lead to an unpredictable malfunction. The magnetic sensor is precision equipment. If force is applied to cause of internal distortion, detection precision may be deteriorated.
- (4) Remove magnetic field generating equipment such as solenoids and magnets from around the magneto and the magnetic sensor.
 - ★ - If there is any magnetic field generating equipment near the magneto, the magnetic field may be distorted and proper position detection cannot be executed, and the rotor may fail to stop at the proper position.

- (5) Avoid oil or water splashes on the magnetic sensor amplifier and the connecting cables. If the sensor head is frequently exposed to oil or water splashes, use sealing materials to avoid oil and water entry into the bushing as shown in Fig. 5.9.
- ★ - If water or used oil enters into the magnetic sensor or connecting cables, insulation deteriorates over time and the detection signals may be distorted, causing unacceptable control variations.

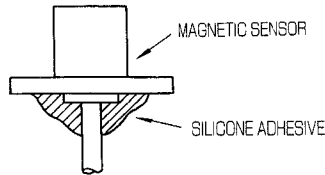
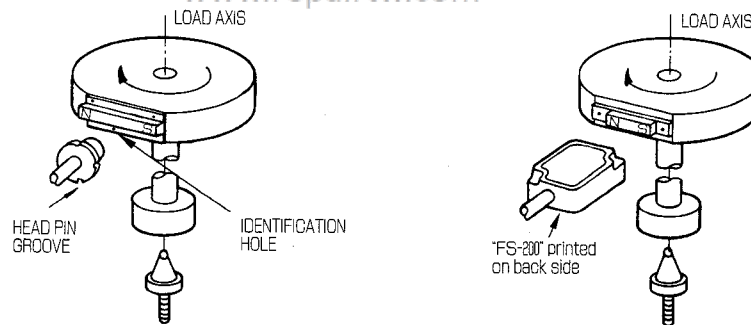

Fig. 5.9 Prevention of Liquid Entry into the Magnetic Sensor Bushing

- (6) Cable length between the magnetic sensor amplifier and the orientation card must be 20 meters or shorter.
- ★ - Only a slight difference in voltage causes error detection signals of the magnetic sensor. Longer cables undergo more interferences by error voltage and noise voltage, leading to position errors.
- (7) The magneto and the magnetic sensor must be mounted with the poles in proper position as shown in Fig. 5.10. If the polarity is reversed, however, control is possible by reversing the signals in the orientation card.



(a) Type MG-1378BS/FS-1378C

(b) Type MG-1444S/FS-200

Fig. 5.10 Magneto and Magnetic Sensor Mounting Direction

5.2.7 Stop Position Reference Input Signal

The stop position reference input signal circuit of magnetic sensor type orientation control is same as that of the sequence signal in Par. 4.8.1.

Table 5.5 Input Signal

Signal Name	Connector No.	Pin No.	Signal Level at Operation	Description																																																						
Stop Position Reference Signal	2CN	1	L (Open)	<ul style="list-style-type: none"> This is a stop position reference when arbitrary-position stop control (incremental operation) by magnetic sensor orientation D1 to D12 become the stop position reference by setting the bit 7 of select signal C1-36 (SEL1) to "1". See Table 4.11 for bit selection. This a stop position reference which is input from outside with the load axis home position assumed as 0. For position reference, either a 12-bit binary or 3-digit BCD may be selected. <table border="1" style="width: 100%; border-collapse: collapse;"> <tr> <td rowspan="2" style="writing-mode: vertical-rl; text-orientation: mixed;">Incremental</td> <td>Binary</td> <td>Code 1-bit Data 11-bit</td> <td>-179.9° to 179.9° (-000_H to +7FF_H)</td> </tr> <tr> <td>BCD</td> <td>Code 1-bit Data 3-digit (11-bit)</td> <td>-θ to +θ (-799_D to +799_D)</td> </tr> </table>	Incremental	Binary	Code 1-bit Data 11-bit	-179.9° to 179.9° (-000 _H to +7FF _H)	BCD	Code 1-bit Data 3-digit (11-bit)	-θ to +θ (-799 _D to +799 _D)																																															
		Incremental				Binary	Code 1-bit Data 11-bit	-179.9° to 179.9° (-000 _H to +7FF _H)																																																		
BCD	Code 1-bit Data 3-digit (11-bit)		-θ to +θ (-799 _D to +799 _D)																																																							
		12		<ul style="list-style-type: none"> Sign bit is - (minus) if in the ON state and + (plus) if in the OFF state. θ can be obtained as a product of the data of 3-digit BCD and C3-12 (P_{BCD}), the BCD stop position reference resolution. (θ < 360°) The relation between reference signals and number of pulses are shown in the following table. <table border="1" style="width: 100%; border-collapse: collapse;"> <thead> <tr> <th rowspan="2">Bit</th> <th rowspan="2">Pin No.</th> <th>Binary</th> <th>BCD</th> </tr> <tr> <th>With Code</th> <th>With Code</th> </tr> </thead> <tbody> <tr><td>1</td><td>1</td><td>1</td><td>1</td></tr> <tr><td>2</td><td>2</td><td>2</td><td>2</td></tr> <tr><td>3</td><td>3</td><td>4</td><td>4</td></tr> <tr><td>4</td><td>4</td><td>8</td><td>8</td></tr> <tr><td>5</td><td>5</td><td>16</td><td>10</td></tr> <tr><td>6</td><td>6</td><td>32</td><td>20</td></tr> <tr><td>7</td><td>7</td><td>64</td><td>40</td></tr> <tr><td>8</td><td>8</td><td>128</td><td>80</td></tr> <tr><td>9</td><td>9</td><td>256</td><td>100</td></tr> <tr><td>10</td><td>18</td><td>512</td><td>200</td></tr> <tr><td>11</td><td>19</td><td>1024</td><td>400</td></tr> <tr><td>12</td><td>29</td><td>Code</td><td>Code</td></tr> </tbody> </table> <ul style="list-style-type: none"> In the case of binary-coded decimal notation, the content of the signal varies with the polarity of the code. <ul style="list-style-type: none"> <If it is ON> Sum of number of pulses of the bits that are input. 0 0 1 0 1 0 0 1 0 0 1 ⋮ ⋮ 256+64 + 8 + 1=329 <If it is OFF> Complement of the number of pulses of the bits that are input. - (256+64+341) = -329 Motions exceeding 180° are not available in the binary notation. However, in the case of BCD reference, depending on the setting of BCD stop position reference C3-12 (P_{BCD}) reference exceeding 180° (up to ±360° maximum) are available. 	Bit	Pin No.	Binary	BCD	With Code	With Code	1	1	1	1	2	2	2	2	3	3	4	4	4	4	8	8	5	5	16	10	6	6	32	20	7	7	64	40	8	8	128	80	9	9	256	100	10	18	512	200	11	19	1024	400	12	29	Code	Code
Bit	Pin No.	Binary	BCD																																																							
		With Code	With Code																																																							
1	1	1	1																																																							
2	2	2	2																																																							
3	3	4	4																																																							
4	4	8	8																																																							
5	5	16	10																																																							
6	6	32	20																																																							
7	7	64	40																																																							
8	8	128	80																																																							
9	9	256	100																																																							
10	18	512	200																																																							
11	19	1024	400																																																							
12	29	Code	Code																																																							

5.3 ENCODER ORIENTATION CARD

Position of the rotor is determined by dividing one rotation of the rotor into 4096 (at a resolution of 0.088°) using the signal from the encoder of the load axis (such as the spindle of the milling machine) and the encoder orientation card to generate stop angle reference coded in 12-bit binaries or 3-digit binary-coded decimals (BCDs).

5.3.1 Orientation Specifications

Table 5.6 Standard Specifications

Item	Functions
Positioning Mode	Absolute/incremental programming
Position Detection Mode	Spindle angle detection by A-,B- and C-phase pulses of encoder *
Stop Position *	Position corresponding to the external command or internal setting based on load axis home position† Angle resolution: 0.088° (= 360°/4096)
Accuracy of Stop Position Repeating *	±0.2° or below
Reaction Torque *	Continuous rated torque/±0.1° displacement‡
Orientation Card	Code No. ETC621030.1 (for inverter unit capacity 27P5 max.) Code No. ETC621030.2 (for inverter unit capacity 2011 min.)
Load Axis Encoder	Model PC-1024ZLH (Spindle-mounted type) UTMSI-10AAB (Built-in motor type)

* It removes the mechanical errors including backlash and eccentricity.

† Load axis home position can be obtained by setting the number of offset pulses from the rising of C-phase pulse of encoder during clockwise rotation.

‡ As a result of setting a gain, continuous rated torque may not be output. And, sudden load variation will increase displacement.

Table 5.7 Encoder Specifications

Item	Description		
Type	PC-1024ZLH-4K-68	PC-1024ZLH-6K-68	UTMSI-10AAB†
Max. Speed* (r/ min)	4000	6000	10000
Power Supply	+5VDC ± 5 %		—
Dissipated Current	Max 350 mA.		—
No. of Pulses	A-,B-phase 1024 pulses/ rev. C-phase 1 pulses/ rev.		
Output	Each phase is of parallel output by line driver. SN75113 SN75158		
Max. Response Frequency	A-,B-phase 80 kHz C-phase 70 kHz (4690 r/ min)	A-,B-phase 120 kHz C-phase 117 kHz (7000 r/ min)	A-,B-phase 188 kHz C-phase 183 kHz (11000 r/ min)
Accumulated Pitch Error	Within 33 % of A-,B-phase signal frequency		Within 50 % of A-,B-phase signal frequency
Pitch Error	Within 12.5 % of A-,B-phase signal frequency		
Input Shaft Inertia	Max. 1×10^{-3} kgf · cm · s ²		—
Input Shaft Torque	Max. 1 kgf · cm		—
Input Shaft Allowable Load (Thrust) (Radial)	At standstill Max. 10 kg Max. 20 kg	At running Max. 4 kg Max. 6 kg	—
Construction	Dustproof, dripproof (With oil seal)		Motor flange mounting
Output Connector (Main Unit Side) (Cable Side) (Manufacturer)	MS3102A20-29P MS3106A20-29S JAPAN AVIATION ELECTRONICS INDUSTRY,LTD.		MLR-12 MLP-12 (Nippon Pressure Terminal Sales Co., Ltd.)
Mass	1.5 kg		0.33 kg (Encoder disk)
Ambient Temperature	0 to +60°C		0 to +40°C
Humidity	10 to 95 % RH (Non-condensing)		95 % RH or less (Non-condensing)

* Shows upper limit speed in practical use.

† Type UTMSI-10AAB is an encoder housed in the motor. Ambient temperature and humidity are the same as motor specifications.

5.3.3 Connections

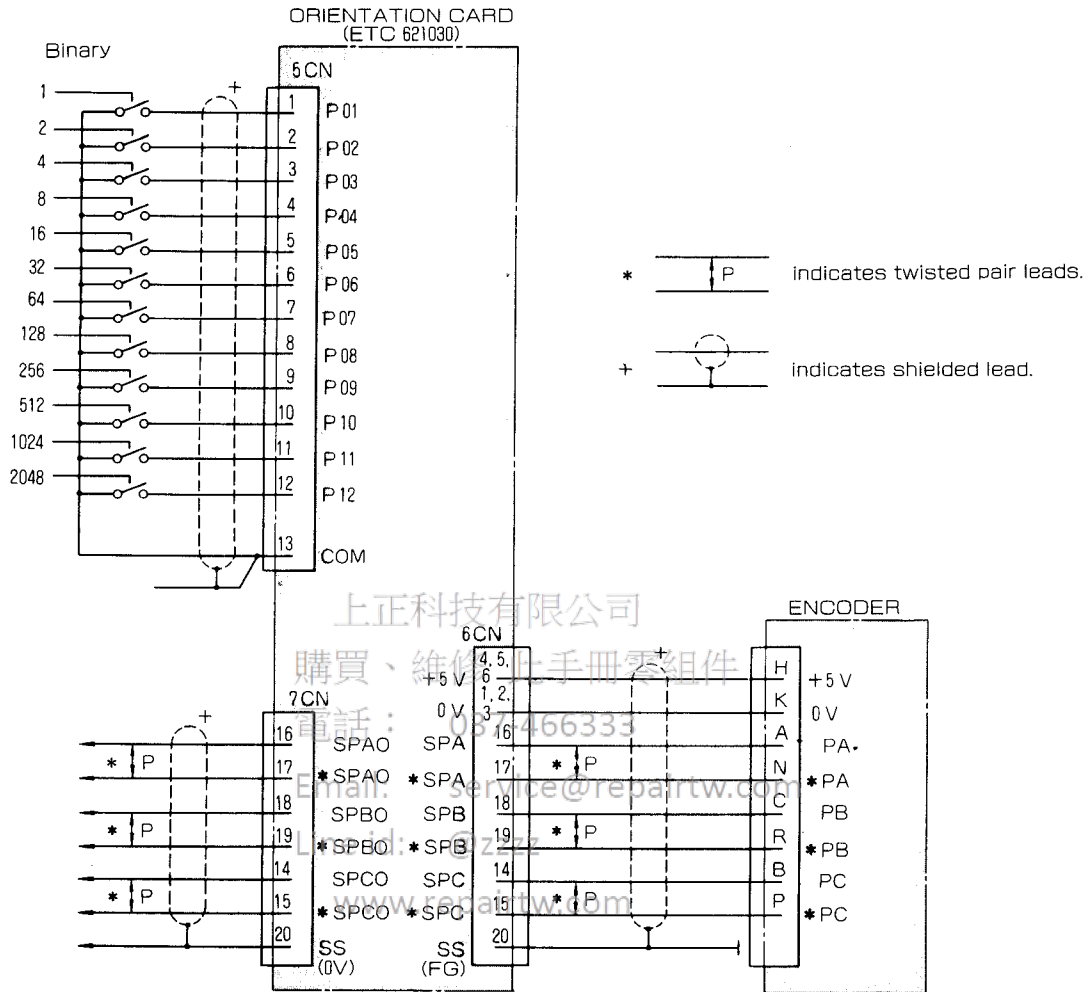

Fig. 5.13 Interconnections

5.3.4 Control Signal Connectors Terminal Assignment

14	15	16	17	18	19	20
—	—	—	—	—	—	SS (0V)
	8	9	10	11	12	13
	P08	P09	P10	P11	P12	COM
1	2	3	4	5	6	7
P01	P02	P03	P04	P05	P06	P07

PC Board Connector: MR-20RFAG

Cable Side Connector: MR-20LM (G)

(a) 5CN (Stop position reference input)

20	19	18	17	16	15	14
SS (0V)	*SPB	SPB	*SPA	SPA	*SPC	SPC
	13	12	11	10	9	8
	*CPB	CPB	*CPA	—	CPA	*CPC
7	6	5	4	3	2	1
CPC	+5V	+5V	+5V	0V	0V	0V

PC Board Connector: MR-20RMAG

Cable Side Connector: MR-20LF (G)

(b) 6CN (Load axis encoder signal input)

14	15	16	17	18	19	20
SPCO	*SPCO	SPAO	*SPAOS	SPBO	*SPBO	SS (0V)
	8	9	10	11	12	13
	—	—	—	—	—	—
1	2	3	4	5	6	7
—	—	—	—	—	—	—

PC Board Connector: MR-20RFAG

Cable Side Connector: MR-20LM (G)

(c) 7CN (Load axis encoder signal output)

- Notes: 1. The layout of pins is for the case where the connectors on the PC board are viewed from the fitted part.
 2. In the diagram, the symbol represents an input signal and an output signal.
 3. *Shows the reverse signals.

Fig. 5.14 Connector Pin Location

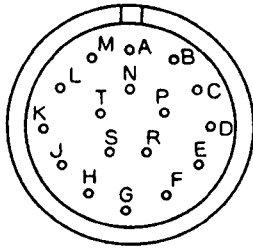

Main unit side MS3102A20-29P
 Cable side MS3108A20-29S (Angle plug)
 MS3106A20-29S (Straight plug)
 MS3057-12A (Cable clamp)

Made by Japan Aviation Electronics Industry, Ltd.

A	B	C	D	E	F	G	H	I
PA	PC	PB	-	FG	-	-	+5V	-
K	L	M	N	P	R	S	T	
0 V	-	-	* PA	* PC	* PB	-	-	

* : Reverse signals

Fig. 5.15 Connector Pin Arrangement

5.3.5 Notes on Installing and Wiring of Encoder

Table 5.8 Details of Specifications of Applicable Cables

- Limit the length of signal cable between orientation card and encoder to less than 20 meters.
- We have available the signal cable described in the specification shown in Table 5.8. You can purchase this optional item in the standard lengths according to your requirement.
- During installation, keep the power cable and signal cable apart from each other to prevent interference from electrical noise.
- During normal rotation of spindle, if the encoder rotates clockwise as viewed from the spindle, interchange A - and B - phases as shown in Fig. 5.16.

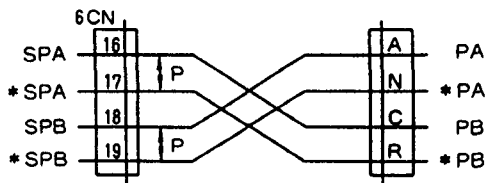

Fig. 5.16 Signal Lead Change

Connection	Soldered Type	Caulking Type																																					
YASKAWA Drawing No.	DP 8409123	DE 8400093																																					
Manufacturer	Fujikura Cable Co.																																						
General Specifications	Double KQVV-SW AWG22×3C AWG26×6P	KQVV-SB AWG26×10P																																					
	For Soldered Type	For Caulking Type																																					
Internal Composition and Lead Color Standard																																							
	<table border="1"> <tr><td>A₁</td><td>Red</td></tr> <tr><td>A₂</td><td>Black</td></tr> <tr><td>A₃</td><td>Green yellow</td></tr> <tr><td>B₁</td><td>Blue-White/ blue</td></tr> <tr><td>B₂</td><td>Yellow-White/ yellow-</td></tr> <tr><td>B₃</td><td>Green-White/ green</td></tr> <tr><td>B₄</td><td>Orange-White/ orange</td></tr> <tr><td>B₅</td><td>Purple-White/ purple</td></tr> <tr><td>B₆</td><td>Grey-White/ grey</td></tr> </table>	A ₁	Red	A ₂	Black	A ₃	Green yellow	B ₁	Blue-White/ blue	B ₂	Yellow-White/ yellow-	B ₃	Green-White/ green	B ₄	Orange-White/ orange	B ₅	Purple-White/ purple	B ₆	Grey-White/ grey	<table border="1"> <tr><td>1</td><td>Blue-White-</td></tr> <tr><td>2</td><td>Yellow-White-</td></tr> <tr><td>3</td><td>Green-White-</td></tr> <tr><td>4</td><td>Red-White-</td></tr> <tr><td>5</td><td>Purple-White-</td></tr> <tr><td>6</td><td>Blue-Brown-</td></tr> <tr><td>7</td><td>Yellow-Brown-</td></tr> <tr><td>8</td><td>Green-Brown-</td></tr> <tr><td>9</td><td>Red-Brown-</td></tr> <tr><td>10</td><td>Purple-Brown-</td></tr> </table>	1	Blue-White-	2	Yellow-White-	3	Green-White-	4	Red-White-	5	Purple-White-	6	Blue-Brown-	7	Yellow-Brown-	8	Green-Brown-	9	Red-Brown-	10
A ₁	Red																																						
A ₂	Black																																						
A ₃	Green yellow																																						
B ₁	Blue-White/ blue																																						
B ₂	Yellow-White/ yellow-																																						
B ₃	Green-White/ green																																						
B ₄	Orange-White/ orange																																						
B ₅	Purple-White/ purple																																						
B ₆	Grey-White/ grey																																						
1	Blue-White-																																						
2	Yellow-White-																																						
3	Green-White-																																						
4	Red-White-																																						
5	Purple-White-																																						
6	Blue-Brown-																																						
7	Yellow-Brown-																																						
8	Green-Brown-																																						
9	Red-Brown-																																						
10	Purple-Brown-																																						
YASKAWA Standard Specifications	Standard length: 5m, 10m, 20m. Terminal ends are not provided (with connectors).																																						

5.3.6 Stop Position Reference Input Signal

The input signal circuit of the encoder orientation card is the same as the circuit explained in Par. 4.8.1, "Sequence Input Signals."

Table 5.9 Input Signal

Signal Name	Connector No.	Pin No.	On Level	Description																																																																				
Stop Position Reference	5CN	1 to 12	L (Close)	<ul style="list-style-type: none"> This is a stop position reference which is input from outside with the load axis home position assumed as 0 (zero). For position reference, either a 12-bit binary or 3-digit BCD may be selected. 																																																																				
				<table border="1"> <tr> <td rowspan="2">Absolute</td> <td>Binary</td> <td>Data 12-bit</td> <td>0° to 359.9° (000_H to FFF_H)</td> </tr> <tr> <td>BCD</td> <td>Code 1-bit Data 3-digit (11-bit)</td> <td>-θ to +θ (-799_D to +799_D)</td> </tr> <tr> <td rowspan="2">Incremental</td> <td>Binary</td> <td>Code 1-bit Data 11-bit</td> <td>-180° to 179.9° (-000_H to +7FF_H)</td> </tr> <tr> <td>BCD</td> <td>Code 1-bit Data 3-digit (11-bit)</td> <td>-θ to +θ (-799_D to +799_D)</td> </tr> </table>	Absolute	Binary	Data 12-bit	0° to 359.9° (000 _H to FFF _H)	BCD	Code 1-bit Data 3-digit (11-bit)	-θ to +θ (-799 _D to +799 _D)	Incremental	Binary	Code 1-bit Data 11-bit	-180° to 179.9° (-000 _H to +7FF _H)	BCD	Code 1-bit Data 3-digit (11-bit)	-θ to +θ (-799 _D to +799 _D)																																																						
Absolute	Binary	Data 12-bit	0° to 359.9° (000 _H to FFF _H)																																																																					
	BCD	Code 1-bit Data 3-digit (11-bit)	-θ to +θ (-799 _D to +799 _D)																																																																					
Incremental	Binary	Code 1-bit Data 11-bit	-180° to 179.9° (-000 _H to +7FF _H)																																																																					
	BCD	Code 1-bit Data 3-digit (11-bit)	-θ to +θ (-799 _D to +799 _D)																																																																					
				<ul style="list-style-type: none"> Sign bit is - (minus) if in the ON state and + (plus) if in the OFF state. θ can be obtained as a product of the data of 3-digit BCD and C3-12 (P_{BCD}), the BCD stop position reference resolution. (θ < 360°) The relation between reference signals and number of pulses are shown in the following table. 																																																																				
				<table border="1"> <thead> <tr> <th rowspan="2">Bit</th> <th rowspan="2">Pin No.</th> <th colspan="2">Binary</th> <th>BCD</th> </tr> <tr> <th>Without Code</th> <th>With Code</th> <th>With Code</th> </tr> </thead> <tbody> <tr><td>1</td><td>1</td><td>1</td><td>1</td><td>1</td></tr> <tr><td>2</td><td>2</td><td>2</td><td>2</td><td>2</td></tr> <tr><td>3</td><td>3</td><td>4</td><td>4</td><td>4</td></tr> <tr><td>4</td><td>4</td><td>8</td><td>8</td><td>8</td></tr> <tr><td>5</td><td>5</td><td>16</td><td>16</td><td>10</td></tr> <tr><td>6</td><td>6</td><td>32</td><td>32</td><td>20</td></tr> <tr><td>7</td><td>7</td><td>64</td><td>64</td><td>40</td></tr> <tr><td>8</td><td>8</td><td>128</td><td>128</td><td>80</td></tr> <tr><td>9</td><td>9</td><td>256</td><td>256</td><td>100</td></tr> <tr><td>10</td><td>18</td><td>512</td><td>512</td><td>200</td></tr> <tr><td>11</td><td>19</td><td>1024</td><td>1024</td><td>400</td></tr> <tr><td>12</td><td>20</td><td>2048</td><td>Code</td><td>Code</td></tr> </tbody> </table>	Bit	Pin No.	Binary		BCD	Without Code	With Code	With Code	1	1	1	1	1	2	2	2	2	2	3	3	4	4	4	4	4	8	8	8	5	5	16	16	10	6	6	32	32	20	7	7	64	64	40	8	8	128	128	80	9	9	256	256	100	10	18	512	512	200	11	19	1024	1024	400	12	20	2048	Code	Code
Bit	Pin No.	Binary		BCD																																																																				
		Without Code	With Code	With Code																																																																				
1	1	1	1	1																																																																				
2	2	2	2	2																																																																				
3	3	4	4	4																																																																				
4	4	8	8	8																																																																				
5	5	16	16	10																																																																				
6	6	32	32	20																																																																				
7	7	64	64	40																																																																				
8	8	128	128	80																																																																				
9	9	256	256	100																																																																				
10	18	512	512	200																																																																				
11	19	1024	1024	400																																																																				
12	20	2048	Code	Code																																																																				
				<ul style="list-style-type: none"> In the case of binary-coded decimal notation, the content of the signal varies with the polarity of the code. <If it is ON> Sum of number of pulses of the bits that are input. 0 0 1 0 1 0 0 1 0 0 1 ⋮ 256+64 + 8 + 1=329 <If it is OFF> Complement of the sum of the number - (256+64+ 8 + 1)=-329 of pulses of the bits that are input. In the case of incremental, motions exceeding 180° are not available in the binary notation. However, in the case of BCD reference, depending on the setting of BCD stop position reference C2-12 (P_{BCD}) reference exceeding 180° (upto ±360° maximum) are available. 																																																																				

上正科技有限
 購買、維修 此手冊請向
 電話： 037-461533
 Email: service@repairtw.com
 Line id: @zzzz
 www.repairtw.com

5.4 DIGITAL OPERATOR EXTENSION CABLE

The extension cable is used to remove the digital operator from the inverter faceplate and operate and monitor the inverter at a short distance. The cable is also used to mount the digital operator on the control panel. Replace the digital operator by the adapter panel (JVOP-109) as shown in Fig 5.17, and connect the removed digital operator with the adapter panel using the extension cable (1m or 3m) as shown in Fig 5.18.



Fig. 5.17 Adapter Panel

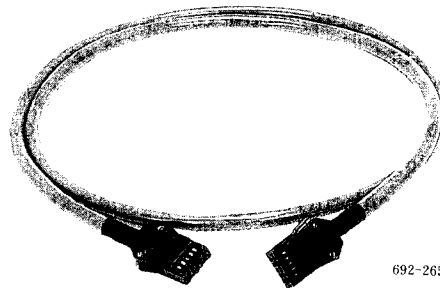

Fig. 5.18 Extension Cable

5.4.1 Adapter Panel and Extension Cable

Table 5.10 Standard Specifications

Name	Type	Code No.	Specifications
Adapter panel*	JVOP-109	73041-09190	Extension cable relay panel Power supply: +5v, 10mA
Adapter panel exclusive extension cable	W3001-01	72616-W3001-01	Cable length: 1m (with a connector case on each ends)†
	W3003-01	72616-W3003-01	Cable length: 3m (with a connector case on each ends)†

* No extension cable is attached to the adapter panel. Purchase the exclusive extension cable, too when purchasing the adapter panel.

† The inverter connector and the digital operator connector are attached on the ends of the extension cable.

- ⚠ - Notes on Connecting the Digital Operator

- (1) Before connecting the digital operator or the digital monitor adapter panel to the inverter, turn OFF the main power of the inverter. And connect them after the CHARGE indicator lamp in the inverter goes OFF. While the CHARGE indicator lamp is ON, internal charge remains and it is dangerous to handle the connectors.
- (2) Before connecting the digital operator, extension cable and the adapter panel, turn OFF the inverter main power and verify that the "POWER" indicator on the adapter panel is OFF.

5.4.2 Replacement with the Extension Cable

- (1) Turn OFF main power and verify the inverter CHARGE indicator lamp goes OFF. (The indicator goes OFF about three minutes after power is turned OFF.)
- (2) Remove the faceplate. Remove the two screws that fasten the digital operator to the PC board frame. Remove the connection cable with the controller. (Store the cable for connecting the digital operator to the inverter again.)
- (3) Mount the adapter panel on the PC board frame with the two screws removed from the digital operator. Plug in the connection cable of the adapter panel to the connector (21CN) on the controller.
- (4) After connecting the adapter panel, mount the faceplate.
- (5) Plug in one connector of the extension cable to the relay connector on the adapter panel. Plug in the other connector to the digital operator.
- (6) Verify that cables are connected securely. Turn ON inverter power and confirm that the "POWER" indicator lamp on the adapter panel and the LEDs on the digital operators light.
- (7) To mount the digital operator on the control panel, refer to the panel cutting pattern shown in Fig. 5.19.
- (8) Weak signal current flows in the extension cable. Separate the cable from the inverter main power line and other power cables.

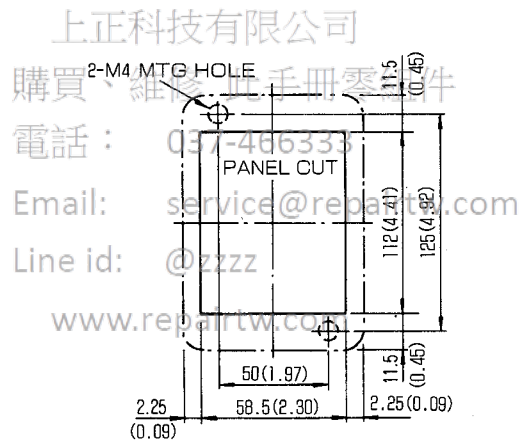

Fig. 5.19 Panel Cutting for Mounting the Digital Operator

5.5 NOISE FILTER

The noise filter reduces radio noise and is used to suppress transmission of high-frequency noise generated by the inverter to the power supply. If the inverter is used where the electric field is weak, an input noise filter effectively suppresses interference to nearby TVs and radios.

5.5.1 Capacities of Noise Filters

Table 5.11 Noise Filter List

(a) For 200V					(b) For 400V				
Max. Motor Output kW	Inverter Capacity kVA	Input Noise Filter			Max. Motor Output kW	Inverter Capacity kVA	Input Noise Filter		
		Type	Rated Current	Code No.			Type	Rated Current	Code No.
3.7	6.9	HF3030A-Z	30	FIL000056	3.7	6.9	HF3015C-Z	15	FIL000063
5.5	10.3	HF3040A-Z	40	FIL000057	5.5	10.3	HF3020C-Z	20	FIL000064
7.5	13.7	HF3050A-Z	50	FIL000058	7.5	13.7	HF3030C-Z	30	FIL000065
11	20.6	HF3080A-Z	80	FIL000059	11	20.6	HF3040C-Z	40	FIL000066
15	27.4	HF3100A-Z	100	FIL000060	15	27.4	HF3050C-Z	50	FIL000067
18.5	34	HF3150A-Z	150	FIL000077	18.5	34	HF3060C-Z	60	FIL000079
22	41				22	41	HF3080C-Z	80	FIL000080
30	55	HF3200A-Z	200	FIL000781	30	54	HF3100C-Z	100	FIL000081
					37	68	HF3150C-Z	150	FIL000082
					45	82			

5.5.2 Example of Connecting Input Noise Filter

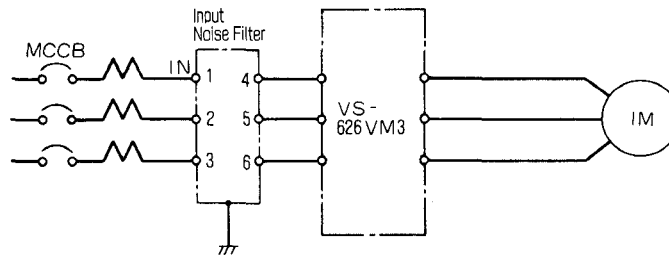
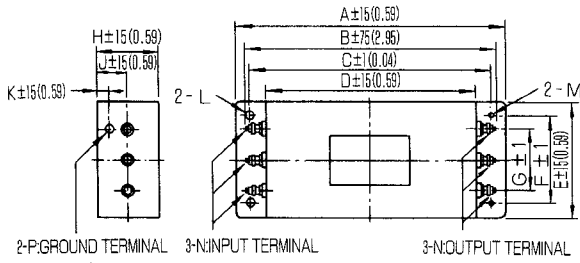
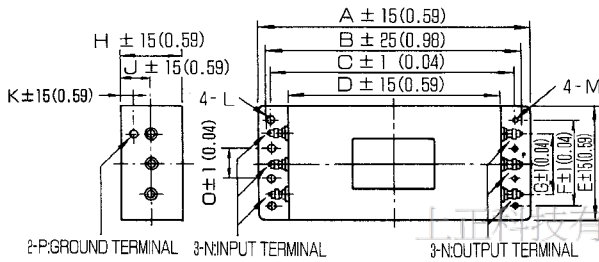

Fig. 5.20 Example of Connecting Input Noise Filter

5.5.3 Dimensions in mm (in inches)



Dimensions 1



Dimensions 2

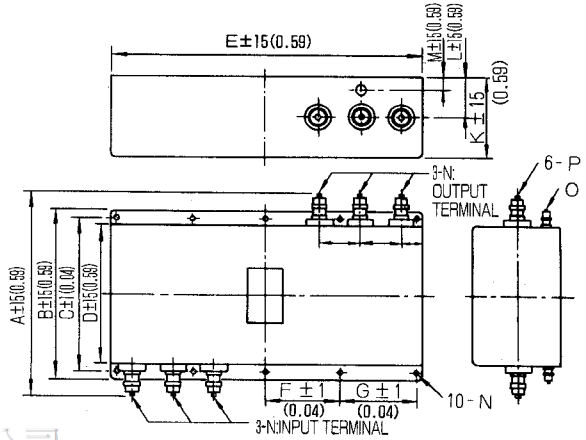

Dimensions 3

士正科技有限公司
 購買、維修 此手冊零組件
 電話： 037-466333
 Email: service@repairtw.com

Type	Dimensions No.	A	B	C	D	E	F	G	H	J	K	L	M	N	P	Q	Approx Mass kg (lb)		
For 200 V	HF3030A-Z	1	274 (10.79)	258 (10.16)	230 (9.06)	2110 (8.27)	110 (4.33)	80 (3.15)	60 (2.36)	70 (2.76)	35 (1.38)	12 (0.47)	R2.75(0.11) 7(0.28)Long	φ5.5 (0.22)	M5	M4	—	2.4 (5.28)	
	HF3040A-Z	2	355 (13.98)	330 (12.99)	320 (12.60)	285 (11.22)	120 (4.72)	90 (3.54)	70 (2.76)	80 (3.15)	40 (1.57)	12 (0.47)	R3.75(0.15) 8(0.31)Long	φ6.5 (0.26)	M5	M4	30 (1.18)	4.8 (10.56)	
	HF3050A-Z		340 (13.39)	320 (12.60)	285 (11.22)	120 (4.72)	90 (3.54)	70 (2.76)	80 (3.15)	40 (1.57)	12 (0.47)	M6			—	5.6 (12.32)			
	HF3080A-Z	3	420 (16.54)	410 (16.14)	380 (14.96)	340 (13.39)	160 (6.30)	130 (5.12)	90 (3.54)	100 (3.94)	50 (1.97)	15 (0.59)	55(2.17)	20(0.79)	φ6.5 (0.26)	M8	M6	56 (1.97)	11.0 (24.2)
	HF3100A-Z		300 (11.81)	260 (10.24)	240 (9.45)	220 (8.66)	420 (16.54)	105 (4.13)	97 (3.82)	105 (4.14)	25 (0.98)	100 (3.94)	60(2.36)	20(0.79)	φ6.5 (0.26)	M10	M6	18.5 (40.7)	
	HF3150A-Z		325 (12.80)	270 (10.63)	250 (9.84)	230 (9.06)	450 (17.72)	118 (4.65)	99 (3.90)	110 (4.33)	25 (0.98)	120 (4.72)	60(2.36)	20(0.79)	φ6.5 (0.26)	M12	M6	27.5 (60.5)	
	HF3200A-Z	345 (13.58)	290 (11.42)	270 (10.63)	250 (9.84)	480 (18.90)	115 (4.53)	115 (4.53)	110 (4.33)	25 (0.98)	150 (5.91)	75 (2.95)	20 (0.79)	φ6.5 (0.26)	M12	M6	35 (77.26)		
For 400 V	HF3015C-Z	1	274 (10.79)	248.5 (9.78)	230 (9.06)	210 (8.27)	110 (4.33)	80 (3.15)	60 (2.36)	70 (2.76)	35 (1.38)	12 (0.47)	R2.75(0.11) 7(0.28) Long	φ5.5 (0.22)	M4	M4	—	2.0 (4.4)	
	HF3020C-Z		274 (10.79)	248.5 (9.78)	230 (9.06)	210 (8.27)	110 (4.33)	80 (3.15)	60 (2.36)	70 (2.76)	35 (1.38)	12 (0.47)	R2.75(0.11) 7(0.28) Long	φ5.5 (0.22)	M4	M4	—	2.0 (4.4)	
	HF3030C-Z	2	355 (13.98)	330 (12.99)	320 (12.60)	285 (11.22)	120 (4.72)	90 (3.54)	70 (2.76)	80 (3.15)	40 (1.57)	12 (0.47)	R3.25(0.13) 8(0.31) Long	φ6.5 (0.26)	M5	M4	30 (1.18)	3.1 (6.82)	
	HF3040C-Z		340 (13.39)	320 (12.60)	285 (11.22)	120 (4.72)	90 (3.54)	70 (2.76)	80 (3.15)	40 (1.57)	12 (0.47)	R3.25(0.13) 8(0.31) Long	M6		—	5.6 (12.32)			
	HF3050C-Z		394 (15.51)	380 (14.96)	340 (13.39)	160 (6.30)	130 (5.12)	90 (3.54)	100 (3.94)	50 (1.97)	15 (0.59)	15 (0.59)	R3.25(0.13) 8(0.31) Long		φ6.5 (0.26)	M6	M4	50 (1.97)	10 (22)
	HF3080C-Z	420 (16.54)	410 (16.14)	380 (14.96)	340 (13.39)	160 (6.30)	130 (5.12)	90 (3.54)	100 (3.94)	50 (1.97)	15 (0.59)	15 (0.59)	55(2.17)	20(0.79)	φ6.5 (0.26)	M8	M6	11 (24.2)	
	HF3100C-Z	3	300 (11.81)	260 (10.24)	240 (9.45)	220 (8.66)	420 (16.54)	105 (4.13)	97 (3.82)	105 (4.13)	25 (0.98)	100 (3.94)	60(2.36)	20(0.79)	φ6.5 (0.26)	M10	M6	18.5 (40.7)	
	HF3150C-Z		325 (12.88)	270 (10.63)	250 (9.84)	230 (9.06)	450 (17.72)	118 (4.65)	99 (3.90)	110 (4.33)	25 (0.98)	120 (4.72)	60(2.36)	20(0.79)	φ6.5 (0.26)	M12		27.5 (60.5)	

Fig. 5.21 Dimensions of Noise Filter

5.6 I/O SIGNAL CONNECTOR

Exclusive connectors are required to connect the controllers such as the encoder, PC, or NC. Specifications, type, and dimensions of the connectors are shown in the following.

5.6.1 Connector Specifications (Soldered Type).....manufactured by Honda Communication Industry

- Minimum energizing current: 0.5mA
- Contact material: brass (male pin) phosphor-bronze (female pin)
- Surface finishing: Pretreatment: Nickel plating
Surface: Gold plating (marked with G at the end of the type name)
- Insulating material: Diallyl phthalate resin
- Casing material: ABS resin

5.6.2 Dimensions in mm (in inches)

(a) MR-50LFG (50-Pin).....For 1CN

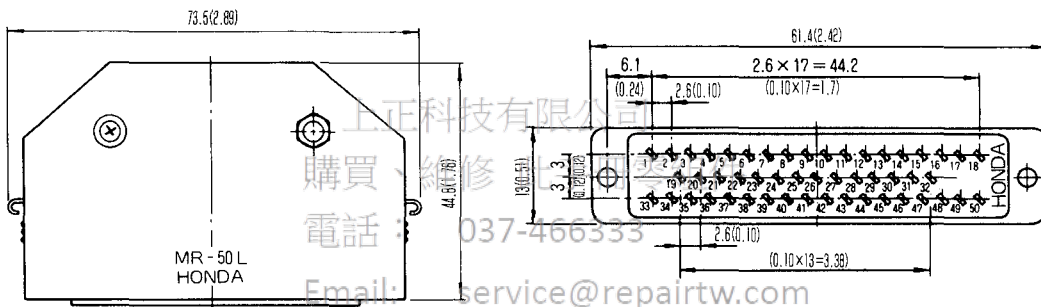

(b) MR-20LMG (20-Pin).....For 2CN, 5CN, 7CN

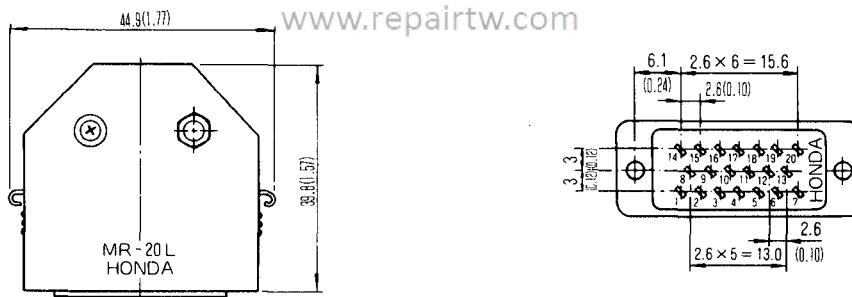

(c) MR-20LFG (20-Pin).....For 3CN, 6CN, 8CN

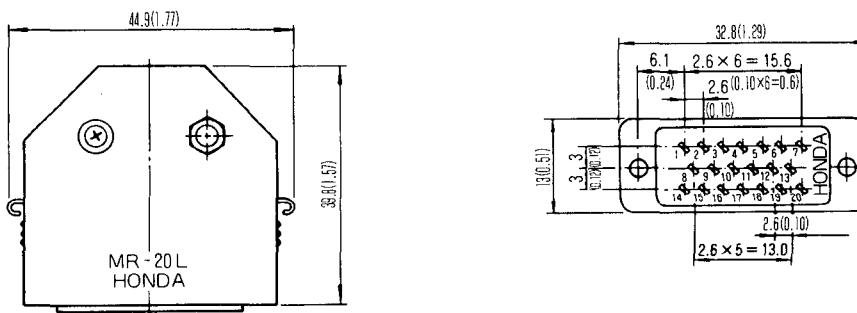

Fig. 5.22 Dimensions of I/O Signal Connector

NOTE

上正科技有限公司
購買、維修 此手冊零組件
電話： 037-466333
Email: service@repairtw.com
Line id: @zzzz
www.repairtw.com

Design Manual

This Design Manual focuses on the operating principle of VS- 626VM3 Drives, conditions to be taken into account when planning application designs, and design examples applied to actual systems.

Read the Chapters Design Manual and Explanation of Specifications in this manual before planning application designs to insure that injury or damage from misuse does not occur.

<p>6. BASIS OF INVERTER DRIVES 98</p> <p>6.1 PRINCIPLE OF INVERTER DRIVES 98</p> <p>6.2 CONFIGURATION OF THE INVERTER 99</p> <p>6.3 CHARACTERISTICS OF SQUIRREL-CAGE INDUCTION MOTORS 99</p> <p>6.4 CONTROL OF INDUCTION MOTORS BY VECTOR CONTROL 101</p> <p>7. DESIGN OF VS-626VM3 DRIVE SYSTEM 102</p> <p>7.1 BASIC DYNAMICS OF INVERTER DRIVES 102</p> <p>7.1.1 Torque 102</p> <p>7.1.2 Output from the Rotor and a Linear Motion Load 102</p> <p>7.1.3 Moment of Inertia and GD² 103</p> <p>7.1.4 Conversion of Conventional and SI Units 106</p> <p>7.2 SELECTING DRIVE CAPACITY 107</p> <p>7.2.1 Capacity for Driving the Load ... 107</p> <p>7.2.2 Accel/decel Capacity 110</p> <p>7.2.3 Calculation of Starting and Stopping Time 112</p> <p>7.2.4 Intermittent Load Operating Capacity 113</p> <p>7.3 INTERFACE DESIGN 114</p> <p>7.3.1 Sequence Input Signals 114</p> <p>7.3.2 Speed Reference Signals 115</p> <p>7.3.3 Sequence Output Signals 115</p> <p>7.3.4 Analog Monitor Signals 115</p> <p>7.4 INVERTER COOLING SYSTEM DESIGN 116</p>	<p>7.4.1 Temperature-Rise in the Control Panel 116</p> <p>7.4.2 Heat Exchanger Specifications ... 117</p> <p>8. APPLICATION DESIGN 118</p> <p>8.1 SINGLE-MOTOR OPERATION BY SPEED CONTROL WITH THE DIGITAL OPERATOR 118</p> <p>8.2 SPEED CONTROL WITH NC ... 120</p> <p>8.3 MULTI-STAGE SPEED CONTROL WITH PC 121</p> <p>8.4 WIDE RANGE CONSTANT OUTPUT BY WINDING SELECTION 123</p> <p>8.4.1 Motor Characteristics 124</p> <p>8.4.2 Winding Selection Operation 124</p> <p>8.4.3 Winding Selection Procedures 125</p> <p>8.4.4 Notes on Winding Selection Control 128</p> <p>8.5 ARBITRARY POSITION STOP CONTROL BY MOTOR ENCODER 129</p> <p>8.6 STOP AT HOME/ARBITRARY POSITION BY MAGNETIC SENSOR 132</p> <p>8.7 STOP AT ARBITRARY POSITION BY SPINDLE ENCODER 135</p> <p>8.7.1 Absolute Positioning 136</p> <p>8.7.2 Incremental Positioning 137</p>
--	---

6. BASIS OF INVERTER DRIVES

6.1 PRINCIPLE OF INVERTER DRIVES

The inverter receives commercial power and converts it into variable-frequency power. Fig 6.1 shows operations of a three-phase voltage inverter consisting of switches such as relay contacts. When S_1 makes contact, S_4 breaks. The two switches are turned ON and OFF alternately every half cycle. S_3 and S_6 , and S_2 and S_5 make and break similarly. On-off timing of the three pairs is separated from each other by a third of a cycle. Therefore, as shown in Fig. 6.2, rectangular AC voltage waves are output. The frequency of the output AC voltage is proportional to the speed of the switch on-off speed. In other words, it is inversely proportion to the cycle. This is the operating principle of the inverter.

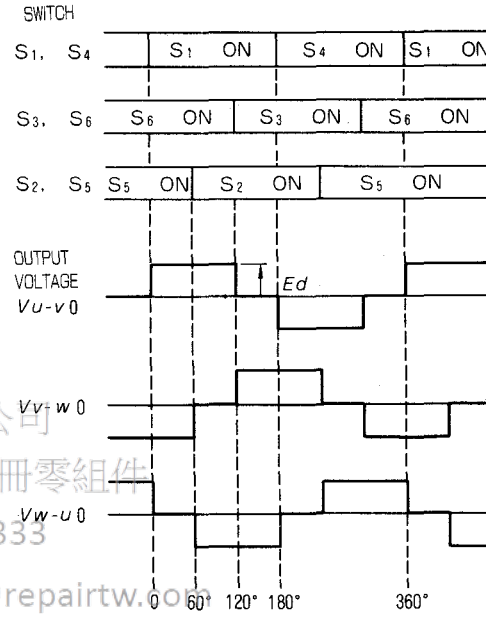
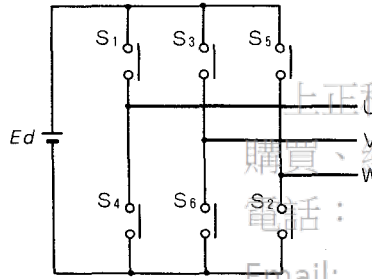

Fig. 6.1 Operating Principle of an Inverter

Fig. 6.2 Switching Operation and Output Voltage

For actual motor driving, the inverter must supply variable-voltage, variable-frequency (VVVF) power. To do this, sine wave pulse width modulation (PWM) control shown in Fig. 6.3 is used. High carrier frequency generates sine-wave current in the motor.

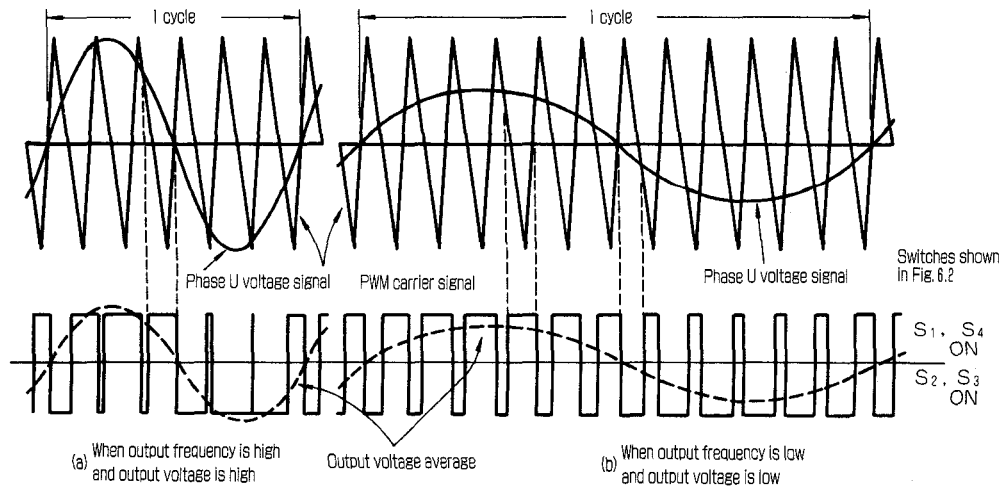

Fig. 6.3 Sine Wave PWM Control System

6.2 CONFIGURATION OF THE INVERTER

As shown in Fig. 6.4, the inverter consists of three blocks: The converter rectifies commercial power and converts it into DC; the main circuit capacitor smoothes the rectified voltage, and the inverter changes DC to AC of a required frequency. Since VS-626VM3 has the power supply regenerative function, both the converter and the inverter use IGBTs.

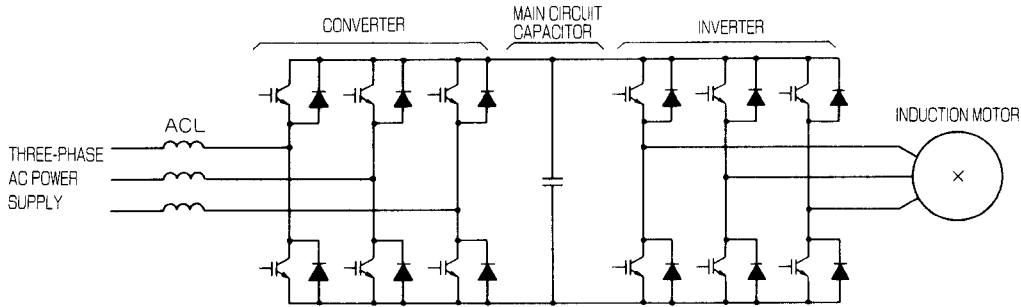

Fig. 6.4 Configuration of Inverter

6.3 CHARACTERISTICS OF SQUIRREL-CAGE INDUCTION MOTORS

In the following, characteristics of the squirrel-cage induction motor are compared to the DC motor to explain the principle of generating torque.

A DC motor generates electromagnetic torque in proportion to the product of the magnetic flux of the field current and the current flowing in the armature winding. Torque control is easy with this type of motor because the field winding where field current flows is separated from the armature winding.

On the other hand, a squirrel-cage induction motor consists of a stator with the stator winding and a rotor having a squirrel-cage structure. When three-phase AC flows in the rotor winding, rotating magnetic field of a magnetic flux of ϕ_m develops. This magnetic field is equivalent to the magnetic flux generated by field current of a DC motor.

Magnetic Flux ϕ_m is represented in the following formula:

$$\phi_m = M I_m \dots\dots\dots(6.1)$$

The current in the above formula is called magnetizing current I_m , which approximately equals the no-load current of a squirrel-cage induction motor.

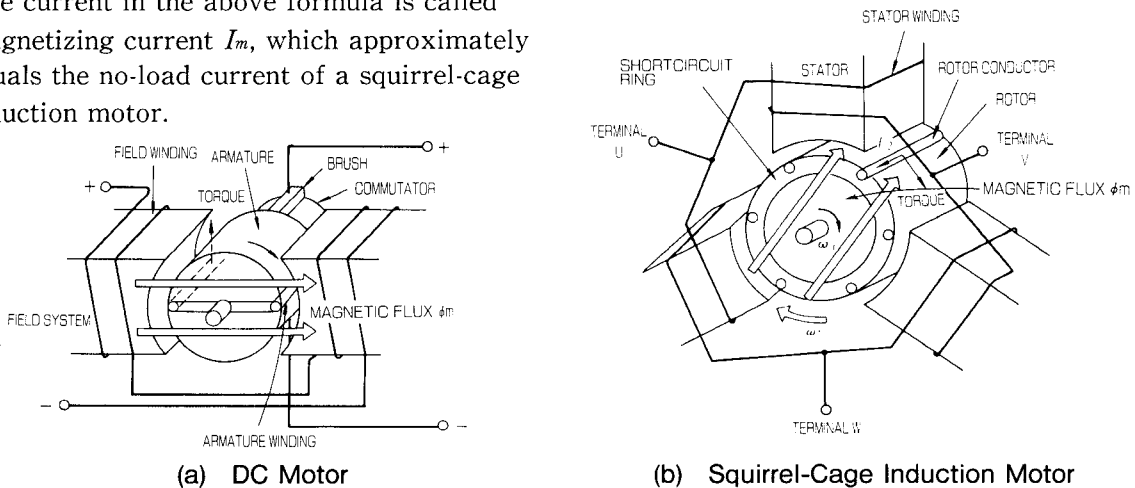

Fig. 6.5 Structures of Motors (Viewed from Axis Direction)

As shown in Fig. 6.5, the rotor is placed within the stator, that is, in the rotating magnetic field. If rotor angular speed ω_r is not matched with rotating field angular speed ω_1 , the rotor conductor crosses the alternating magnetic field having an angular speed of the difference. As a result, electromagnetic induction generates secondary induced electromotive force E_2 in the rotor conductor. On the other hand, the stator winding crosses the rotating field flux and electromagnetic induction generates counter electromotive force in the stator.

$$E_1 = k\omega_1 \quad \phi_m = 2\pi kf_1 \phi_m \dots\dots\dots(6.2)$$

The rotor, as it is called in the squirrel-cage, has the rotor conductor with both ends connected to the shortcircuit ring. Thus secondary induced electromotive force E_2 generates secondary current I_2 . This current is equivalent to the armature current for a DC motor. As in the case of the DC motor, electromotive force generates torque proportional to the product of secondary current I_2 and magnetic flux ϕ_m , and the rotor is turned as a result. The ratio of the speed difference of the rotor and rotating field to rotor speed is called "slip" of the induction motor. If the speed of the rotor matches that of the rotating field, their relative position is unchanged, causing no electromagnetic induction and no torque. This speed is called synchronous speed. Synchronous speed and slip are obtained by the following calculation:

$$\text{Synchronous speed } N = \frac{120f}{P} \text{ (r/min)} \dots\dots\dots(6.3)$$

$$\text{Slip } S = \frac{N - N_r}{N} \dots\dots\dots(6.4)$$

Where,
 [N_r : Rotor speed (r/min.), f : Power frequency (Hz), P : Motor pole number]
 電話： 037-466333
 Email: service@repairtw.com

If the phase order is reversed by exchanging the phases of the three-phase AC, the rotating field turns in a reverse direction, and the motor does also. As explained above, the squirrel-cage induction motor is an energy converter that changes electric power (electric energy) to torque and speed (mechanical energy) by adjusting slip and generating necessary primary current to obtain a required torque. A drawback of this motor is the inability of direct control of rotating field flux and secondary current. Control technics are required to compensate for this.

6.4 CONTROL OF INDUCTION MOTORS BY VECTOR CONTROL

Vector control was devised to provide a squirrel-cage induction motor with control function the same as that of a DC motor. The control method, called slip frequency control method, requires a speed detector, which detects speed as a reference for control. Most presently-used vector control inverters now employ this method.

Vector control is an application of the torque generating principle of the squirrel-cage induction motor to control the inverter. Primary current I_1 supplied to the induction motor according to torque reference is distributed in the motor according to setup values as magnetizing current I_m and secondary current I_2 , so as to generate a required torque. The speed controller matches speed reference ω_r^* and detected speed ω_r , notified by speed detector signal by outputting secondary current reference value I_2^* via the secondary current reference limiter. For standardization of signals, rated speed settings and speed adjustment parameters are prepared. Gain and integral time of the speed controller can be selected according to the mode of control.

The flux command function receives detected speed ω_r and outputs flux reference value ϕ^* for constant output control.

The vector controller is based on the torque generating principle. It receives secondary current instruction value I_2^* , flux reference value ϕ^* , and detected speed ω_r , and generates primary current reference value I_1^* and determines the frequency and phase of the current.

Select parameters for different motors with motor codes. The current controller performs PWM so that exact primary current flows as commanded by the reference vector I_1^* and a required torque is generated.

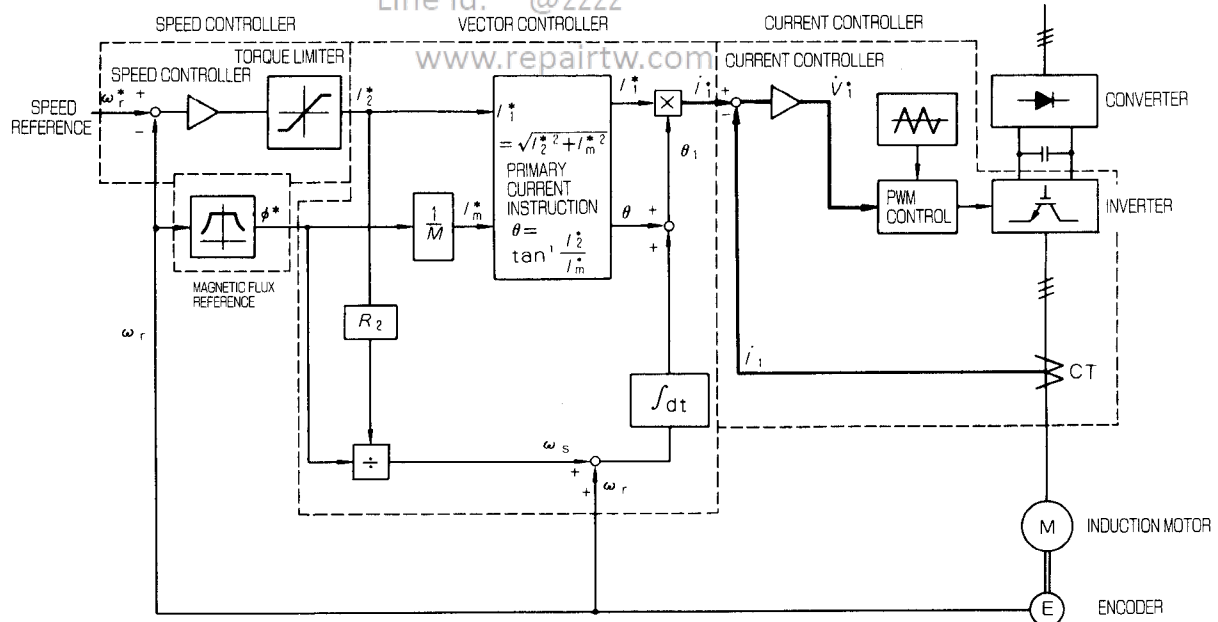

Fig. 6.6 Control Block Diagram of VS-626VM3

7. DESIGN OF VS-626VM3 DRIVE SYSTEM

7.1 BASIC DYNAMICS OF INVERTER DRIVES

Torque, power, and moment of inertia, which are basic factors for selecting motor and inverter capacities, are explained in the following.

7.1.1 Torque

Torque of the rotor is an impetus that tends to rotate it around the rotary axis (See Fig. 7.1.). When an external force of f (newtons) is applied in the direction of the tangent at point P at a distance of r (meters) from the center of rotation (point O), then torque T is computed as follows:

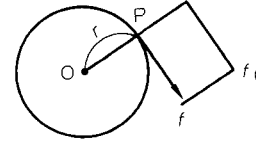

Fig. 7.1 Definition of Torque

$$T = f \cdot r \text{ (N} \cdot \text{m)} \dots\dots\dots(7.1)$$

When transmission gear is used as shown in Fig. 7.2, torque varies in proportion to the transmission ratio. When motor axis speed is N_M (r/min) and load axis speed is N_L (r/min), motor axis converted torque is T_M (N·m):

$$T_M = \frac{N_L \cdot T_L}{N_M} = \frac{T_L}{a} \text{ (N} \cdot \text{m)} \dots\dots\dots(7.2)$$

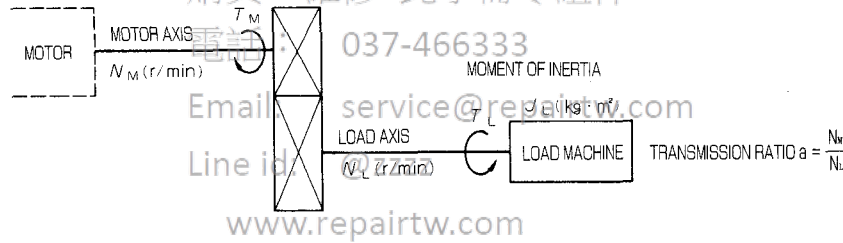

Fig. 7.2 Torque Calculation When Transmission Gear is Used

7.1.2 Output from the Rotor and a Linear Motion Load

When torque of T (N·m) is applied to the rotor moving at a speed of N (r/min), the output is P_R (watts):

$$P_R = \frac{2\pi NT}{60} = 0.1048NT \text{ (W)} \dots\dots\dots(7.3)$$

When the load is moved in linear as shown in Fig. 7.3 at a speed of V (meters per minute) by a force of F (newtons), the output is P_L (watts):

$$P_L = \frac{FV}{60} = 0.0167FV \text{ (W)} \dots\dots\dots(7.4)$$

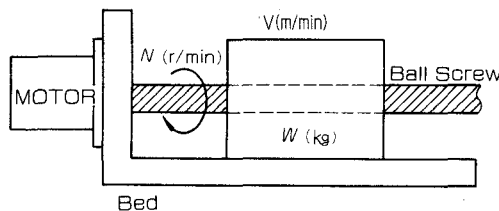

Fig. 7.3 Output for Linear Motion

7.1.3 Moment of Inertia and GD^2

Moment of Inertia of the rotor is the tendency to continue rotation. When the entire mass of the rotor is m (kilograms) and the diameter of rotation is r (meters), the moment of inertia is J (kilogram square meters).

$$J = mr^2 \text{ (kg}\cdot\text{m}^2) \dots\dots\dots(7.5)$$

There is the following relation between moment of inertia and conventional fly-wheel effect GD^2 :

$$J = \frac{GD^2}{4} \text{ (kg}\cdot\text{m}^2) \dots\dots\dots(7.6)$$

Calculations of moment of inertia for objects of various geometrical shapes are shown in the following. Friction and other losses are disregarded and efficiency is assumed as 100%.

(1) Moment of inertia of a solid cylinder

When a solid cylinder having a mass of m_1 (kilograms) and a diameter of r_1 (meters) rotates around its axis, the moment of inertia is J_1 (kilogram square meters):

$$J_1 = \frac{m_1 r_1^2}{2} \text{ (kg}\cdot\text{m}^2) \dots\dots\dots(7.7)$$



Fig. 7.4 Moment of Inertia of a Solid Cylinder

(2) Moment of inertia of a hollow cylinder

When a hollow cylinder having a mass of m_2 (kilograms) and an outer diameter of r_1 (meters) and an inner diameter of r_2 (meters) rotates around the cylinder axis, the moment of inertia is J_2 (kilogram square meters):

$$J_2 = \frac{m_2(r_1^2 - r_2^2)}{2} \text{ (kg}\cdot\text{m}^2) \dots\dots\dots(7.8)$$

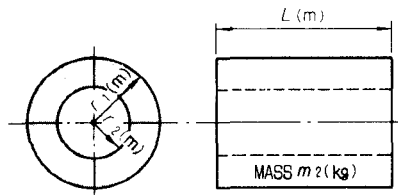

Fig. 7.5 Moment of Inertia of a hollow cylinder

(3) Moment of Inertia of a suspended load

Moment of Inertia of a suspended load J_3 shown in Fig. 7.6 is represented by formula (7.9) since the entire load is applied to the contact point between the rope and the pulley.

$$J_3 = m_3 r_1^2 \text{ (kg} \cdot \text{m}^2) \text{(7.9)}$$

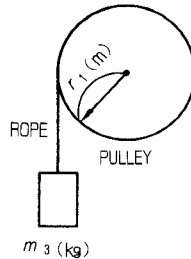

Fig. 7.6 Moment of Inertia of a Suspended Load

(4) Moment of inertia of a Linear Motion Load

Fig. 7.7 shows linear motions where the motor drives the ball screw to move the table. Part (a) shows horizontal motion whereas (b) shows vertical motion. Assume the entire mass of the load is m_L (kilograms), mass of the counter weight is m_C (kilograms), and ball screw lead is P_B . Inertial momenta J_H and J_V in (a) and (b) are calculated as follows:

$$J_H = \frac{m_L P_B^2}{4\pi^2} \text{ (kg} \cdot \text{m}^2) \text{(7.10)}$$

$$J_V = \frac{(m_L + m_C) P_B^2}{4\pi^2} \text{ (kg} \cdot \text{m}^2) \text{(7.11)}$$





(a) Horizontal motion

(b) Vertical motion

Fig. 7.7 Moment of Inertia of Linear Motion Load

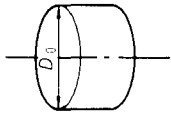
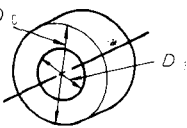
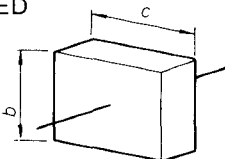
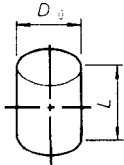
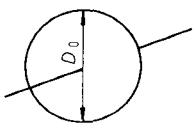
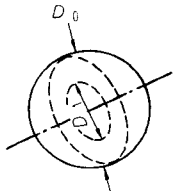
Table 7.1 Rotor Diameter

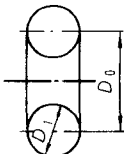
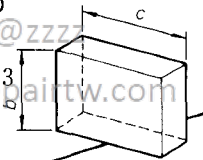
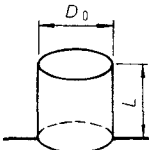
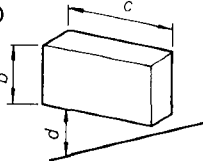
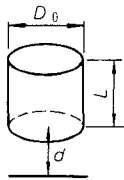
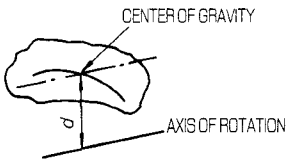
<ul style="list-style-type: none"> When axis of rotation equals center line of cylinder. 	<p>SOLID CYLINDER</p> $(D^2 = D_0^2 / 2)$ 	<p>HOLLOW CYLINDER</p> $D^2 = (D_0^2 + D_1^2) / 2$ 
<ul style="list-style-type: none"> When axis of rotation goes through the center of gravity. 	<p>RECTANGULAR PARALLELOPIPED</p> $D^2 = (b^2 + c^2) / 3$ 	<p>CYLINDER</p> $D^2 = L^2 / 3 + D_0^2 / 4$ 
	<p>SPHERE</p> $D^2 = \frac{2}{5} D_0^2$ 	<p>HOLLOW SPHERE</p> $D^2 = \frac{2}{5} \cdot \frac{D_0^5 - D_1^5}{D_0^3 - D_1^3}$ 
	<p>CONE</p> $D^2 = \frac{3}{10} D_0^2$ 	<p>CIRCLE</p> $D^2 = D_0^2 + \frac{3}{4} D_1^2$ 
<ul style="list-style-type: none"> When axis of rotation is at one end of rotor. 	<p>RECTANGULAR PARALLELOPIPED</p> $D^2 = (4b^2 + C^2) / 3$ 	<p>CYLINDER</p> $D^2 = \frac{4}{3} L^2 + \frac{D_0^2}{4}$ 
<ul style="list-style-type: none"> When axis of rotation is outside rotor. 	<p>RECTANGULAR PARALLELOPIPED</p> $D^2 = \frac{4b^2 + C^2}{3} + 4(bd + d^2)$ 	<p>CYLINDER</p> $D^2 = \frac{4}{3} L^2 + \frac{D_0^2}{4} + 4(dL + d^2)$ 
<ul style="list-style-type: none"> General formula when axis of rotation is outside rotor. 	<p>How to calcula diameter of rotation when axis of rotation is outside body of rotation.</p> $D_2^2 = D_1^2 + 4d^2$ <p>D_1 : Diameter of rotation when axis of rotation is temporarily considered to be the axis which is parallel to axis of rotation and goes through the center of gravity.</p> 	

(5) Moment of inertia converted to motor axis momentum when transmission gear is used
 Acceleration or deceleration gears and pulleys may be used to obtain a required speed of the machine. When the transmission ratio in Fig. 7.2 is a , the load moment of inertia is converted to motor axis momentum as follows:

$$J_M = \frac{N_M^2 J_L}{N_L^2} = \frac{J_L}{a^2} \text{ (kg} \cdot \text{m}^2) \text{(7.12)}$$

Table 7.1 lists rotor diameters of simple geometrical shapes.

7.1.4 Conversion of Conventional and SI Units

This document uses the SI system. Some quantities represented in the conventional system of units need to be converted. Table 7.2 provides conversion rates for major units from the gravitational system into the SI system.

Table 7.2 Conversion Table from Conventional System of Units to the SI System

Measured Factor	Conventional unit	SI unit	Conversion rate
Force, load	kgf	N	kgf=9.80665N
Weight	kgf	-	The weight in conventional system of units is the same as the mass in the SI system of units. [An object having a weight of w(kgf) in the conventional system of units has a mass of w(kg) in the SI system.]
Mass	kgf · s ² /m	kg	
Torque	kgf · m	N · m	1kgf · m=9.80665N · m
Moment of Inertia	gf · cm · s ²	kg · m ²	1gf · cm · s ² =9.80665 × 10 ⁻⁵ kg · m ²
Speed (Rotation number)	rpm	r/min	1rpm=1r/min
Vibration	G	m/s ²	1G=9.80665m/s ²

Note : The conventional GD² is an moment of inertia of 4 joules

www.repairtw.com

7.2 SELECTING DRIVE CAPACITY

To control the speed of machine, the inverter drive must apply load torque according to the characteristics of the load machine and accel/decel torque for accelerating and decelerating the drive system. The system consists of the motor, machine, and coupling. To determine the drive capacity, consider the following:

- (1) According to load characteristics, determine the operating ratings (continuous rating, short-time rating, and repetitive rating).
- (2) With consideration for power transmission system efficiency and load dispersion, select a drive capacity greater than the required power for the load.
- (3) Select a drive that allows the starting torque and the maximum torque required for the load.

To determine a drive capacity, use the following formula:

(Drive capacity) \geq (Power for driving the load machine)

+ (Power for accelerating and decelerating the load machine to achieve a required speed).

Calculation of the load driving power and the accel/decel power is shown in the following:

7.2.1 Capacity for Driving the Load

Table 7.3 classifies torque-speed characteristics of load machines for which VS-626VM3 Drives are applied. Typical examples of driving capacity calculations are explained below.

Table 7.3 Typical Load Torque - Speed Characteristics

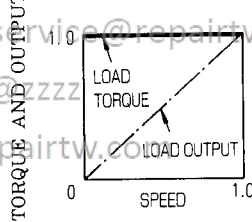
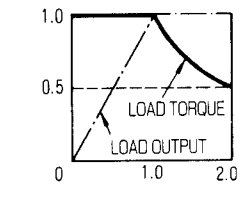
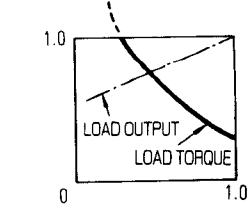
Load Characteristics	Actual Load Examples	Torque-speed characteristics	Motor Capacity
Constant Torque Load Constant Load Torque is required regardless of speed. Frictional load is typical constant torque load.	<ul style="list-style-type: none"> • Conveyers • Cranes • Winches • Other frictional loads and gravitational loads 	 <ul style="list-style-type: none"> • Load torque is constant regardless of speed. • Output is proportional to speed. 	Required motor capacity is the same as the load capacity at the maximum speed.
Constant output load Constant output is required regardless of speed.	<ul style="list-style-type: none"> • Constant tension winders of a center drive • Spindle of a milling machine • Vernier rotary lathe 	 <ul style="list-style-type: none"> • In the constant torque area, Load torque is constant regardless of speed. • Output is proportional to speed • In the constant output area, Load requires constant output, and Load torque is in reverse proportion to speed. 	Required rated output for using drives having constant torque characteristics is determined as follows: [Required output] = [Load output] × [Constant output control ratio] 1/2
Variable output load Required load torque varies depending on speed. Characteristics of this type of load is between that of constant output load and constant torque load.		 <ul style="list-style-type: none"> • Torque-speed, output characteristics are a compromise between that of constant output load and constant torque load. 	Required motor capacity is the same as the load capacity at the maximum speed.

(1) Driving the spindle of Machine Tools

Power required for driving the spindle of a lathe or a machining center is determined by the cutting power.

Cutting requires constant output characteristic, with constant output control range from 1:10 to 1:30. Required powers for cutting with a lathe, milling and drilling with a machining center are calculated as follows. (For precise calculation of required power, cutting resistance factors such as conditions of cutting oil, material, shape of cutting tools, and hardness of the workpiece must be taken into consideration.)

For cutting with a lathe, a cutting blade is pressed against the workpiece being rotated as shown in Fig. 7.8.

Required cutting power P_c is calculated as follows:

$$P_c = \frac{K_s d L V}{60 \times 1000 \times \eta_c} = \frac{d L V}{S_c \cdot \eta_c} \text{ (kW)} \dots\dots\dots(7.13)$$

$$V = \frac{\pi D N_s}{1000} \text{ (m/min)} \dots\dots\dots(7.14)$$

Where,

- K_s : Relative cutting resistance (N/mm²)
- d : Cutting depth (mm)
- L : Actual cutting blade length, that is, feed length per rotation (mm)
- D : Workpiece diameter (mm)
- N_s : Spindle speed (r/min.)
- η_c : Mechanical efficiency (0.7 to 0.85)
- s_c : Cutting efficiency, that is, cutting volume per kilowatt per minute (CC/kW/min.)

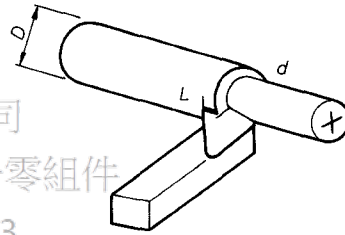

Fig. 7.8 Example of Cutting

For milling, a cutting blade is mounted on the spindle and rotated to cut the workpiece as shown in Fig. 7.9. Required cutting power P_F is calculated as follows:

$$P_F = \frac{K_s \delta W_f}{60 \times 1000^2 \times \eta_F} = \frac{\delta W_f}{1000^2 S_F \eta_F} \text{ (kW)} \dots\dots\dots(7.15)$$

Where,

- K_s : Relative cutting resistance (N/mm²)
- δ : Cutting depth (mm)
- W : Cutting width (mm)
- f : Feed rate (mm/min.)
- s_F : Cutting efficiency, that is, cutting volume per kilowatt per minute (CC/kW/min.)
- η_F : Mechanical efficiency (0.7 to 0.8)

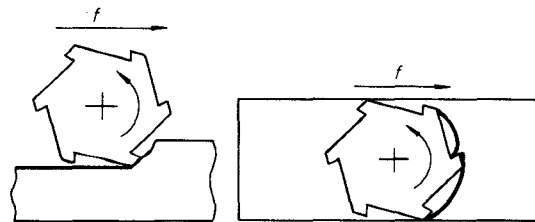

(a) Plain milling machine (b) Face milling machine

Fig. 7.9 Example of Milling

For drilling, a cutting blade (drill bit) is mounted on the spindle and rotated to bore the workpiece as shown in Fig. 7.9. Required cutting power P_D is calculated as follows:

$$P_D = \frac{M \cdot 2\pi n}{60 \times 100 \times 1000 \times \eta_b} = \frac{\pi D^2 f}{4 \times 1000 \times S_b \eta_b} \text{ (kW)} \dots\dots\dots(7.16)$$

Note that load torque M varies depending on the material, drill diameter D , and feed rate f .

Where,

- M : Drill load torque (N·cm)
- n : Spindle speed (r/min.)
- η_b : Mechanical efficiency (0.7 to 0.85)
- D : Drill diameter (mm)
- f : Feed rate (mm/min.)
- S_b : Cutting efficiency, that is, cutting volume per kilowatt per minute (CC/kW/min.)

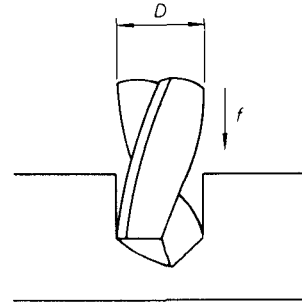

Fig. 7.10 Example of Milling

(2) Driving a gravitational load

Power required to move a load vertically with a crane or lift largely depends on the presence or absence of counter weights. Calculations of required power in either case are shown in the following:

With counterweight $P_{GL} = \frac{m_L V}{6120 \eta}$ (kW)

Without counterweight $P_{GLC} = \frac{(m_L + m_c)V}{6120 \eta}$ (kW)

Where,

- V : Lifting-lowering speed (m/min.)
- η : Mechanical efficiency
- m_L : Load mass (kg)
- m_c : Counterweight mass (kg)

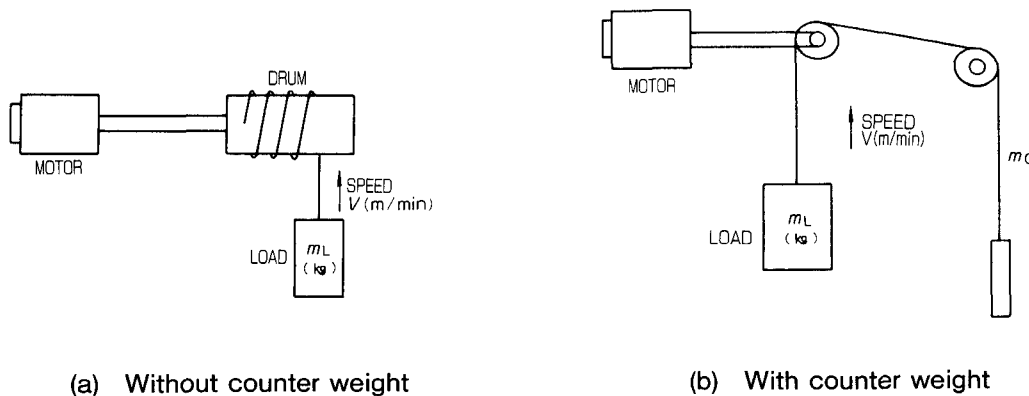

Fig. 7.11 Gravitational Load

(3) Driving a frictional load

Carrier equipment that makes horizontal motion such as a traveling crane or table is a frictional load. When the coefficient of friction is μ , required power P_F is obtained as follows:

$$P_F = \frac{\mu m_L V}{6120 \eta} \text{ (kW)} \dots\dots\dots (7.19)$$

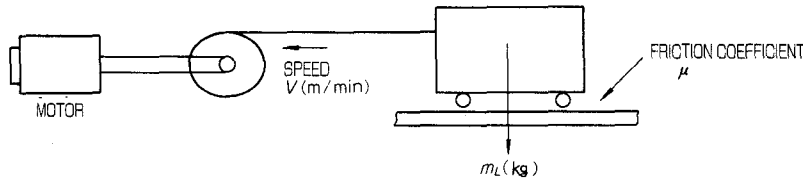

Fig. 7.12 Frictional Load

7.2.2 Accel/decel Capacity

Acceleration method can be selected from rapid to smooth, gradual accel/decel. Table 7.4 compares the acceleration methods. Capacity of accel/decel is determined under current-limiting acceleration conditions, which requires the greatest capacity. Since VS-626VM3 employs power regenerative control, acceleration and deceleration capacity are the same. When acceleration time is t seconds, required drive capacities are determined as shown in equations (7.20) and (7.21).

- Required drive capacity in the constant torque characteristic area ($0 \leq N_M \leq N_B$)

$$P_M = \left(\frac{2\pi}{60}\right)^2 \frac{J_M N_M^2}{1000t} \text{ (kW)} \dots\dots\dots (7.20)$$

- Required drive capacity in the constant torque and constant output characteristic area ($0 \leq N_M \leq N_{MAX}$)

$$P_M = \left(\frac{2\pi}{60}\right)^2 \frac{J_M(N_M^2 + N_B^2)}{2000t} \text{ (kW)} \dots\dots\dots (7.21)$$

Where,

- J_M : Motor axis converted inertial momentum (kg.m²)
- P_M : Motor output at the Base speed (kW)
- N_M : Operating speed (r/min.)
- N_B : Base speed (r/min.)
- N_{MAX} : Maximum speed (r/min.)

Table 7.4 Acceleration Method

Acceleration Method	Control Method	Explanatory Diagram	Remarks
Current-limiting acceleration	Current is suppressed at a constant level during acceleration to protect the driving equipment and load machines.		During acceleration, motor generates constant torque.
Time-limiting acceleration	Acceleration rate is suppressed to change speed linearly in time upon receipt of rapid change of speed reference.		Acceleration torque is constant.
S-shape acceleration	Adding to time-limiting acceleration, changes of torque are suppressed for smooth acceleration.		Torque variation rate is suppressed at starting and ending of acceleration.

Email: service@repairtw.com

Examples of calculating using standard mechanical and drive specifications are shown in the following. The values may differ from those obtained in actual operation, because of mechanical loss, power voltage fluctuations, or countermeasures against mechanical and magnetic noises.

(1) Conditions

- Acceleration time : 2.5 s (0 to 6000 r/min.)
0.5 s (0 to 1500 r/min.)
- Moment of inertia J_M : 0.13 kg.m²
Load : 0.10 kg.m²
Motor: 0.03 kg.m² (assumed as three times the load)
- Output characteristic (30-minute rating)
Base speed N_B : 1500 r/min.

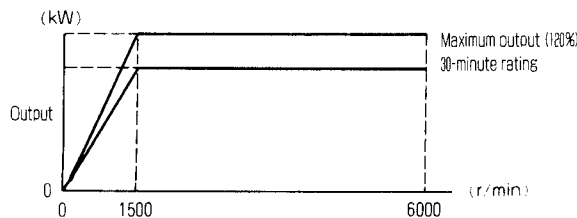

- Maximum output during accel/decel : 120% of 30-minute rating output

(2) Calculations

① When speed is 0 to 1500 r/min.

$$P_M = \left(\frac{2\pi}{60}\right)^2 \frac{0.13 \times 1500^2}{1000 \times 0.5} = 6.41 \text{ (kW)}$$

② When speed is 0 to 6000 r/min.

$$P_M = \left(\frac{2\pi}{60}\right)^2 \frac{0.13 \times (6000^2 + 1500^2)}{2000 \times 2.5} = 10.89 \text{ (kW)}$$

Consequently, required power based on accel/decel time is determined as follows:

For ① : 7.5 kW (47.7 N · m), 30-minute rating

For ② : 15 kW (95.0 N · m), 30-minute rating

7.2.3 Calculation of Starting and Stopping Time

After selecting mechanical characteristics and inverter capacity, starting and stopping time is determined as follows. Motor characteristics are explained in Tables 1.1 to 1.3.

• Constant torque characteristic ($0 \leq N_M \leq N_B$)

$$t_1 = \frac{2\pi J_M N_M}{60 T_M} \text{ (s)} \dots\dots\dots(7.22)$$

• Constant output characteristic ($N_B \leq N_M \leq N_{MAX}$)

$$t_2 = \frac{2\pi J_M (N_M^2 - N_B^2)}{120 T_M N_B} \text{ (s)} \dots\dots\dots(7.23)$$

• Constant torque and constant output characteristic ($0 \leq N_M \leq N_{MAX}$)

$$t_3 = t_1 + t_2 = \frac{2\pi J_M (N_M^2 + N_B^2)}{120 T_M N_B} \text{ (s)} \dots\dots\dots(7.24)$$

Where,

J_M : Motor axis converted inertial momentum (kg · m²)

T_M : Motor axis torque at the base speed (N · m)

N_M : Operating speed (r/min.)

N_B : Base speed (r/min.)

N_{MAX} : Maximum speed (r/min.)

上正科技有限公司
電話： 037-466333
Email: service@repairtw.com
@zzzz
www.repairtw.com

7.2.4 Intermittent Load Operating Capacity

When a reversible operation such as tapping with a milling machine or driving a carrier table is repeated frequently, drive capacity must be determined with care. For operation cycle including accel/decel shown in Fig. 7.13, motor equivalent effective torque T_R in equation (7.25) must be within the continuous rating torque of the inverter. (The maximum value of T_P is 120% of the 30-minute rating of the inverter.)

$$T_R = \sqrt{\frac{T_P^2(t_r + t_t) + T_L^2 t_s}{t_c}} \quad (\text{N} \cdot \text{m}) \quad \dots\dots\dots(7.25)$$

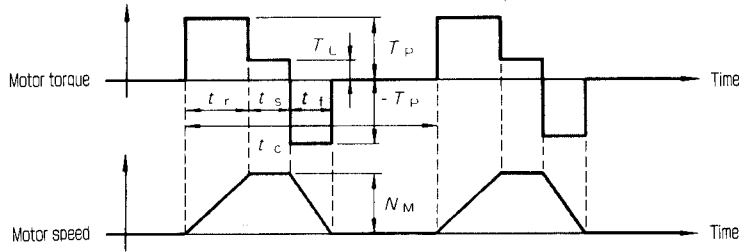

Fig. 7.13 Time Chart of Motor Torque and Speed

The motor repetitive rating is a rating for a motor load that varies periodically. When duration of repetitive rating output is t_1 and duration of no-load operation is t_2 , value a in the following equation is called percent Einschalt Dauer (%ED).

$$a = \frac{t_1}{t_1 + t_2} \times 100 \quad (\%) \quad \dots\dots\dots(7.26)$$

Total of t_1 and t_2 is specified as 10 minutes.

7.3 INTERFACE DESIGN

7.3.1 Sequence Input Signals

Among other input signals, sequence input signals that control status of operation such as forward and reverse run or torque limiting can be turned ON and OFF by either the relay contact or the transistor switch, as shown in Fig. 7.14. The common in the signal circuit can be selected from 0V common and +24V common that use the inverter power source, and external common that uses separate +24V power source, as shown in Fig. 7.15. For explanations of the signals, see Table 4.9.

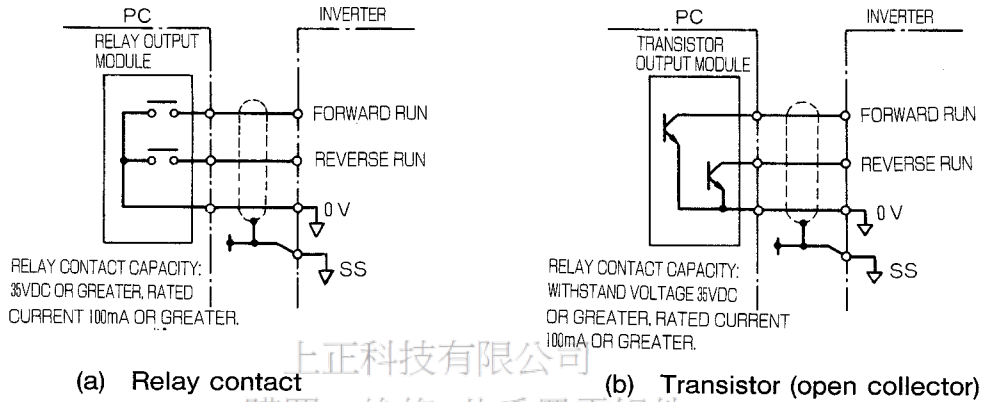

Fig. 7.14 Example of Connection of Operation Signals

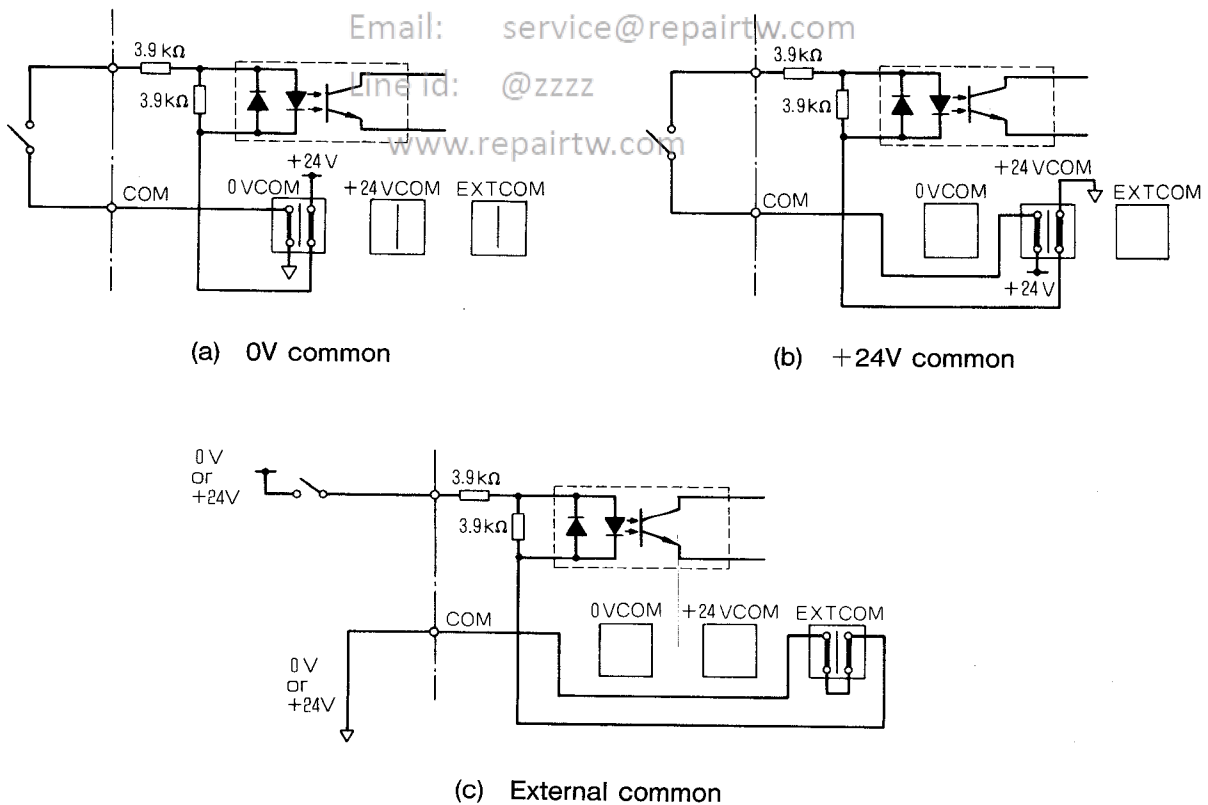

Fig. 7.15 Input Interface Circuit

7.3.2 Speed Reference Signals

For speed reference signal, analog or digital signal can be used as shown in Fig. 7.16 and 7.17. With analog signal, $\pm 10\text{V}$ is the rated speed reference. Voltage reduction caused by cable impedance or drift from thermal or aging degradations can be adjusted using the adjustment resistor or control parameters on the PC or NC, or by control parameters on the inverter.

Digital speed reference signals are coded by BCD or binary method. With this type of signal, unlike with analog signals, no reference error is caused by voltage reduction or thermal drift. If speed changes do not need to be continuous, multi-stage speed operation is possible by externally switching internal speed setup parameters of the inverter. The input circuit for digital speed reference is the same as that shown in Fig. 7.15. Selection of the common of the signal circuit is the same as that for sequence input signals.

For explanations of the signals, see Table 4.11.

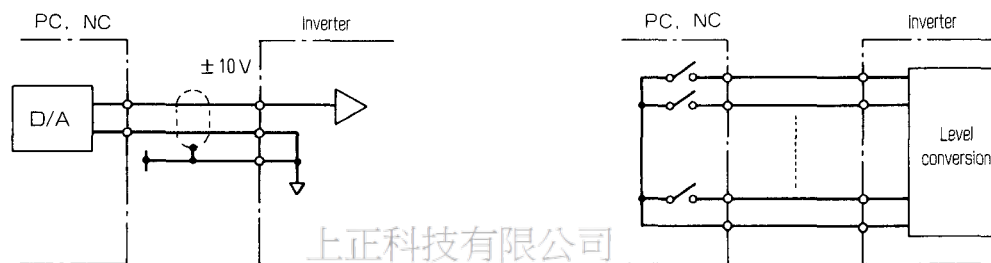

Fig. 7.16 Example of Analog Speed Reference Signal

Fig. 7.17 Example of Digital Speed Reference Signal

7.3.3 Sequence Output Signals

Sequence output signals that notify status of operations of the inverter such as zero-speed and failures can be turned ON and OFF by either the relay contact or the transistor switch. The output circuit of the transistor switch is bilateral as shown in Fig. 7.18, thus the common can be selected from 0V common and +24V common similar to relay output.

For explanations of the signals, see Table 4.12.

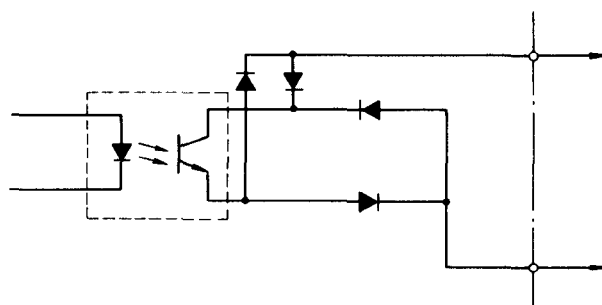

Fig. 7.18 Output Interface Circuit

7.3.4 Analog Monitor Signals

The inverter outputs two monitor signals: speedometer signal and load ratio meter signal. Use a voltmeter with a full scale of +10V, or an analog input module such as PC. Cable extensions for these monitor signals must be 20 meters or shorter. If a longer cable is used or the cable undergoes noise interference, it is effective to place an insulated amplifier in the line. For explanations of the signals, see Table 4.13.

7.4 INVERTER COOLING SYSTEM DESIGN

When the inverter is housed in the control panel, leave a clearance around the inverter for ease of maintenance and ventilation. The clearance must be 30 millimeters or greater on the left and right, and 150 millimeters or greater above and below. Two types of inverter enclosures are available: one is the heat sink external cooling type for a totally-enclosed control panel, and the other is the open-chassis type to be entirely contained in the control panel. Loss in the control panel is reduced by the use of the heat sink external cooling type, because most loss from the inverter is cooled directly by external air.

The upper limit of inverter operating temperatures is +55°C. Suppress the maximum ambient temperature around the control panel to +40°C and the average temperature rise in the control panel to 10 K (10°C) or less. Naturally, heat resulting from inverter generation loss must be dissipated by forced air cooling or a heat exchanger. Table 7.5 shows generation losses at different inverter capacities.

Table 7.5 Inverter Generation Loss

Inverter Model CIMR-VM		23P7		25P7		27P5		2011		2015		2018		2022		2030		2037		
Output		Continuous	30-minute	Continuous	30-minute	Continuous	30-minute	Continuous	30-minute	Continuous	30-minute	Continuous	30-minute	Continuous	30-minute	Continuous	30-minute	Continuous	30-minute	
Calorific Value (W)	Built-in Type	232	326	345	475	462	608	546	786	789	1056	1027	1279	1365	1623	1416	1952	1600	2078	
	Totally-enclosed Type	Outside of heat sink	101	181	203	306	301	417	364	559	571	785	747	949	1037	1241	1072	1500	1206	1569
		Inside of heat sink	131	145	142	169	161	191	182	227	218	272	280	330	328	383	344	452	394	509
Front Air Capacity (m ³ /min)		1.8				3.5				5.1				6.4						

7.4.1 Temperature Rise in the Control Panel

When panel internal heat output is P (watts), heat transfer rate is k (watts per square meter per degree Celsius), control panel surface area directly exposed to external air is A (square meters), control panel internal temperature rise ΔT (K) is calculated as follows.

$$\Delta T = \frac{P}{k \times A} \text{ (K)} \quad \text{.....(7.27)}$$

Value k depends on conditions as follows:

- With no internal circulation fan: 4 (W/m² · °C)
- With internal circulation fan: 6 (W/m² · °C)
- Forced air cooling by air duct (with internal circulation fan): 9 (W/m² · °C)

When a heat exchanger is used, internal temperature rise ΔT (K) is calculated as follows.

$$\Delta T = \frac{P}{k \times (A - B) + qh} \quad \text{.....(7.28)}$$

Where,

(qh : Heat exchanger cooling capacity (W/°C)

B : Heat exchanger surface area (m²)

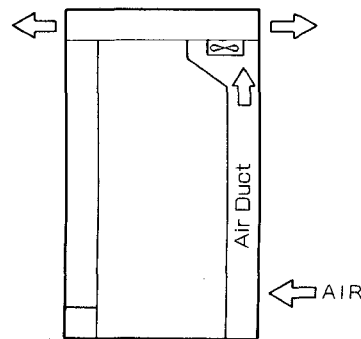

Fig. 7.19 Structure of control panel with air duct

7.4.2 Heat Exchanger Specifications

Heat exchangers listed in Table 7.6 are provided for improvement of control panel cooling performance.

Table 7.6 Heat Exchanger Specifications

Heat exchanger	Cooling capacity	Dimensions (mm)	Installation Area (m ²)
REX1550	110W/ 10°C	295W/ 890 H/ 50D	0.31
HEATEX02	250W/ 10°C	440W/ 924H / 50D	0.45

W(Width), H(Height), D(Depth) (Manufactured by YASKAWA)

Heat output during the cooling process is the allowable heat output needed to suppress temperature rise in the cabinet to 10 K (10°C) or less.

Mount the heat exchanger inside the cabinet as shown in Fig. 7.20. Internal air is circulated from the top of the cabinet to downward, and Cooling air is taken from the bottom and directed upward.

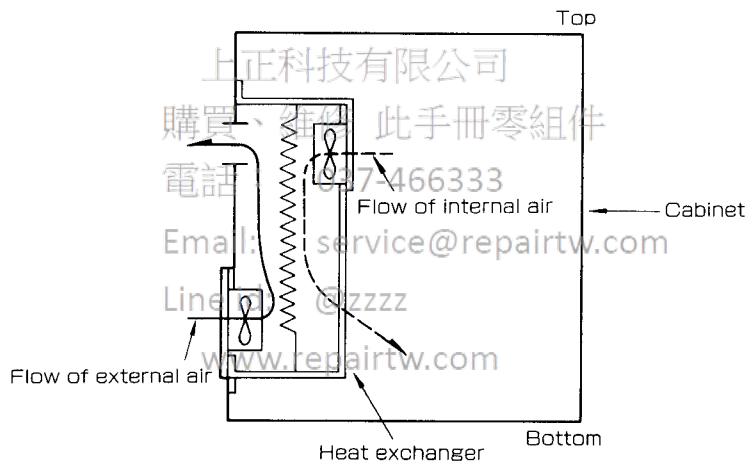

Fig. 7.20 Example of Installation of Heat Exchanger

8. APPLICATION DESIGN

Applications of VS-626VM3 Drives must be designed to fit the load machine and characteristics and configuration of the system. Use the following examples for reference. For wiring specifications and explanations of control signals, see the Explanation of Specifications, Par. 5.7 and 5.8.

8.1 SINGLE-MOTOR OPERATION BY SPEED CONTROL WITH THE DIGITAL OPERATOR

The inverter can be operated as single-motor drive using the digital operator provided as a standard. Start, stop, and home position control by the motor encoder are available. This configuration is convenient for test run. The inverter can be operated after connecting the main circuit and wiring the motor encoder as shown in Fig. 8.1.

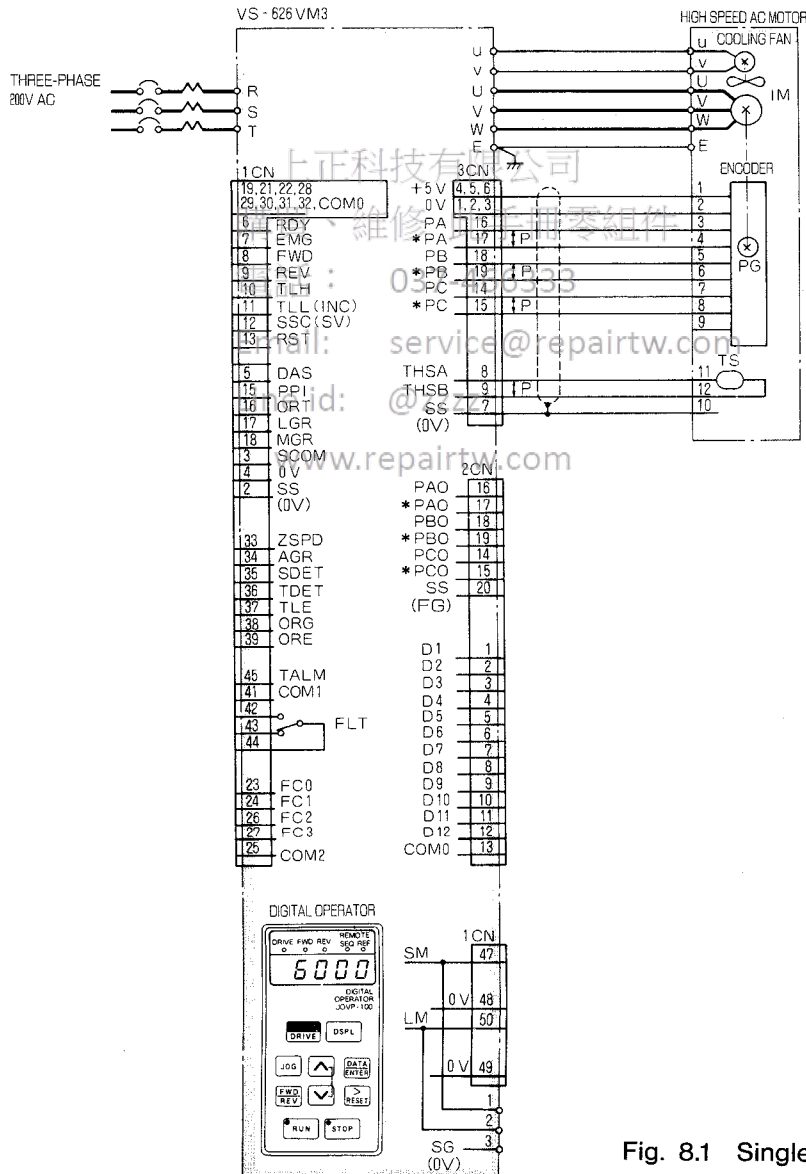

Fig. 8.1 Single-Motor Operation with Digital Operator

8.2 SPEED CONTROL WITH NC

The most typical use of VS-626VM3 is to drive the spindles of machine tools. Forward-reverse rotation and other sequence input signals, and zero-speed, speed-agreed, and other output signals are connected to the I/O module of the sequencer. Speed reference is connected to the axis control module of the CPU. Fig. 8.3 is a basic connection example.

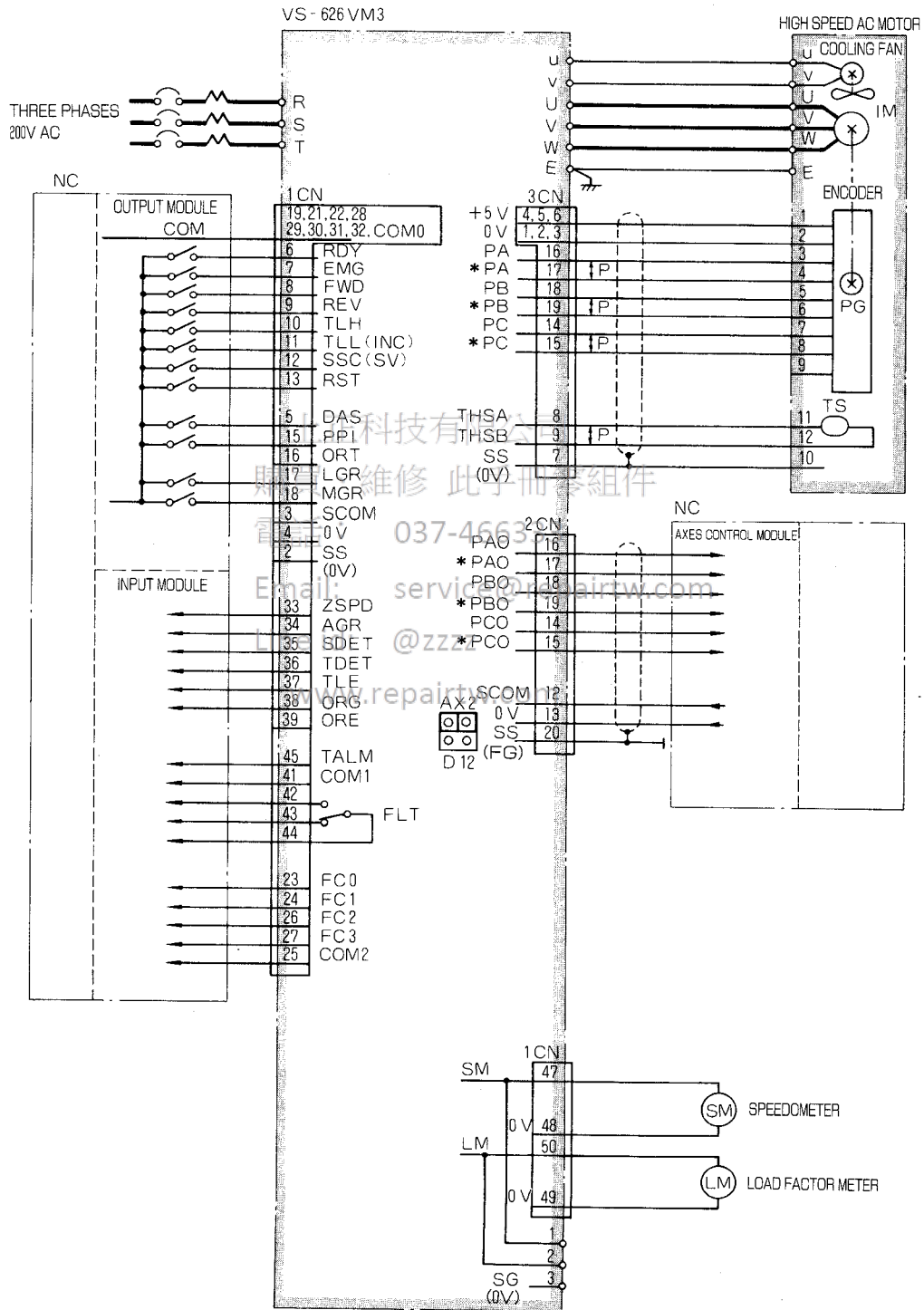

Fig. 8.3 Operation with NC

8.3 MULTI-STAGE SPEED CONTROL WITH PC

Multi-stage speed operation up to 8 stages is available by changing the setting of digital speed reference and using the internal speed setting as shown in Fig. 8.4. This setting is convenient for a repetitive operation using speed patterns set up in advance, for example, with specialized drilling machines such as transfer machines. Internally setup speed reference undergoes no noise interference or speed reference offset.

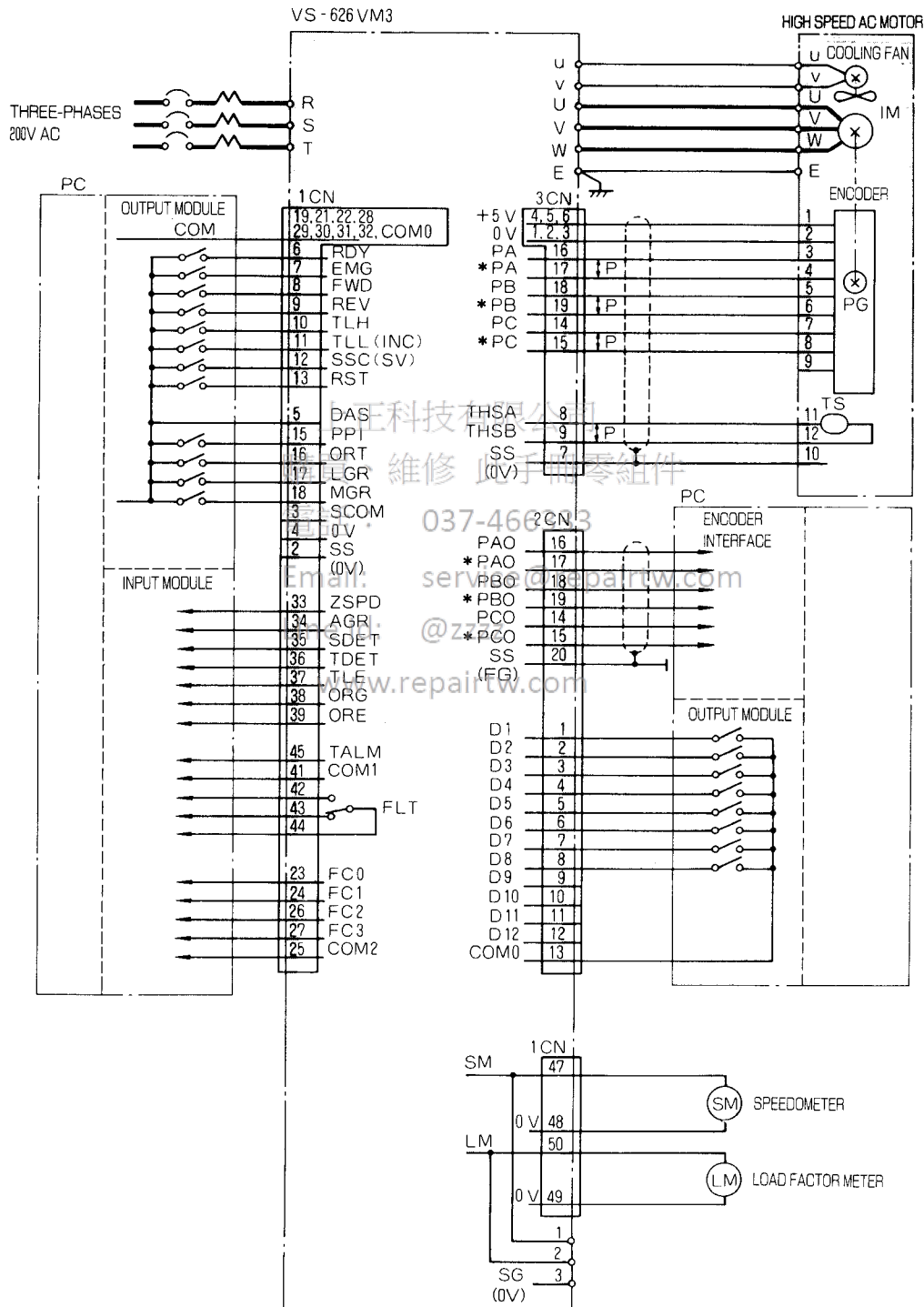
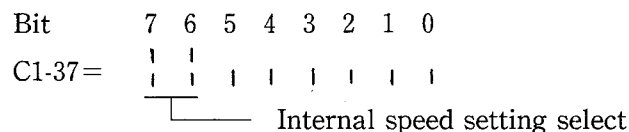

Fig. 8.4 Multistage Speed Operation with Internal Speed Setting

To use multi-stage speed control, select internal speed setting by setting bits 7 and 6 of control constant C1-37 (SEL2).



Setting “11” for the higher two bits of C1-37 makes internal speed setting valid, enabling multi-stage speed operation. Standard setting is “11” because digital speed reference is usually coded in 12-bit binary signals. Set internal speeds expressed as a percent of rated speed setting C1-26 (S100) for control constants C1-40 to C1-48. Table 8.2 lists the corresponding control constants of internal speed setting and pin numbers of 2CN:

Table 8.2 Internal Speed Setting Control Constants

Control Constants	Abbr.	Name	2CH Input
C1-41	SPD1	Internal speed 1	D1
C1-42	SPD2	Internal speed 2	D2
C1-43	SPD3	Internal speed 3	D3
C1-44	SPD4	Internal speed 4	D4
C1-45	SPD5	Internal speed 5	D5
C1-46	SPD6	Internal speed 6	D6
C1-47	SPD7	Internal speed 7	D7
C1-48	SPD8	Internal speed 8	D8

www.repairtw.com

<Notes on internal speeds>

- (1) If more than one set speed select signal (from D1 to D8) is connected simultaneously, the lowest speed setting number is valid.
- (2) If all set speed select signals are disconnected (open), it is assumed that speed reference 0 has been set.
- (3) Speed reference set values (C1-41 to C1-48) cannot be changed during operation.

8.4 WIDE RANGE CONSTANT OUTPUT BY WINDING SELECTION

Motor winding selection control is effective to extend constant output control range for driving the spindle of a milling machine. This method requires winding selection signals added to speed reference and signals for forward and reverse rotation, as shown in Fig. 8.5. To select motor windings, a specialized magnetic contactor having transfer contacts that can be directly driven by the inverter is used.

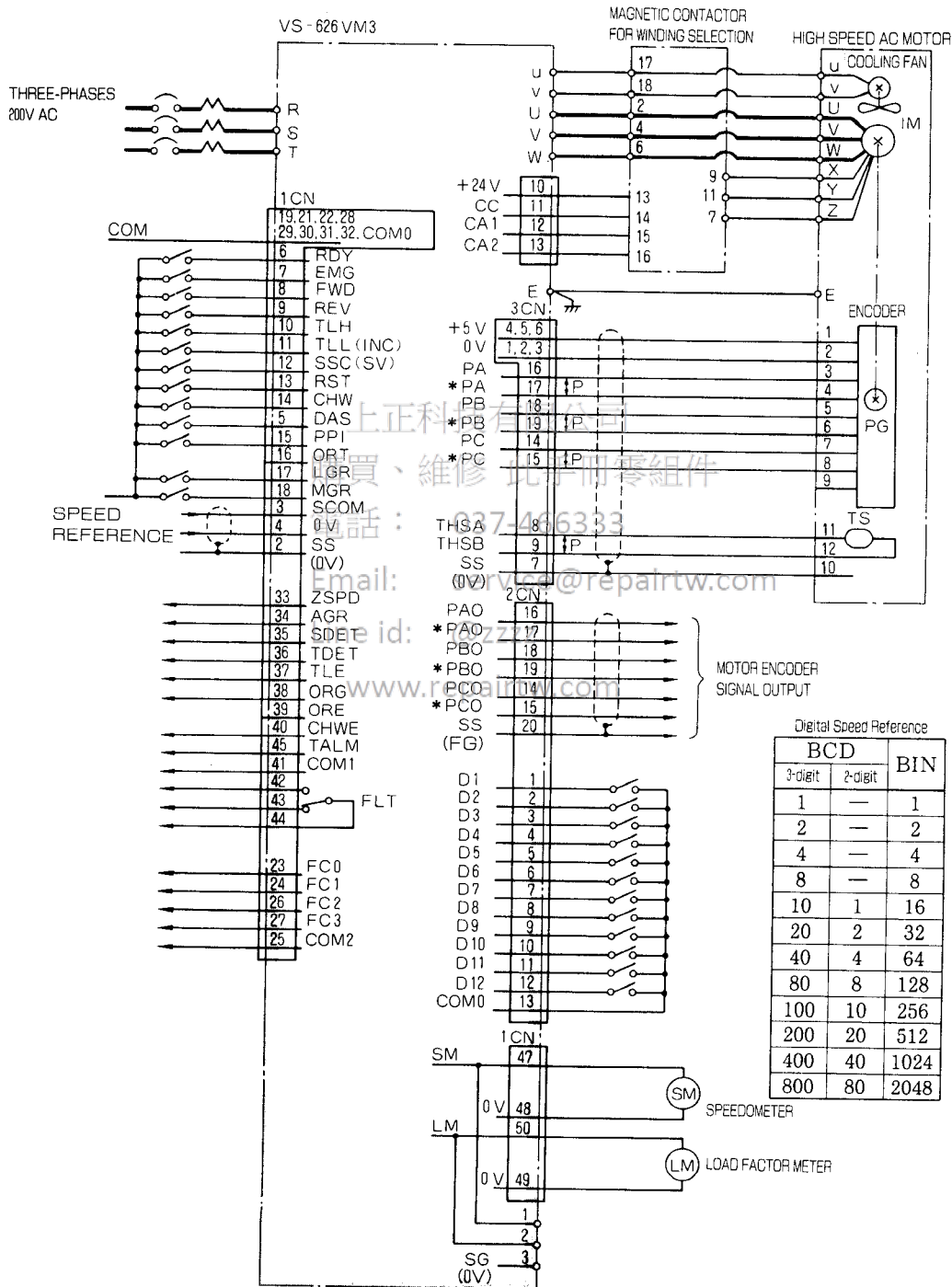

Fig. 8.5 Wide Range Constant Output by Winding Selection

8.4.1 Motor Characteristics

As shown in Fig. 8.6, a winding selection motor having a constant output range of 1:12 has a constant output range of 1:4 for both the low-speed winding and high-speed winding. This is expressed as follows:

$$\frac{S_{BH}}{S_{BL}} = \frac{S_{MH}}{S_{ML}} = 4$$

For optimum motor characteristics, the basic speed ratio and maximum speed ratio are determined as follows:

$$\frac{S_{ML}}{S_{BL}} = \frac{S_{MH}}{S_{BH}} = 3$$

Therefore, both the low-speed and high-speed windings generate rated output at speeds from S_{BH} to S_{ML} . The winding must be selected within this range.

(When the same output is generated by the low-speed and high-speed windings at a speed between S_{BH} to S_{ML} , the load meter indications may have an error of about $\pm 10\%$.)

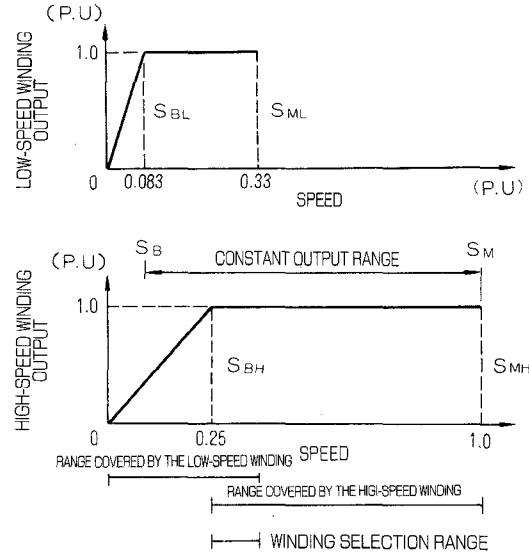

⚠ - Precaution
Do not use Low-speed winding at speeds over S_{ML} , which are not covered.

購買、維修 此手冊零組件

Fig. 8.6 Motor Output Characteristics

8.4.2 Winding Selection Operation: 037-466333

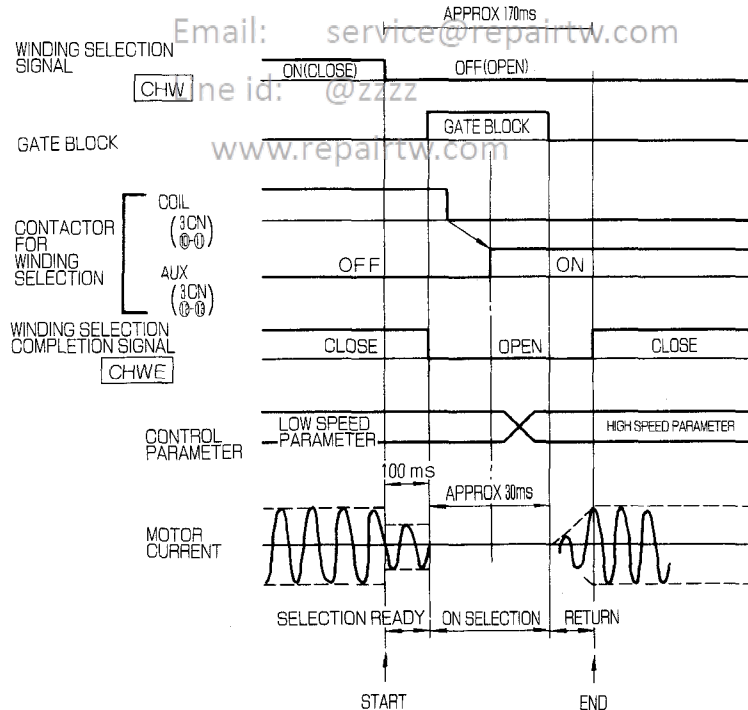

Note: Auxiliary contacts of magnetic contactor for winding selection type (3CN⑩-⑪) can be checked by control signal V1-09. CHWA LED of V1-09 goes ON when the auxiliary contacts are closed.

Fig. 8.7 Winding Selection Time Chart

8.4.3 Winding Selection Procedures

Three methods of winding selection procedures are described below. Refer to these ways when designing a sequence circuit of winding of change.

(1) M-code method

In case of spindle drive of machine tool, winding can be selected by using M-code. M41 is a low speed winding and M42 is a high speed winding. Flow chart is shown in Fig. 8.8 and time chart is shown in Fig. 8.9.

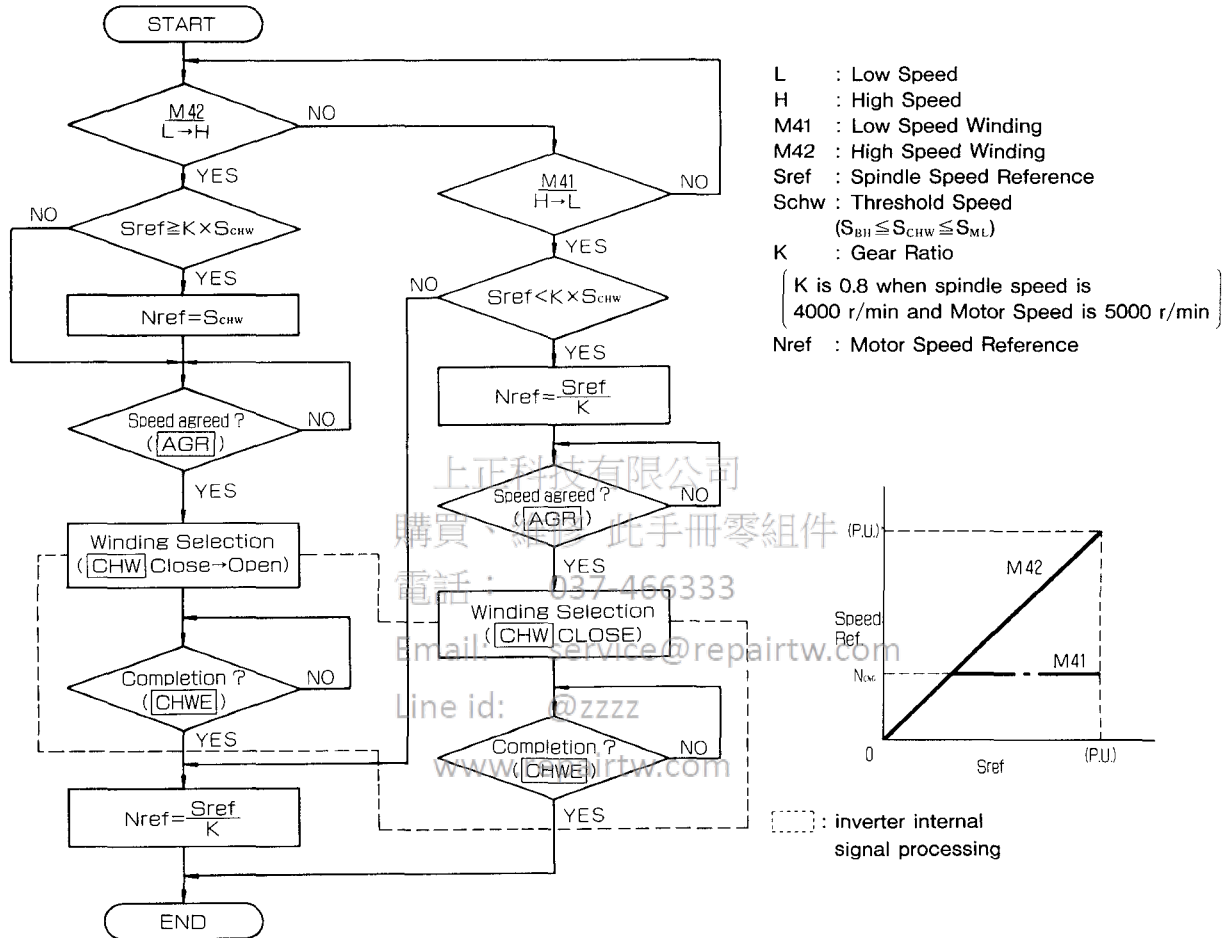

Fig. 8.8 Flow Chart

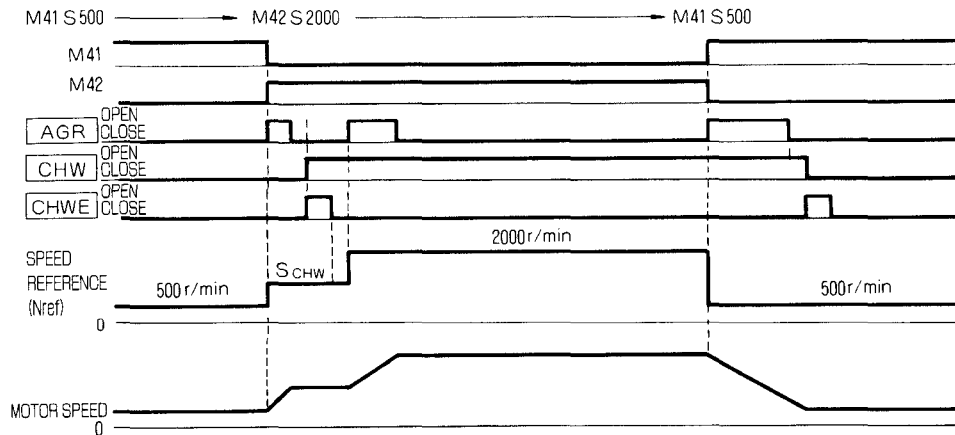
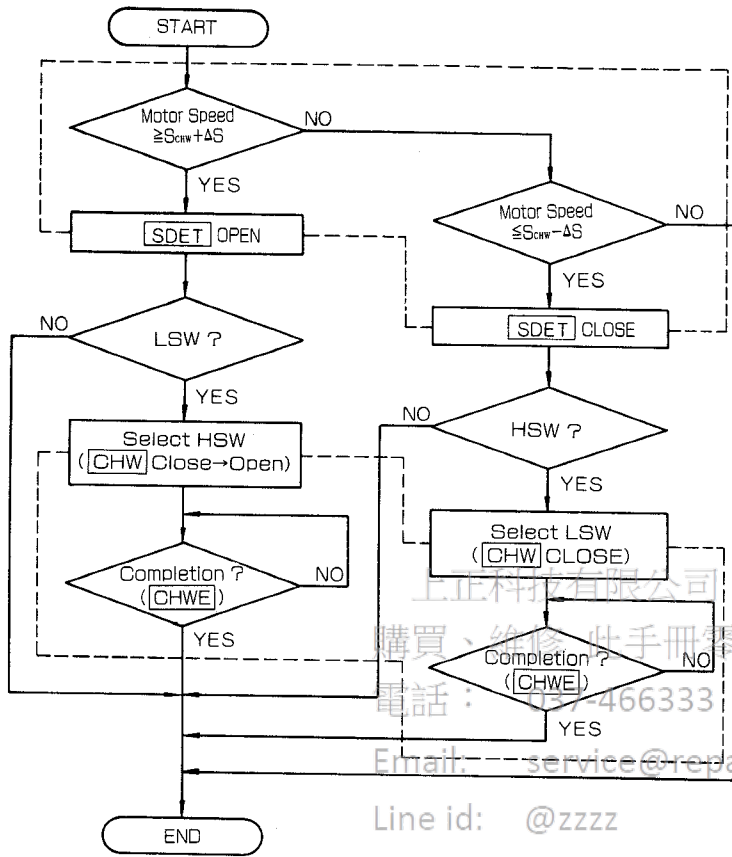

Fig. 8.9 Time Chart

(2) Auto winding selection method

Motor winding is automatically selected by using a speed detect signal [SDET] and watching the actual motor speed. Flow chart is shown in Fig. 8.10 and timing chart in Fig. 8.11.



LSW : Low Speed Winding
 HSW : High Speed Winding
 S_{CHW} : Threshold Speed
 { Set C1-21 (SD_{LVL}) of Control Parameter }
 ΔS : Band width of N_{CNG}
 { Set C1-22 (SD_{HYS}) of Control Parameter }

Setting value of C1-21 and C1-22 under Fig. are calculated as below.

$$S_{CHW} - \Delta S \geq S_{BH}$$

$$S_{CHW} + \Delta S \leq S_{BH}$$

$$C1-21 = \frac{S_{CHW}}{S_{100}(C1-26)} \times 100 (\%)$$

$$C1-22 = \frac{\Delta S}{S_{100}(C1-26)} \times 100 (\%)$$

(ΔS is from 100 through 200r/min)

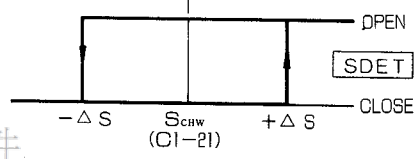

⋯ : Inverter internal signal processing

Fig. 8.10 Flow Chart

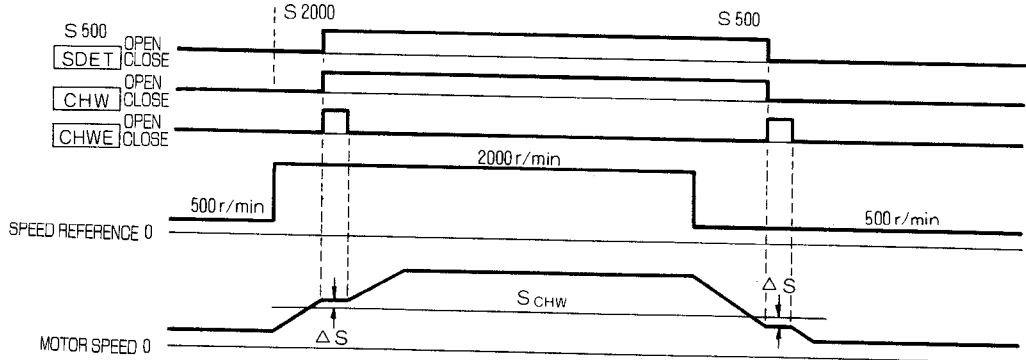

Fig. 8.11 Time Chart

(3) Automatic winding selection method (Cont'd)

Speed reference and actual motor speed are recognized from the speed reference and inverter speed detection signals **SDET** ; whether high-speed or low-speed winding should be used is determined according to select windings. The windings are selected according to Table 8.3. Compared to the selection method using only the speed detection signal, the magnetic contactor needs to be selected less frequently although signal processing is increased.

Fig. 8.12 is the flow chart. Fig. 8.13 is the time chart.

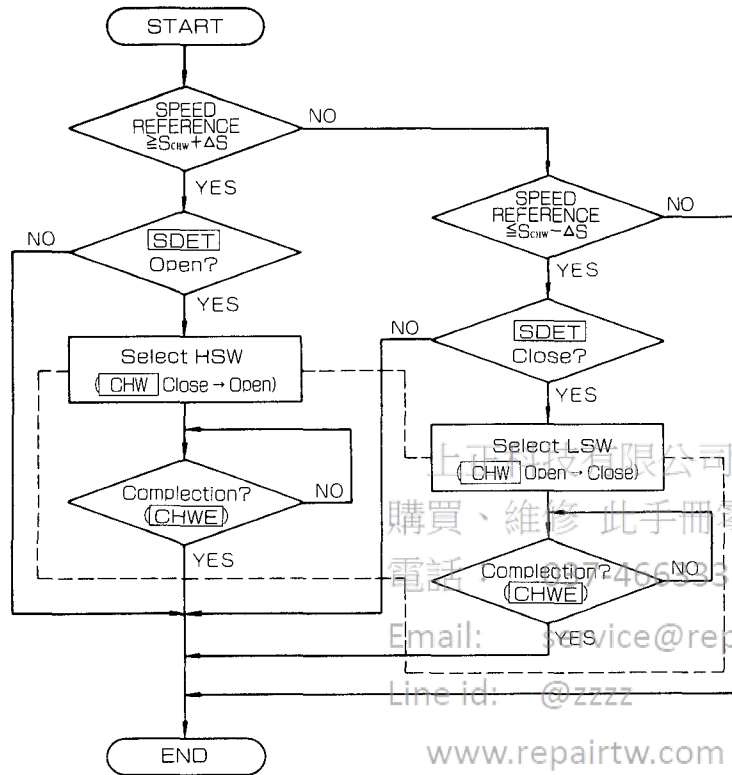

Table 8.3 Winding Selection Conditions

Speed reference	Speed reference	
	$\ge S_{CHW} - \Delta S$	$\le S_{CHW} + \Delta S$
Speed $\ge S_{CHW} - \Delta S$ (SDET Open)	Select high-speed winding.	Do not select winding.
Speed $\le S_{CHW} + \Delta S$ (SDET Close)	Do not select winding.	Select low-speed winding.

Set S_{CHW} , the check level of speed reference of the higher controller, for C1-21 (SD_{LVL}), which is the inverter speed detection signal level. Also set ΔS , the hysteresis level of the higher controller for C1-22 (SD_{HYS}), which is the inverter speed detection signal detection width.

⋯⋯: Inverter internal signal processing

Fig. 8.12 Flow Chart

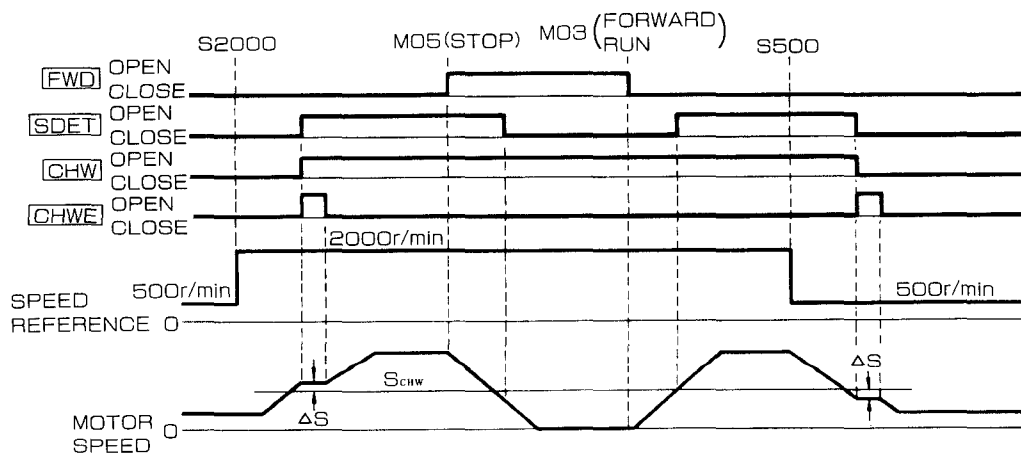

Fig. 8.13 Time Chart

8.4.4 Notes on Winding Selection Control

- If the magnetic contactor for motor winding selection is damaged or the signal leads are disconnected, the spindle stops and operation program does not proceed.
Check time and output alarm signal by using motor winding selection signal and motor winding selection completion signal to inform worker of this condition, recognizing winding selection failure (code: F-000), and stops operation.
- For automatic winding selection by motor speed detection, the magnetic contactor is activated frequently because windings are selected every time the actual speed crosses the selection speed S_{CHW} .
- When automatic winding selection is applied for driving the spindle of a lathe, windings are selected even during cutting if selection speed is reached. As shown in Fig. 8.14, the cut surface becomes rather more rough than usual if windings are selected during rough cutting. The difference is lessened as cutting advances to finishing. The following data prove practical benefits; however, checking the precision of cut surfaces if necessary.



上正科技有限公司
 購買維修此系列零件
 電話：037-466333
 Email: service@repairtw.com
 Line id: @zzzz
 www.repairtw.com

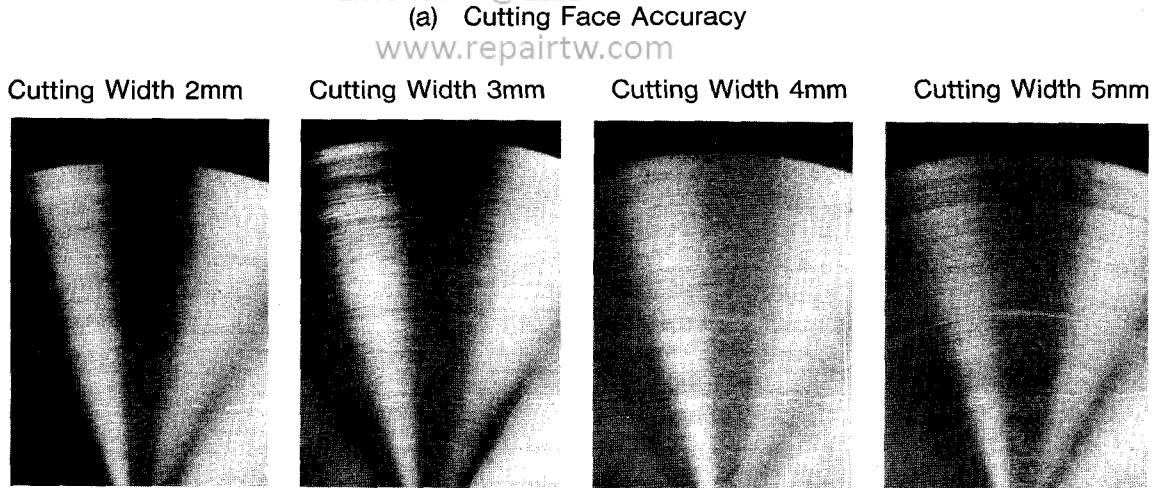

(b) Cutting Face State

- Test conditions
- Workpiece : S45C ($\phi 100$ rounded bar)
 - Bite : Super hard bite
 - Cutting speed : 150m/min
 - Feeding : 0.2mm/rev

Fig. 8.14 Face Accuracy Data at End Face Cutting by Lathe

8.5 ARBITRARY POSITION STOP CONTROL BY MOTOR ENCODER

When the spindle and the load axis are connected at transmission rate of 1 : 1, one rotation (angle) of the axis is divided into 4096 (at a resolution of 0.088°) by using the motor encoder signal and the positioning is commanded by stop angle command either in 12-bit binaries or 3-digit BCDs.

As shown in Fig. 8.15, this control requires a positioning reference and orientation signals, adding to speed reference, forward-reverse run and other signals.

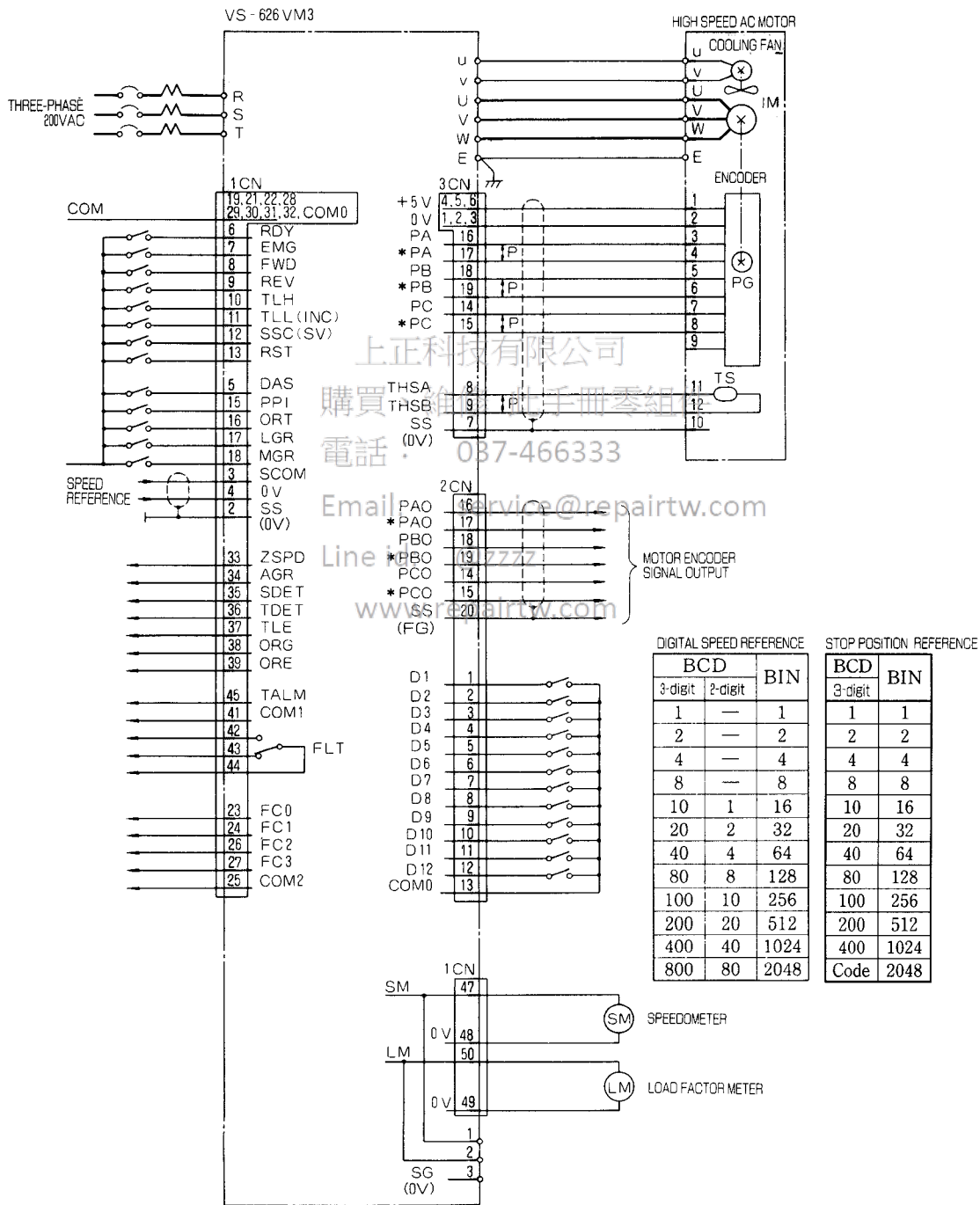

Fig. 8.15 Arbitrary Position Stop Control by Motor Encoder

- ⚠ - **Precaution for Orientation Control**

If the orientation function is to be used under the following conditions, adjust the machine and adjust parameters before starting.

- (1) When the orientation function is to be used for the first time after VS-626 VM3 was connected to the driven machine.
- (2) After exchanging the motor or the encoder.
- (3) After altering wiring between equipment.

For details about tuning, see the adjustment procedure.

The following two types of arbitrary positioning:

- (1) Absolute positioning
- (2) Incremental positioning

They are explained below.

(1) **Absolute positioning**

Absolute positioning is used to perform positioning at the specified stop position with the spindle zero point as reference. Therefore, when the specified stop position is "0", the spindle stops at the spindle zero point; when it is "90", the spindle stops at 90° after proceeding in the CW direction.

When the orientation signal is input during rotation (or stopping), the spindle speed decelerates or accelerates to the set orientation speed. After the set speed is reached, the encoder phase C signal is checked. Then the axis stops at the position specified by the servo loop, and at the same time, it outputs the orientation completion signal (ORE).

Since the servo loop keeps operating even after completion of orientation unless the orientation completion signal is turned off, the spindle hardly strays away from the positioning point even if external force is applied to the spindle.

Fig 8.16 is the time chart of absolute positioning.

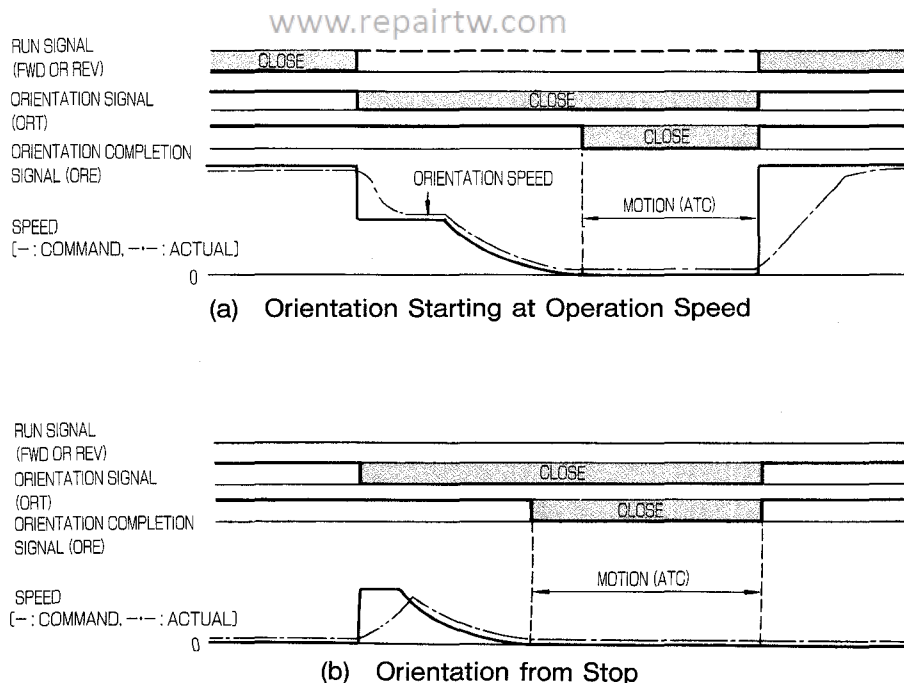

Fig. 8.16 Time Chart of Absolute Positioning

(2) Incremental positioning

Incremental positioning is used to perform positioning at a new stop position which is determined by adding the specified rotation moving amount (angle) to the current stop position.

By inputting the incremental signal and inputting the orientation signal again after completion of absolute positioning, the spindle stops at the new stop position, and at the same time, it outputs the completion signal.

In this mode, each time the orientation signal is input, the spindle proceeds by the specified rotation moving amount.

Fig 8.17 shows the time chart of the incremental positioning operation.

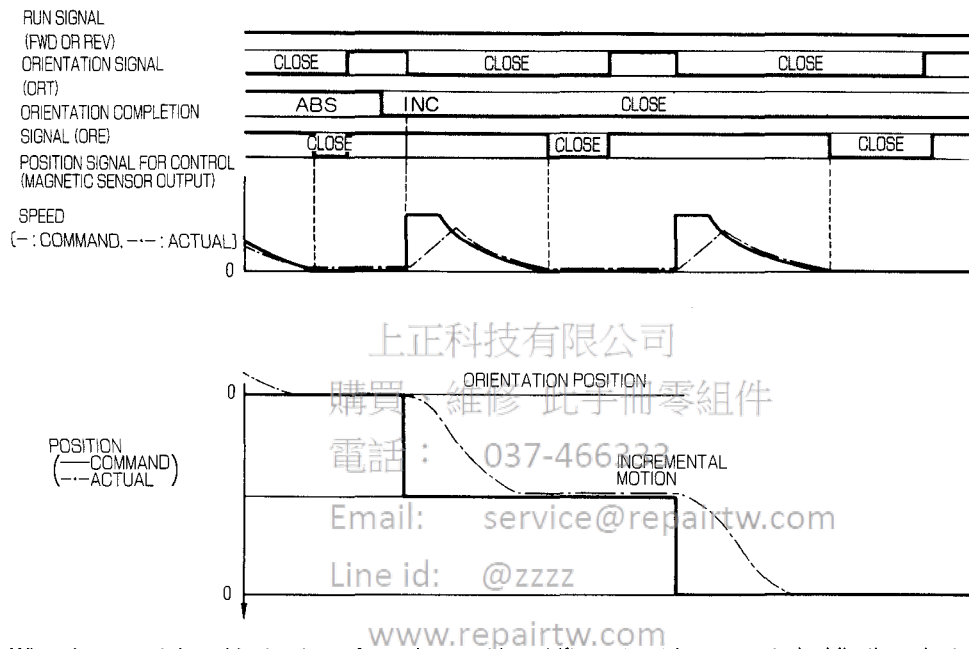

上正科技有限公司
 購買 維修 此等零件
 電話: 037-466333
 Email: service@repairtw.com
 Line id: @zzzz
 www.repairtw.com

Note: When incremental positioning is performed, a position shift must not be generated while the orientation signal is turned off.
 If a shift occurs, the stop positioning accuracy may not be obtained.

Fig. 8.17 Incremental Positioning

Select the stop position reference by control constant C1-36 (SEL1) for arbitrary position stop control.

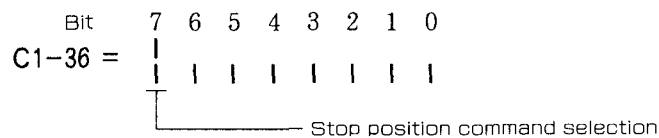

When “|” is set to Cn-36 bit 7, the stop position reference becomes effective and arbitrary positioning is enabled at orientation control. Since it is normally used as digital speed reference, the standard setting is “|”. When bit 7 is set to “1”, constant positioning control is performed.

8.6 STOP AT HOME/ARBITRARY POSITION BY MAGNETIC SENSOR

The spindle can be stopped at a specific angle to the motor shaft by detecting the position of a magneto mounted on the rotor of the spindle by a magnetic sensor mounted on the stator. As shown in Fig. 8.18, this control requires positioning reference and orientation signals, a magneto, a magnetic sensor, and magnetic sensor orientation card adding to speed reference, forward-reverse run and other signals. Furthermore, after positioning by a magnetic sensor, optional position stop control can be obtained from the spindle motor encoder. In this case, stop position control reference is needed.

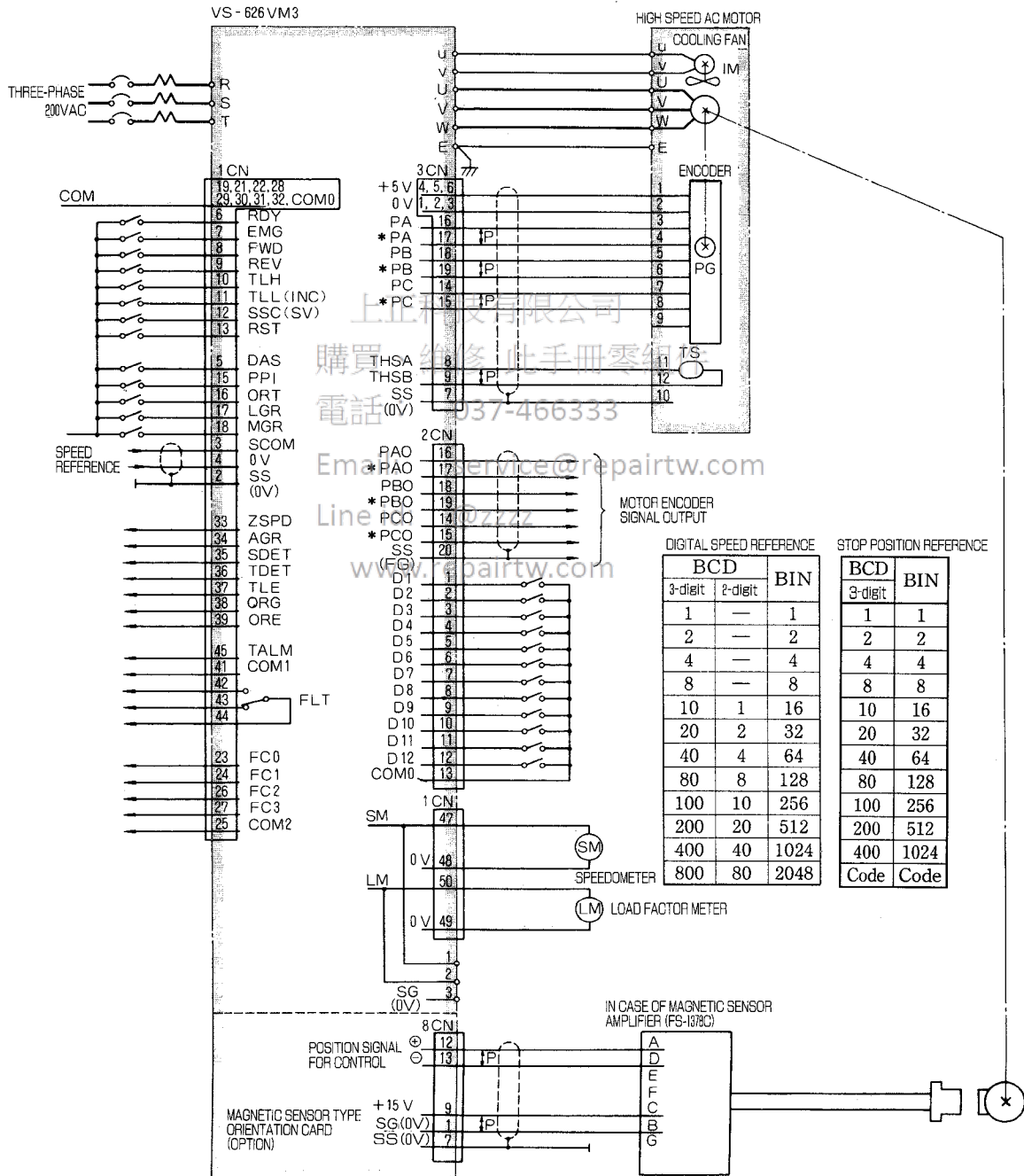

Fig. 8.18 Stop at Home/Arbitrary Position by Magnetic Sensor

-  - Precaution for orientation control

If the orientation function is to be used under the following conditions, adjust the machine and adjust parameters before starting.

- (1) When the orientation function is to be used for the first time after 626 VM3 was connected to the load machine.
 - (2) After exchanging the motor, magnet, or magnetic sensor.
 - (3) After altering wiring between equipment.
- For details about tuning, see the adjustment procedure.

Home position stop operation with a magnetic sensor is explained in the following.

(1) Stop at Home Position by Magnetic Sensor

If an orientation signal is input during rotation (or when the machine is stopped), the spindle speed is immediately accelerated (or decelerated) to the set orientation speed. After the set speed is reached and the magneto on the spindle passes by the stop position, the servo loop uses a motor encoder signal to rotate the spindle until the centers of the magneto and the magnetic sensor match, and uses the magnetic sensor signal to stop the spindle at the home position. At the same time, an orientation completion signal (ORE) is output. After orientation is completed, the servo loop operates until the orientation signal is turned OFF. Thus, the spindle is not easily moved from the home position even when external force is applied in the direction of rotation.

Fig. 8.19 shows the time chart of positioning.

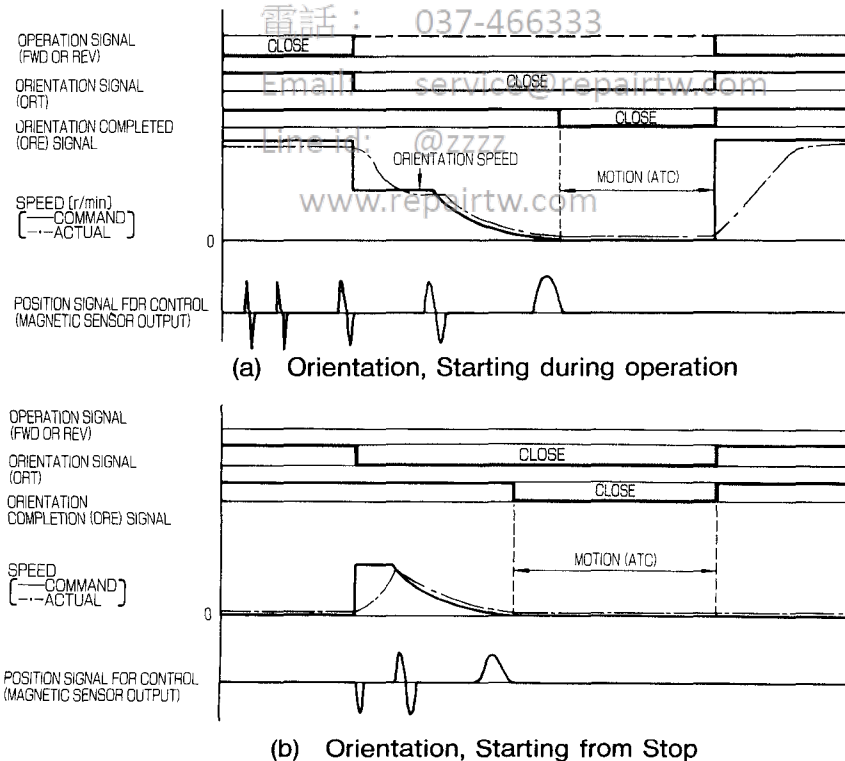

Note: If slip does not occur in transmission mechanism and parameters are set up properly, the servo loop stops the shaft smoothly.

Fig. 8.19 Positioning Operation

(2) Arbitrary positioning control by incremental positioning

Incremental positioning is used to perform positioning at a new stop position which is determined by adding the specified rotation moving amount (angle) to the current stop position.

By inputting the incremental signal and inputting the orientation signal again after completion of absolute positioning, the spindle stops at the new stop position, and at the same time, it outputs the completion signal.

In this mode, each time the orientation signal is input, the spindle proceeds by the specified rotation moving amount.

Fig. 8.20 shows the time chart of the incremental positioning operation.

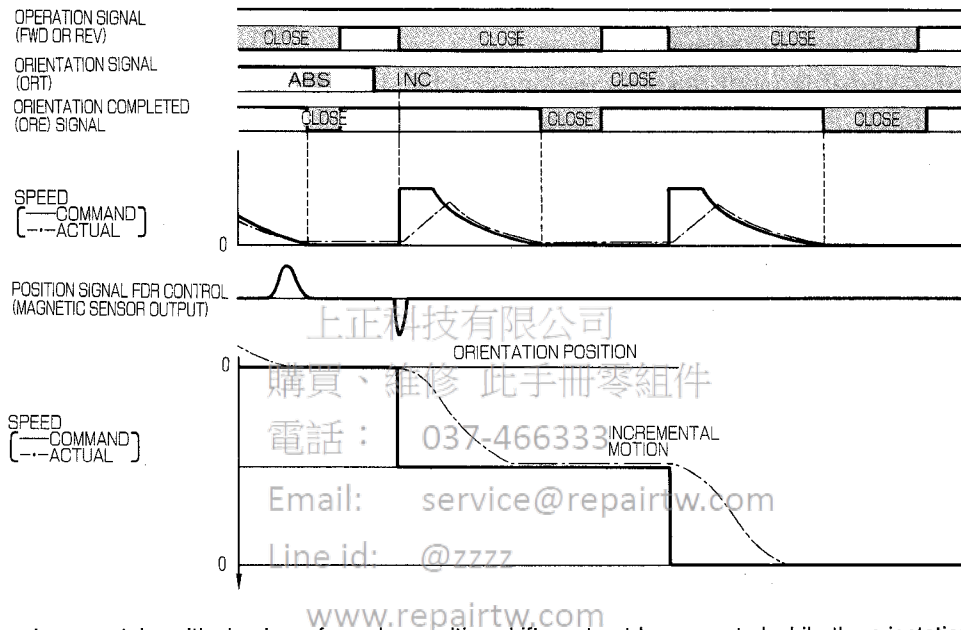

Note: When incremental positioning is performed, a position shift must not be generated while the orientation signal is turned off.
If a shift occurs, the stop positioning accuracy may not be obtained.

Fig. 8.20 Incremental Positioning

Select the stop position reference by control constant C1-36 (SEL1) for arbitrary position stop control.

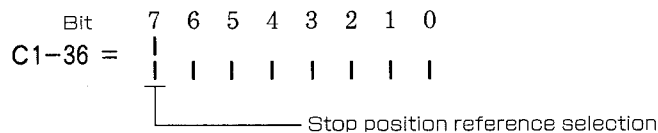

When “|” is set to Cn-36 bit 7, the stop position reference becomes effective and arbitrary positioning is enabled at orientation control. Since it is normally used as digital speed reference, the standard setting is “|”. When bit 7 is set to “|”, constant positioning control is performed.

8.7 STOP AT ARBITRARY POSITION BY SPINDLE ENCODER

When the spindle encoder is connected to the load axis (spindle) at a ratio of 1:1, for example, in a lathe, the spindle can be positioned using signals from the encoder and dividing one rotation into 4096 (at a resolution of 0.088°). Positioning is commanded by origin offset either in 12-bit binaries or 3-digit BCDs. As shown in Fig. 8.21, this control requires position reference orientation signals, origin offset, and encoder orientation card adding to speed reference, forward/reverse run and other signals.

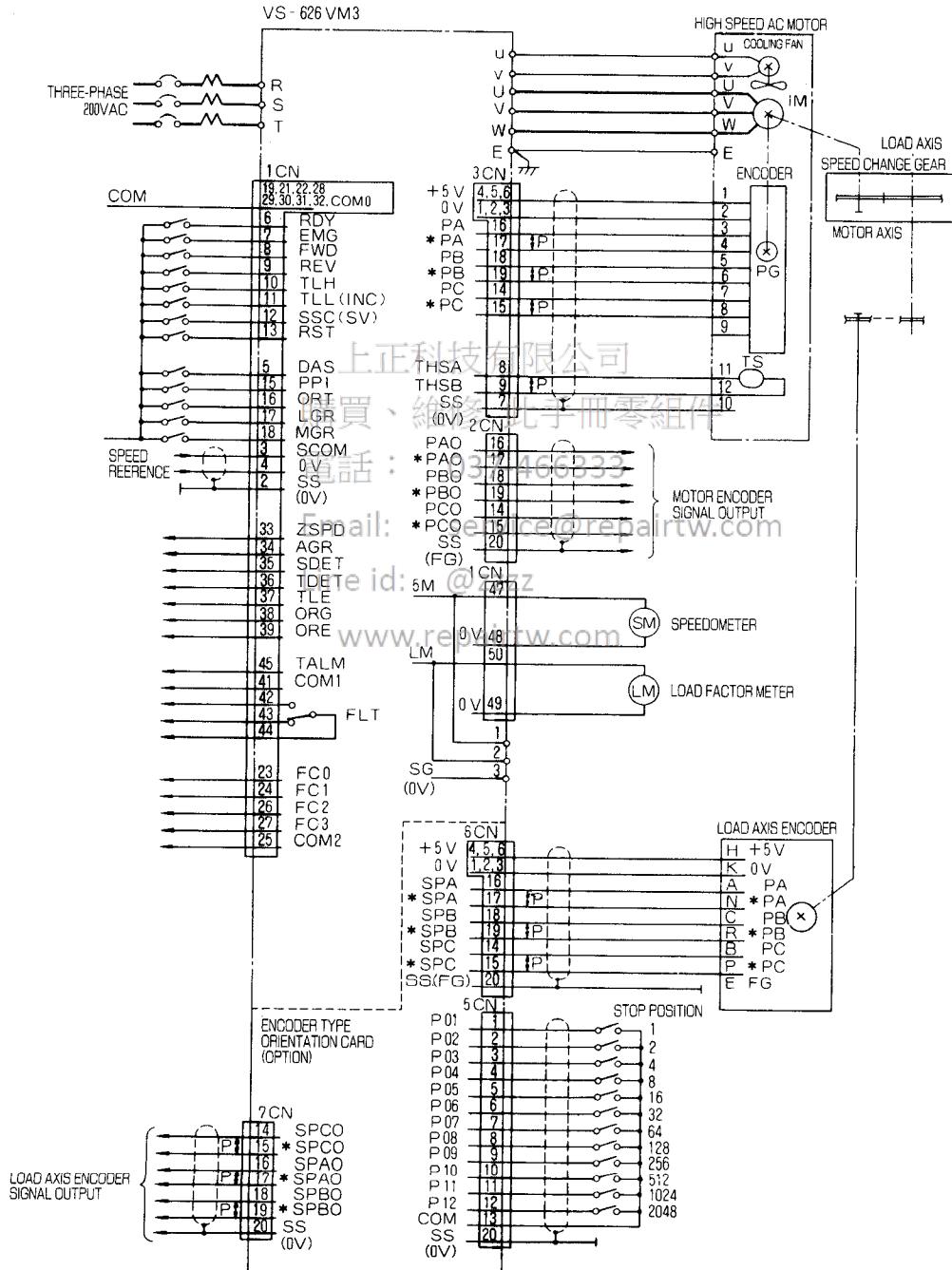

Fig. 8.21 Stop at Arbitrary Position by Spindle Encoder

-  - Precaution for orientation control

If the orientation function is to be used under the following conditions, adjust the machine and adjust parameters before starting.

- (1) When the orientation function is to be used for the first time after VS-626VM3 was connected to the load machine.
- (2) After exchanging the motor or the encoder.
- (3) After altering wiring between equipment.

For details about tuning, see the adjustment procedure.

There are two ways to find a specified position:

- (1) Absolute positioning
- (2) Incremental positioning

They are explained in the following.

8.7.1 Absolute Positioning

Absolute positioning determines the stop position of the spindle in reference to the origin of the spindle. If "0°" is specified for the stop position, the spindle stops at the home position. If "90°" is specified, the axis stops at a position 90° clockwise from the home position.

If an orientation signal is input during rotation (or when the machine is stopped), the spindle speed is immediately accelerated (or decelerated) to the set orientation speed. After the set speed is reached, phase-C signal of the encoder is checked, then the spindle stops at a position specified by the servo loop. At the same time, an orientation completion signal (ORE) is output.

After orientation is completed, the servo loop operates until the orientation signal is turned OFF. Thus, the spindle is not easily moved from the home position even when external force is applied in the direction of rotation.

Fig. 8.22 shows the timing chart of absolute positioning.

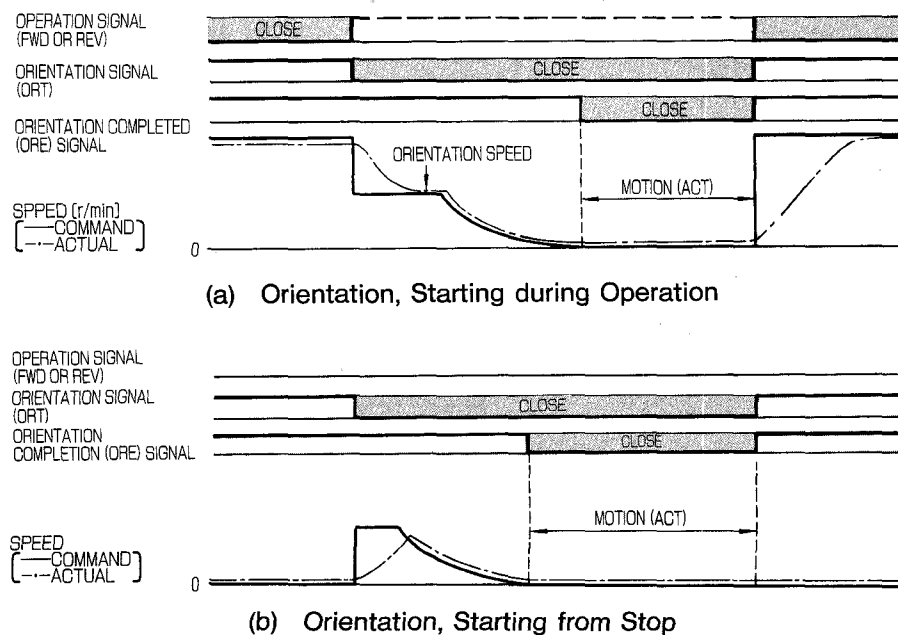

Fig. 8.22 Absolute Positioning Operation

8.7.2 Incremental Positioning

Incremental positioning determines the stop position of the spindle by adding a specified rotation displacement (in degrees) to the current stop position.

If an incremental signal is input after absolute positioning is completed, and previous orientation signal is input again, and the servo loop moves the spindle to the new stop position. At the same time, a completion signal is output.

In this mode of positioning, the load axis is moved by a specified rotation displacement every time an orientation signal is input.

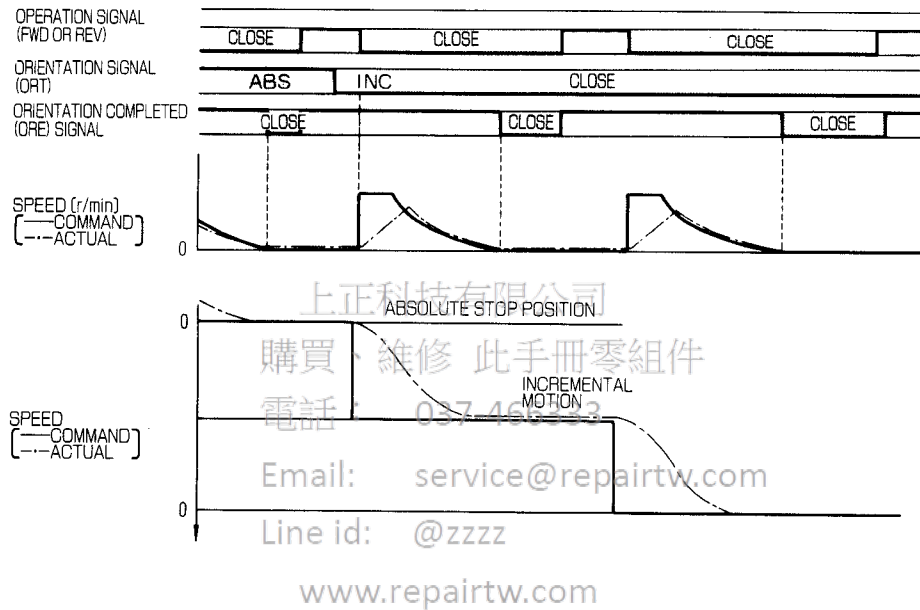

Note: To use incremental positioning, be careful not to move the spindle while the orientation signal is OFF. Otherwise, stop position precision is reduced.

Fig. 8.23 Incremental Positioning

NOTE

上正科技有限公司
購買、維修 此手冊零組件
電話： 037-466333
Email: service@repairtw.com
Line id: @zzzz
www.repairtw.com

Startup Manual



— — — — — Precaution on Trial Run — — — — —

VS-626VM Drives convert electric energy into mechanical energy. The drives process a large quantity of energy. Become thoroughly familiar with the functionality, characteristics, and operations of the motor and the inverter. Before starting trial run.

This manual provides the above information together with start-up and adjustment procedures. Read this manual thoroughly for safe operation to prevent injury or damage to the equipment.

9. RECEIVING INSPECTION AND PRE-STORAGE CHECK	140	13.2.6 Digital Operator Operation Mode	160
9.1 CHECK WHEN UNPACKING ..	140	13.3 OPERATION STATUS DISPLAY FUNCTION	162
9.1.1 Motor Nameplate	140	13.4 CONTROL CONSTANTS	165
9.1.2 Inverter Nameplate	141	13.5 PROTECTIVE FUNCTION DISPLAY	175
9.2 NOTES ON STORAGE	142	14. DRY RUN	177
10. INVERTER PARTS NAMES AND FUNCTIONS	143	14.1 CHECK AFTER TURNING ON POWER	177
11. MOUNTING AND WIRING	144	14.1.1 Checking the Motor	177
11.1 NOTES ON INSTALLATION OF THE MOTOR	144	14.1.2 Checking the Inverter	177
11.1.1 Installation Location	144	14.1.3 Checking Status Display	177
11.1.2 Installation Orientation	144	14.2 SETTING UP CONSTANTS ..	178
11.1.3 Connection to Load Machine	145	14.2.1 Soft Start Time Setup	178
11.2 NOTES ON INSTALLATION OF THE INVERTER	146	14.2.2 Load Meter Full-Scale	178
11.2.1 Installation Location	146	14.2.3 Zero-speed Detection Level	178
11.2.2 Installation Orientation	147	14.2.4 Speed Agree Width	179
11.3 CONNECTION	148	14.2.5 Speed Detection Level	179
11.4 NOTES ON CONNECTION	149	14.2.6 Torque Detection Level	179
12. PREPARATION BEFORE STARTING	152	14.2.7 External Operation Torque-Limiting Level	180
12.1 CHECK BEFORE TURNING ON POWER	152	14.2.8 Motor Code Selection	180
12.2 CHECKING POWER VOLTAGE	152	14.2.9 Rated Speed	180
12.3 SELECTION CONNECTOR SETUP FOR DIFFERENT SPEED REFERENCE INPUT METHODS	153	14.2.10 Transmission Ratio	180
13. OPERATION OF DIGITAL OPERATOR	154	14.2.11 Flux and Base Speed Ratio in Servo Mode	181
13.1 FUNCTIONS OF THE DIGITAL OPERATOR	154	14.2.12 Positioning Completion Detection Width and Positioning Completion Cancel Width	181
13.2 KEY OPERATIONS AND DISPLAY	156	14.2.13 Orientation Speed	182
13.2.1 Indication at Power-ON	157	14.2.14 Resolution of BCD Stop Position Reference	183
13.2.2 Switching Display Functions	157	14.3 OPERATION	183
13.2.3 Operation Status Display Mode	158	14.4 ADJUSTMENT PROCEDURE AND CONTROL CONSTANT SETUP ..	184
13.2.4 Control Constant Display Mode	159	14.4.1 Adjustment in Speed Control Mode	184
13.2.5 Protective Function Operation Display Mode	160	14.4.2 Adjustment in Encoder Orientation Control Mode	186
		14.4.3 Adjustment in Magnetic Sensor Orientation Control Mode	188

9. RECEIVING INSPECTION AND PRE-STORAGE CHECK

9.1 CHECK WHEN UNPACKING

Upon receipt of the inverter and the motor of VS-626VM3 Drives, unpack and check the following. Make sure that the motor and inverter are kept free from packing materials or fittings.

- (1) Check the type and specifications of the delivered product with the shipping documents.
- (2) Check optional equipment and spare parts.
- (3) Verify that a parameter list is provided.
- (4) Check for any damage during transit.

If there is any discrepancy or any condition such as damage, or the delivered equipment does not conform to listed specifications, contact your YASKAWA representative. Phone and fax numbers of YASKAWA representatives are listed on the back cover of this manual.

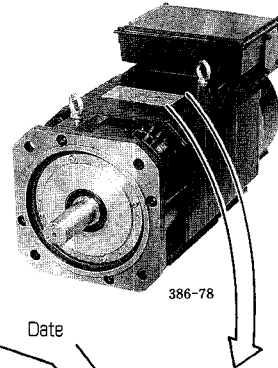

9.1.1 Motor Nameplate

Type	Rated Voltage	Insulation Class	Date
AC SPINDLE MOTOR			
TYPE UAASKA-08DZ1			DATE 1996.4
PHASE 3			POLES 4
			INS. F
Standard	RULE JIS C 4004	JP44 JCAOFA4S	VOLT MAX. 200 V
Rated Spec.	kWd: 7.5/5.5	RATING 30 MIN/CONT.	r/min 1500/8000
			AMP 46/37
Bearing No.	BRG NO.		
(Drive End/Opp. Drive End)	SER NO. S123456	-001	
Serial No.	YASKAWA ELECTRIC CORPORATION JAPAN		NB3871-1N
		Poles	

9.1.2 Inverter Nameplate

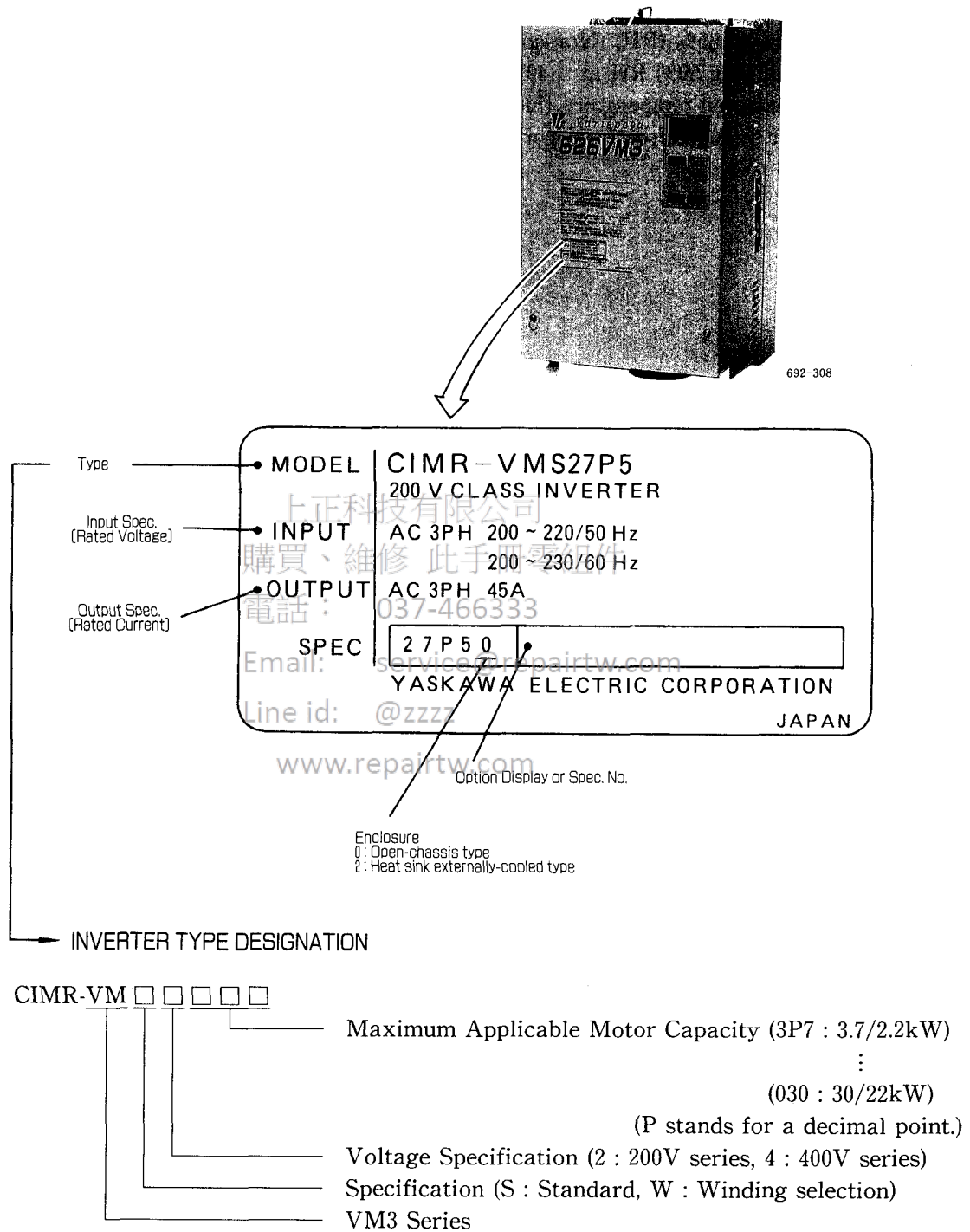

Fig. 9.2 Example of Inverter Nameplate

9.2 NOTES ON STORAGE

If the inverter and the motor are to be stored for a period of time, prepare the following conditions to keep the equipment in good order.

- (1) Temperature: 0°C to +60°C
- (2) Humidity: 5% to 95% (RH) (Non-condensing)
 - ★ - Air containing 50% RH at +40°C condenses when cooled to +28°C. Take special care if extreme temperature fluctuations exist/occur in the storage area.
- (3) Environment: Indoors free from corrosive gases , mist and dust

上正科技有限公司
購買、維修 此手冊零組件
電話： 037-466333
Email: service@repairtw.com
Line id: @zzzz
www.repairtw.com

10. INVERTER PARTS NAMES AND FUNCTIONS

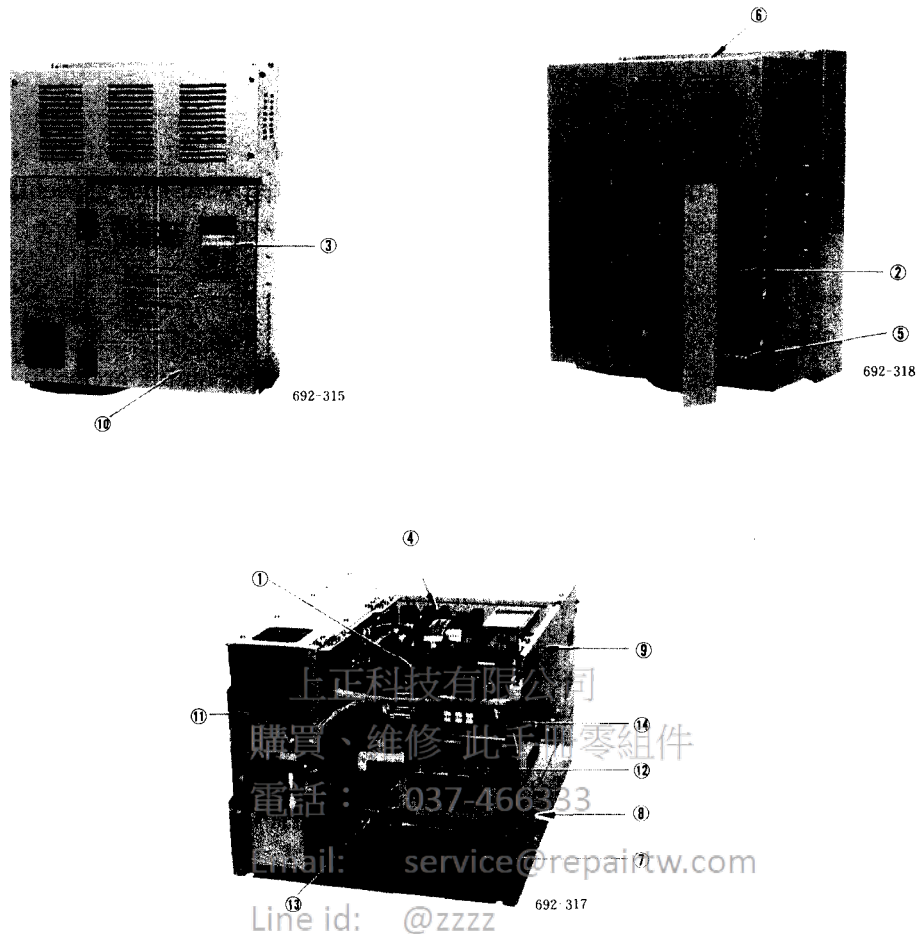

- ① Controller: Consists of Electronic circuits including the CPU that controls the inverter.
- ② Gate driver: Drives the IGBTs in the main circuit according to signals from the controller.
- ③ Digital operator: Monitors status of operation, displays and sets control constants.
- ④ DCP (control power source): Supplies control power to the controller and the encoder.
- ⑤ Power interface: This is the input circuit of control power and contains the control power fuse.
- ⑥ Cooling fan box: Contains the heat sink cooling fan.
- ⑦ Heat sink: This is the cooling medium for the main circuit IGBTs.
- ⑧ Air duct panel: This panel is used for mounting the inverter in the control panel, and also serves as the air duct.
- ⑨ PC board frame: The controller and option cards are mounted on this panel.
- ⑩ Faceplate: Protects PC boards including the controller.
- ⑪ Input terminals: These terminals connect to the commercial-current power source, and are identified as R, S, and T.
- ⑫ Output terminals: These terminals connect to the motor or electromagnetic contactor, and are identified as U, V, and W.
- ⑬ Ground Terminal: This is for the inverter grounding, and is identified as E.
- ⑭ Charge indicator: Indicates that the electrolytic capacitor in the main circuit is charged. Wait until this lamp goes OFF before touching the main circuit of the inverter.

Fig. 10.1 Construction of Inverter

11. MOUNTING AND WIRING

11.1 NOTES ON INSTALLATION OF THE MOTOR

Notes on installation of the motor

The flange surface and the output shaft of the motor are coated with rust preventives or grease. Clean the flange surface, output shaft, and keyways with thinner before installation.

11.1.1 Installation Location

- (1) Sufficient cooling air must be supplied to the cooling fan. The motor opposite drive end (where cooling air is exhausted) must be separated from machines by 100mm or more.
 - ★ - If supplied air is insufficient, motor thermal error protection may be activated even under loads within the rating.
- (2) The motor must be protected from water or oil splashes. Use a protective cover, if necessary.
 - ★ - Entry of water or used oil into the motor may deteriorate insulation and cause a ground fault.
- (3) The motor must be installed on a sturdy bed, base, or frame.
 - ★ - Adding to the motor weight, dynamic load is applied to the bed during operation, and vibration may occur.
 - ★ - Use a motor of an outside diameter of 250mm or below operating under vibration acceleration of 2.5G or less (Standard type : 22/18.5kW (30/25HP) or below ; Winding selection type : 11/7.5kW (15/10HP) or below).
For other large capacity models, contact your YASKAWA representative.
- (4) The motor must not be placed where there is excessive dust, iron particles or mist.
 - ★ - The motor core is cooled by air sent from the built-in fan. Accumulation of dust in the air duct reduces cooling capacity and the motor thermal error protection may be activated even under loads within the rating.

11.1.2 Installation Orientation

- (1) Flange-mounted type motors can be installed when the motor output shaft connected to the driven machine is perpendicular to vertically downward position.
 - ★ - When the output shaft is directed upward, excess force is applied to the motor bearing and the life may be shortened.
- (2) Foot-mounted motors must be mounted on the floor with the foot under the motor body.
 - ★ - If the motor is suspended upside down, excess force is applied to the foot and the life may be shortened.
- (3) To place the output shaft in a horizontal position, the terminal box must be on the upper side.
 - ★ - If the terminal box is on the side or bottom, dust easily enters from the air vent under the bracket on the driven machine side, leading to a possible malfunction.

11.1.3 Connection to Load Machine

(1) To connect directly, align the centers of the motor shaft and the load machine shaft, so that the two shafts form a straight line. Use a spline if necessary.

- ★ - If the centers of the shafts are misaligned, excessive twisting force is applied to both the motor shaft and load machine shaft, and the bearing may be damaged or worn out quickly.

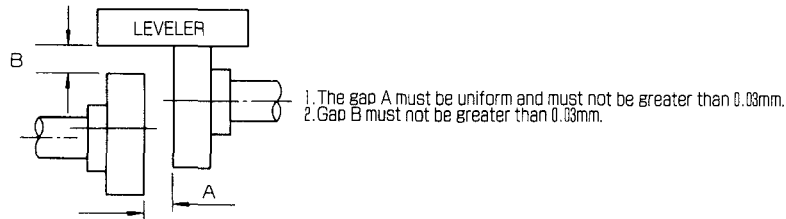

Fig. 11.1 Connection between the Motor and Load Machine

(2) For V-belt drive, lay the motor and spindle parallel to each other, and perpendicular to the line passing through the centers of both pulleys. Radial load applied to the shaft end of the motor output flange must not exceed the limit listed in Table 3.2.

- ★ - If the belt is not placed at an exact right angle, vibration may occur or the belt may slip. If an excess radial load is applied to the motor shaft, excess force is applied to the motor bearing and its life may be shortened.

(3) The arc of contact(ϕ) must be 140° or greater.

- ★ - If the arc of contact(ϕ) is smaller, the belt may slip.

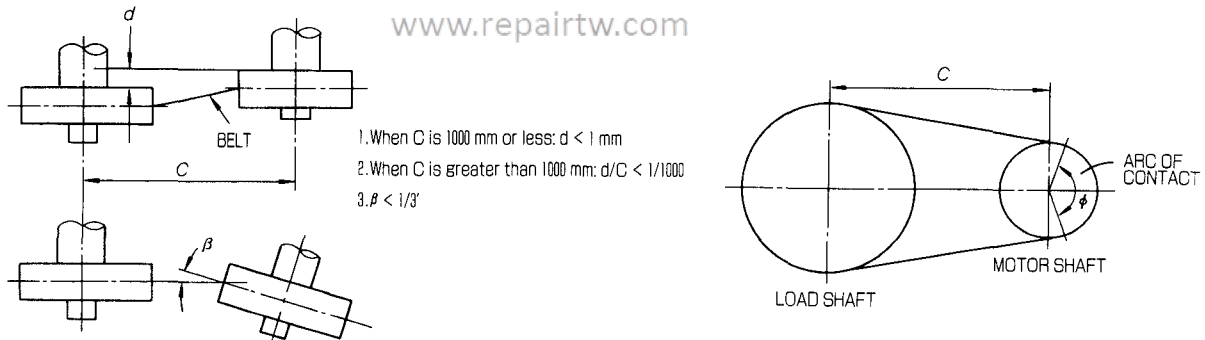

Fig. 11.2 Connecting a belt

(4) To use gears, lay the motor and machine shafts parallel to each other, and engage the shafts at the centers of the tooth surfaces.

- ★ - If the tooth surfaces are not engaged properly, gear noise occurs.

(5) To attach pulleys or gears to the motor output flange, they must be balanced well. The motor is in dynamic balance when a half-key having a half-thickness of the size shown in the dimension diagram (of the shaft) is attached.

- ★ - A slight unbalance may cause vibration during high-speed rotation.

11.2 NOTES ON INSTALLATION OF THE INVERTER

Notes on installation of the inverter

When carrying the inverter, handle with care so as not to damage it. Holding the face plate or PC board frame when carrying may damage the equipment.

11.2.1 Installation Location

- (1) The inverter must be kept free from water or oil splashes.
 - ★ - Entry of water or oil into the inverter may deteriorate insulation and cause a ground fault.
- (2) Avoid direct sunlight.
 - ★ - Radiant heat of the sun may raise the temperature in the inverter over the operating thermal range and life of electronic components may be significantly reduced.
- (3) Avoid corrosive gases and liquids. Avoid locations where dust or iron powder is abundant.
 - ★ - Corrosion by harmful gases or adhesion of dust may deteriorate insulation resistance and cause a ground fault.
- (4) The inverter houses the heat sink cooling fan at the rear. Leave 150 mm or greater clearance on the upper (exhaust) and lower (entry) sides of the fan to prevent cooling performance deterioration.
 - ★ - If air flow is obstructed and insufficient cooling air is supplied, a heat sink overheat error may occur even when the output is within the rating.
- (5) Although the control panel open-chassis type inverter is operable at 0°C to +55°C, air entering the heat sink must be 45°C or below. See Fig. 11.3.
 - ★ - If warmer air is input, heat dissipation from the heat sink is reduced and a heat sink overheat error may occur even when the output is within the rating.
- (6) For ease of periodical inspection and maintenance, leave space to open and close the PC board frame. Also make clearance of 30 mm or greater from each side panel of the inverter.
 - ★ - If the above clearances are not provided, proper inspection and maintenance will not be possible.

- (7) Place sealant at the unit mounting joint to prevent entry of dust.
- ★ - If no sealant is applied, water or iron powder may enter from the joint to deteriorate insulation and cause a ground fault.

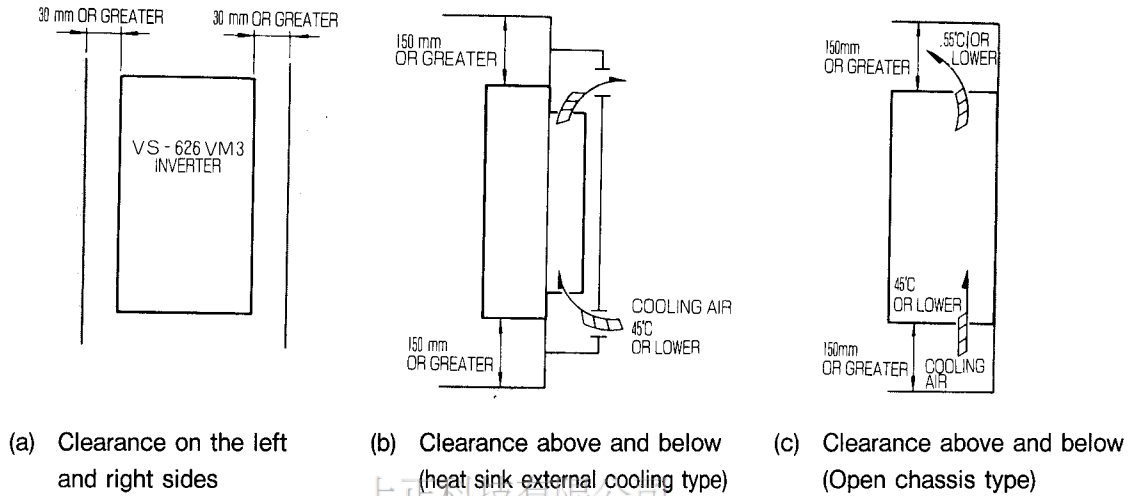

Fig. 11.3 Inverter Installation Space

11.2.2 Installation Orientation

For cooling efficiency and ease of maintenance, the inverter must be installed in a vertical position with the input- output terminals below.

- ★ - If the inverter is placed in a horizontal position, the inverter inside temperature exceeds the operating thermal range even when the output is within the rating, and the life of the electronic components may be significantly reduced.

Notes on assembling the control panel

Do not drill or weld the control panel after mounting the inverter. Otherwise, metal chips may be left in the inverter and lead to a failure.

11.3 CONNECTION

Fig. 11.4 shows equipment configuration for a drive system. Connect the power source, inverter, and motor properly according to the drive system layout and connection diagram. When the drive is to be used for single-motor drive and no system connection diagram is found, refer to Fig. 11.4.

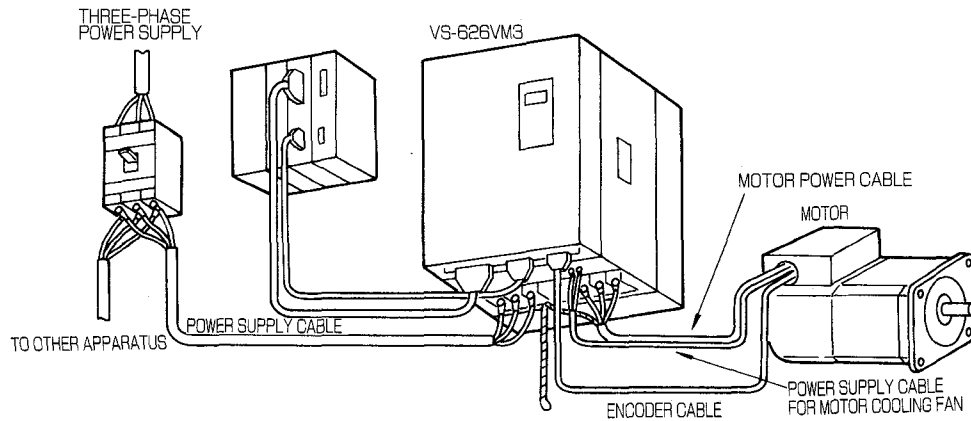

Fig. 11.4 Configuration for Single-Motor Drive System

上正科技有限公司
購買、維修 此手冊零組件

電話： 037-466333

Email: service@repairtw.com

Line id: @zzzz

www.repairtw.com

11.4 NOTES ON CONNECTION

Complete interconnections, following the instructions given below.

(1) Control signal leads (1CN to 3CN) must be separated from main circuit leads (R, S, T, U, V, W) and other power lines and power supply lines to prevent erroneous operation caused by noise interference (Electromagnetic interference).

- ★ - If a signal line (especially the motor encoder signal line) runs along a power cable, the dv/dt noise from the power cable may cause a serious malfunction.

(2) When a twisted shielded wire is used for the control signal line, the terminal must be insulated as shown in Fig. 11.5, except for the motor encoder signal line between the inverter and the motor which must be connected on both ends because the encoder signal line in the motor is a multicore shielded cable. The extension of the control signal line including the encoder signal line must be 20 m or less.

- ★ - A longer motor encoder signal line between the inverter and the motor may result in a voltage drop in the line, reducing encoder power voltage and causing a serious malfunction.

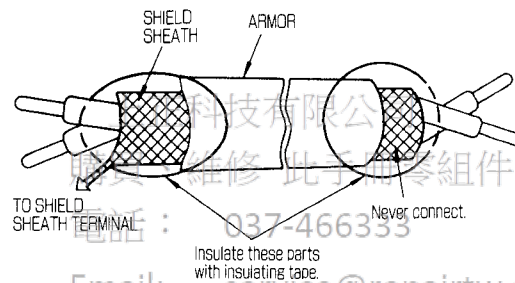

Fig. 11.5 Shielded Lead Termination

(3) Make a positive grounding using ground terminal E on the casing of VS-626VM3.

- Ground resistance should be 100Ω or less.
- Never ground VS-626VM3 in common with welding machines, motors, and other large-current electrical equipment, or ground pole. Run the ground lead in a separate conduit from leads for large-current electrical equipment.
- Use ground lead listed in technical standards of electric installation and make the length as short as possible.
- Even when VS-626VM3 or motor is grounded through its mountings such as channel base or steel plate, be sure to ground VS-626VM3 using the ground terminal E.
- Where several VS-626VM3 units are used side by side, all the units should preferably be grounded directly to the ground poles. However, connecting all the ground terminals of VS-626VM3 in parallel, and ground only one of VS-626VM3 to the ground pole is also permissible (Fig. 11.6 (a)). However, do not form a loop with the ground leads (Fig. 11.6 (b)).

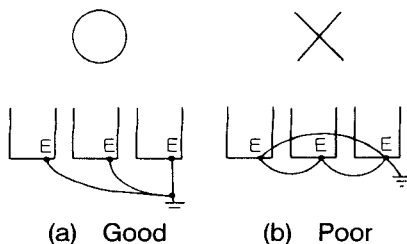

Fig. 11.6 Grounding of Three VS-626VM3 Units

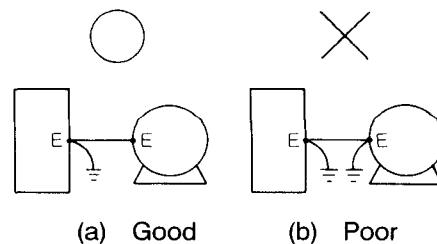

Fig. 11.7 Grounding of Motor and VS-626VM3

- (4) Phase rotation of input terminals (R, S, T) is available to each direction, clockwise and counter clockwise.
- (5) Never connect the power supply to output terminals (U, V, W).
- ★ - If the power supply is connected to an output terminal, excess current flows and internal transistors may be damaged.
- (6) Connect inverter output terminals (U, V, and W) to corresponding motor terminals (U, V, and W).
- ★ - Connection error may cause motor buzzing and vibration, or improper rotation.
- (7) It is possible that failures caused by grounding or short-circuiting of output cables may occur. Be careful not to let cables come in contact with the case.
- (8) Never connect phase advance capacitors between the inverter and the motor. (Fig. 11.8.)
- ★ - Inverter output overcurrent protect may be activated or the motor may run away. Phase advancing capacitors may be overheated or damaged by high-frequency component of inverter output voltage.

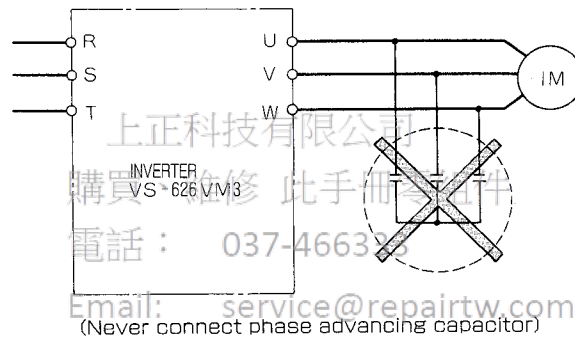

Fig. 11.8 Removal of Phase Advancing Capacitor
www.repairtw.com

(9) When a ground fault interrupter or leak relay is used, it must be well balanced and placed in the power supply line as shown in Fig. 11.9. Since output from the controller contains a high-frequency component, zero-phase current may flow through the voltage-to-ground capacitance of the inverter-motor cable (C1) or the voltage-to-ground capacitance of the motor (C2), improperly activating the ground fault interrupter. To avoid this, observe the following:

- (a) Make the cable between the inverter and the motor as short as possible to reduce steady zero-phase current.
- (b) Set rated sensitivity current high.
- (c) Use a specialized inverter or impulse wave inactive ground fault interrupter.

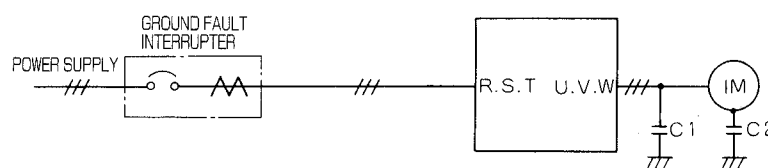

Fig. 11.9 Installation of Ground Fault Interrupter

(10) If both the VS-626VM3 inverter and magnetic contactor are placed in the same control panel, the controller may sometimes operate erroneously due to the noise generated from the coil of the magnetic contactor. Connect a surge suppressor in parallel with the coil of the magnetic contactor. The surge suppressor will absorb the energy stored in the coil of magnetic contactor and thus must have a capacity suited to the coil. YASKAWA's magnetic contactors and surge suppressor are shown in Table 11.1.

CAUTION

Never connect surge suppressor to the output terminals (U, V, W) of the controller.

- ★ - If there is no surge absorber, making or breaking of the magnetic contactor generates surge voltage from the winding, disrupting the signal on the inverter control signal line.

Table 11.1 Application of Surge Suppressor

Magnetic Contactor and Control Relay Type†		Surge Suppressor*		
		Type	Specifications	Code No.
200V Class	Magnetic-contactor HI-10E, -20E, -25E, -35E, -50E, -65E ₂ , -80E ₂ , -125E ₂	DCR2-50A22E	250VAC 0.5 μF + 200 Ω	C002417
	Control relay RA-6E ₂ , RL-33E			
	Control relay LY-2, -3 [Manufacturer: OMRON Corporation] HH-22, -33 [Manufacturer: FUJIElectric Corporation] MM-2, -4 [Manufacturer: OMRON Corporation]	DCR2-10A25C	250VAC 0.5 μF + 200 Ω	C002482

* Surge suppressor is made by MARCON ELECTRONICS Co., Ltd.
Use the surge suppressor shown below when any surge suppressor is used other than the above.

200V class: Type DCR2-50A22E

† Magnetic contactor and control relay are made by YASKAWA CONTROLS Co., Ltd.

12. PREPARATION BEFORE STARTING

12.1 CHECK BEFORE TURNING ON POWER

After installation and wiring, check the following before turning ON power:

(1) Verify that capacity and type of the motor and the inverter match specifications of the load machine.

- Refer to the nameplates of the motor and the inverter.

(2) Check wiring between equipment with the connection diagram.

Do not activate the buzzer for checking when the control circuit is connected.

(3) Check for loose terminals and connectors.

- Main circuit screw terminals of the motor and the inverter
- Screw terminals of the fan power source and the magnetic contactor of the motor and the inverter
- Fastening bolts at the motor and the inverter

(4) Verify that the motor and the inverter are grounded securely.

(5) Verify that signal line connectors are securely inserted in the specified places.

- Signal line connectors of the inverter, motor encoder, and magnetic sensor

(6) Check that wire pieces and metal chips are not in the conducting parts.

(7) Verify that the motor and the load machine are ready to operate.

- Check for obstacles around the rotor.
- Verify that emergency stop and collision prevention function normally.

12.2 CHECKING POWER VOLTAGE

Turn OFF the molded-case circuit-breaker (MCCB) on the supply side of the inverter to verify the power input voltage supplied to the primary side of the MCCB. Use a voltmeter or rotation meter (volt-ammeter) to measure the input voltage. Table 12.1 shows allowable ranges of input voltage:

Table 12.1 Allowable Ranges of Power Voltage

Inverter	Nominal Voltage/ Frequency	Allowable Voltage Variation Range*
200V Series	200V/ 50, 60 Hz	170 ~ 242 V
	220V/ 50, 60 Hz	
	230V/ 60 Hz	170 ~ 253 V
400V Series	380V/	340 ~ 484 V
	400V/ 50, 60 Hz	
	440V/ 50, 60 Hz	
	460V/ 60 Hz	340 ~ 506 V

* VS-626VM3 is operational within the voltage variation range specified in the above table; however, the 200V series shows optimum characteristics at 200 to 240V and the 400V series at 400 to 480V. Thus, if supply voltage is lower than the basic 200V or 400V, specified output may not be obtained during high-speed operation. If input voltage can be varied by a changer, set the input voltage within the above ranges for optimum operation.

12.3 SELECTION CONNECTOR SETUP FOR DIFFERENT SPEED REFERENCE INPUT METHODS

Set up the selection connectors according to Table 12.2 depending on whether analog or digital references are used and other classifications of the speed reference input method.

Table 12.2 Setting of Speed Instruction Selection Connectors

Speed Reference Input Method	Power Supply Select Connector for Speed Reference (A1/ A2)	Terminal Select Connector for Speed Reference Input* (AX2/ D12)	Speed Reference Select Signal (DAS)																																																																										
<p>When a variable resistor of 2 kΩ is used</p>			ANALOG SPEED REFERENCE																																																																										
<p>When resistors of other types are used</p>																																																																													
<p>When external voltage source (such as digital-analog converter) is used (1CN input)</p>				OPEN																																																																									
<p>When external voltage source (such as digital-analog converter) is used (2CN input)</p>																																																																													
<table border="1"> <thead> <tr> <th colspan="2">BCD</th> <th rowspan="2">BIN</th> <th colspan="2">2CN</th> </tr> <tr> <th>3-digit</th> <th>2-digit</th> <th></th> <th></th> </tr> </thead> <tbody> <tr><td>1</td><td>—</td><td>1</td><td>1</td><td>D1</td></tr> <tr><td>2</td><td>—</td><td>2</td><td>2</td><td>D2</td></tr> <tr><td>4</td><td>—</td><td>4</td><td>3</td><td>D3</td></tr> <tr><td>8</td><td>—</td><td>8</td><td>4</td><td>D4</td></tr> <tr><td>10</td><td>1</td><td>16</td><td>5</td><td>D5</td></tr> <tr><td>20</td><td>2</td><td>32</td><td>6</td><td>D6</td></tr> <tr><td>40</td><td>4</td><td>64</td><td>7</td><td>D7</td></tr> <tr><td>80</td><td>8</td><td>128</td><td>8</td><td>D8</td></tr> <tr><td>100</td><td>10</td><td>256</td><td>9</td><td>D9</td></tr> <tr><td>200</td><td>20</td><td>512</td><td>10</td><td>D10</td></tr> <tr><td>400</td><td>40</td><td>1024</td><td>11</td><td>D11</td></tr> <tr><td>800</td><td>80</td><td>2048</td><td>12</td><td>D12</td></tr> <tr><td></td><td></td><td></td><td>13</td><td>0V</td></tr> </tbody> </table>	BCD		BIN	2CN		3-digit	2-digit			1	—	1	1	D1	2	—	2	2	D2	4	—	4	3	D3	8	—	8	4	D4	10	1	16	5	D5	20	2	32	6	D6	40	4	64	7	D7	80	8	128	8	D8	100	10	256	9	D9	200	20	512	10	D10	400	40	1024	11	D11	800	80	2048	12	D12				13	0V	<p>Either can be selected.</p> <p>(Standard setting is)</p>		CLOSE
BCD		BIN		2CN																																																																									
3-digit	2-digit																																																																												
1	—	1	1	D1																																																																									
2	—	2	2	D2																																																																									
4	—	4	3	D3																																																																									
8	—	8	4	D4																																																																									
10	1	16	5	D5																																																																									
20	2	32	6	D6																																																																									
40	4	64	7	D7																																																																									
80	8	128	8	D8																																																																									
100	10	256	9	D9																																																																									
200	20	512	10	D10																																																																									
400	40	1024	11	D11																																																																									
800	80	2048	12	D12																																																																									
			13	0V																																																																									

* There are two speed reference terminal connectors. Set up the two terminals in the same way.

13. OPERATION OF DIGITAL OPERATOR

Notes on use of the digital operator

This section explains the functions, operation method, and control constants of the digital operator. Become thoroughly familiar with the different procedures before turning power ON.

13.1 FUNCTIONS OF THE DIGITAL OPERATOR

VS-626VM3 supports the multi-functional display operator that enables the following:

(1) **Display of Control Signal Status**

Status of control signals of individual points is displayed by monitoring the status of operation. For the display items, see Table 13.3.

(2) **Display and Setup of Control Constants**

Control constants must be set up for normal operation in compliance with the specifications. Tables 13.4 to 13.6 list the control constants.

(3) **Display of Protective functions**

If an error occurs during operation, protective functions are displayed. Table 13.7 lists the protective functions. Nothing is displayed when operation is normal.

(4) **Function by the Digital Operator**

Stand-alone operation without sequence input signals or speed reference is possible by setting control constant C1-37 with the digital operator. This function is effective for test run when the inverter is connected only with a motor. For the details of the operation, see Paragraph. 8.1.

Fig 13.1 shows the display unit and operation keys of the digital operator (JVOP-100).

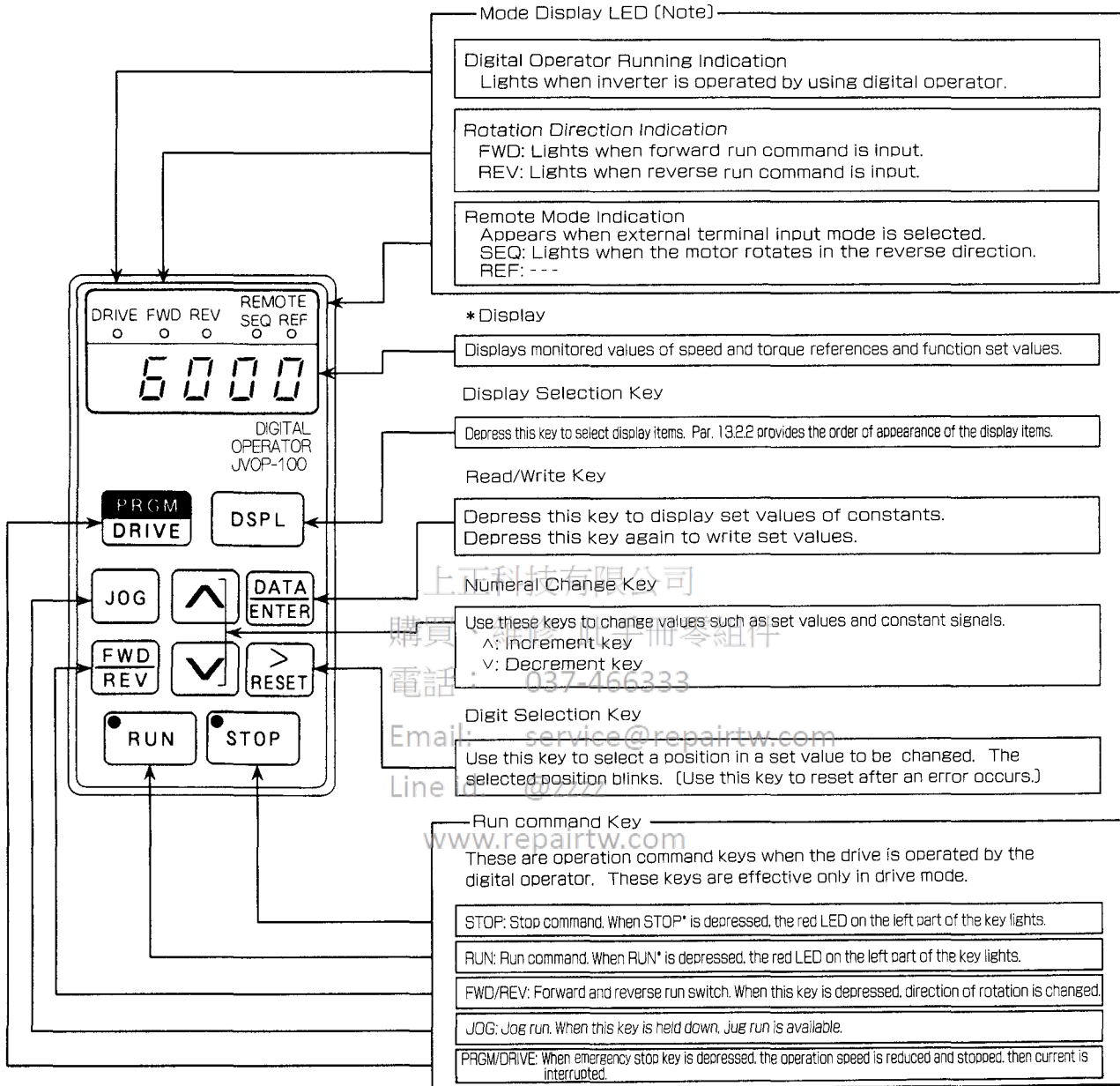

* Digital display LEDs and status display LEDs are used.

Fig. 13.1 Display Unit and Operation Keys of the Digital Operator (JVOP-100)

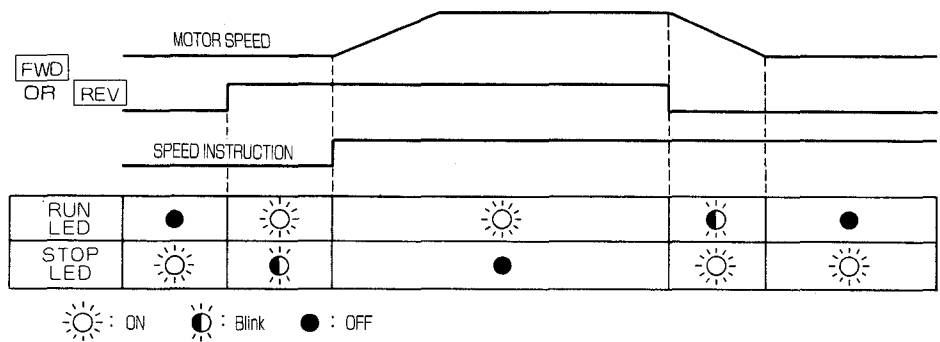

Note: RUN and STOP LEDs light, blink, and go OFF depending on the status of operation.

Fig. 13.2 Digital Operator Display

13.2 KEY OPERATIONS AND DISPLAY

Operations of the keys and indications of the digital operator are explained below. Table 13.1 corresponds displayed characters to alphanumeric characters.

Table 13.1 Indication of Numbers and Letters by 7-segment LED

No.	Letters				
0	0	A	A	N	-
1	1	B	o	O	-
2	2	C	L	P	P
3	3	D	d	Q	-
4	4	E	E	R	-
5	5	F	F	S	-
6	6	G	-	T	-
7	7	H	-	U	-
8	8	I	-	V	U
9	9	J	-	W	-
.	.	K	-	X	-
-	-	L	-	Y	-
		M	-	Z	-

Note: "-" is not displayed.

13.2.1 Indication at Power-ON

When power is turned ON, all the LEDs of the digital operator light for LEDs selfcheck.



Then the PROM version is displayed. The upper five digits of the PROM number are displayed. The example is for PROM number "NSN620100."



Finally, operation status data V1-01 (motor speed) is displayed. Since the motor is not rotating immediately after the power is turned ON, 0 is displayed.

If a protective function is activated because of a failure, the failure indication number lights. The example indicates a break in a wire in the motor thermistor, which appears when the motor encoder signal connector (3CN) is disconnected.

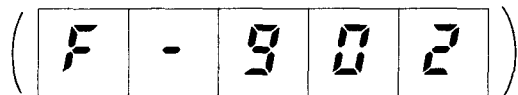
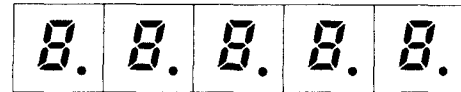

13.2.2 Switching Display Functions

Depress the **DSPL** key on the digital operator to change the mode of display.



Depressing the **DSPL** key once changes the display from motor speed data to a data number. The first letter V indicates that operation status display mode has been selected.



Depress the **DSPL** key again. Operation status display mode is changed to control constant display mode. In this mode, control constants can be set and changed.



Depress the **DSPL** key again. Usually, if no protective function is activated, operation status display mode is restored. If bits 0 or 1 of control constant C1-37 are set ON, reference display mode of operation by the digital operator is entered.

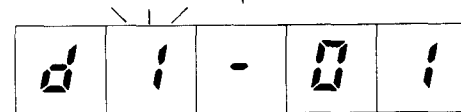
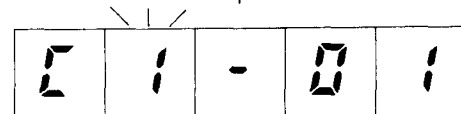
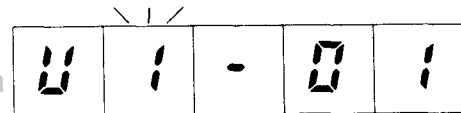

上正科技有限公司
 購買、維修 此手冊零組件
 電話： 037-466333
 Email: service@repairtw.com

Line id: @zzzz
 www.repairtw.com

When the **DSPL** key is depressed in digital operator operation mode, operation status display mode is restored provided that no protective function has been activated. If a protective function is activated because of a failure, the failure indication number lights. The example indicates a break in a wire in the motor thermistor.

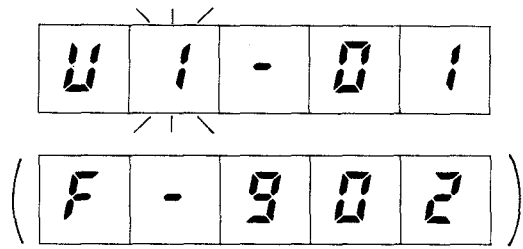

13.2.3 Operation Status Display Mode

To check data in operation status display mode, do as follows.

To change a data number, depress **>** key once. The blinking cursor moves to the displayed data number. Depress **>** key again to return the blinking cursor to its initial position.

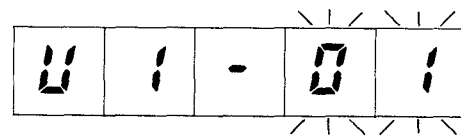

Search for the data number to be checked (in this example, V1-09) using **▲** or **▼** key.

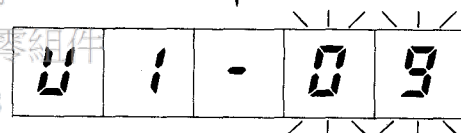

Depress the **DATA** key to change data number display to data contents display. The display example is the status when **RDY** and **EMG** signals are closed.



To return to data number display from data contents display, depress the **DSPL** key.

For explanations of operation status display, see Table 13.3.

13.2.4 Control Constant Display Mode

To check data or set or change a constant in control constant display mode, do as follows.

To change a data number, depress $\boxed{>}$ key once. The blinking cursor moves to the displayed data number. Depress $\boxed{>}$ key again to return the blinking cursor to its initial position.



Search for the data number to be checked (in this example, C1-10) using $\boxed{\wedge}$ or $\boxed{\vee}$ key.



Depress the $\boxed{\text{DATA}}$ key to change data number display to data contents display.



Select the position in the data to be changed and depress $\boxed{>}$ key to move the blinking cursor.



Use $\boxed{\wedge}$ or $\boxed{\vee}$ key to change the data. (In this case, from "1" to "5")



Hold down the $\boxed{\text{DATA}}$ key for several seconds. The entire data blinks for several seconds, then stops blinking. The data has been changed. (The entire data continuously blinks if the data is out of the setting range. If this occurs, depress the $\boxed{\text{DSPL}}$ key to change from data contents display to data number display, then restart setting from the beginning.)



To return to data contents display from data number display, depress the $\boxed{\text{DSPL}}$ key.

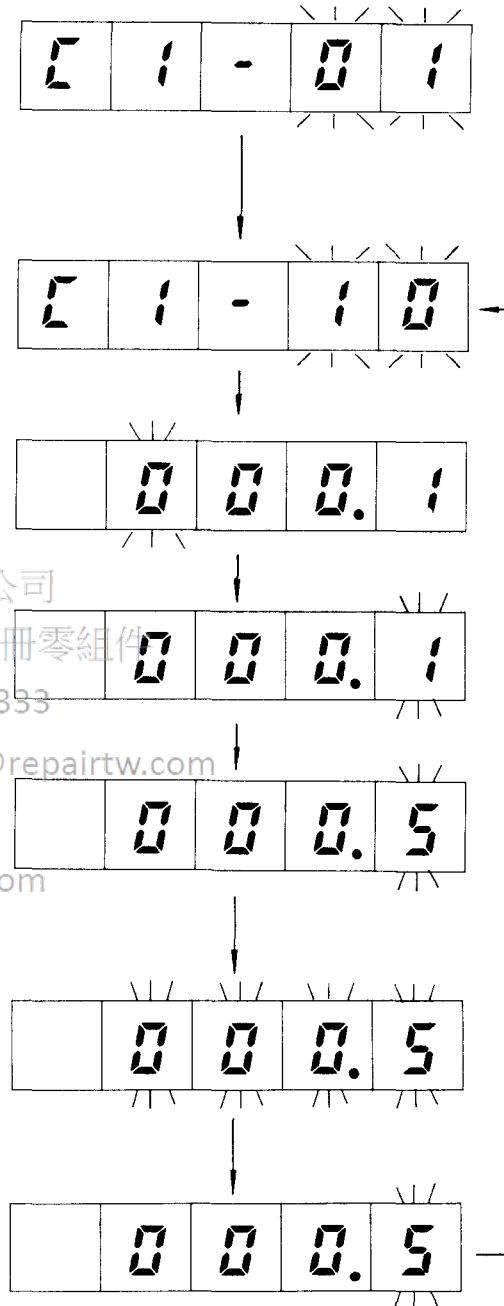

For explanations of control constants, see Tables 13.4 to 13.6.

Note: C1-01 to 24, C2-01 to 08, C3-01 to 08 can be changed during operation or stop. C1-25 to 48, C2-09 to 24, C3-09 to 24 can be changed only during stop.

13.2.5 Protective Function Operation Display Mode

If a protective function is activated because of a failure, the protective function indication number is displayed. After an error is reset, up to four protective operations are recorded to view the order of a series of failures.

First protective function operation is indicated with an F followed by a hyphen.

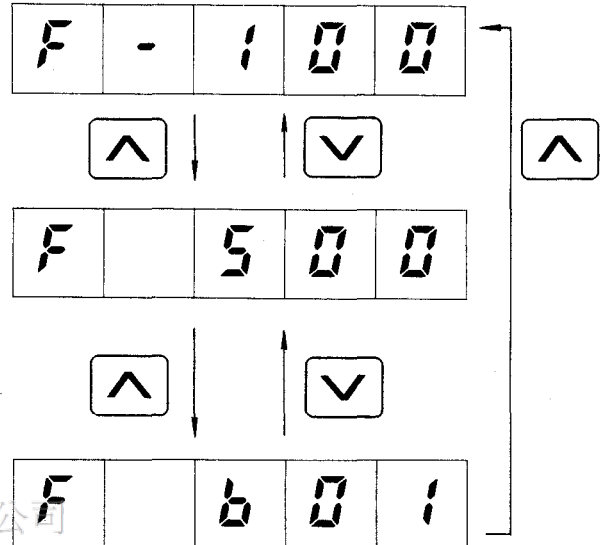

Depress $\boxed{\wedge}$ key to display the protect display number which activated the next protective function.

If $\boxed{\wedge}$ key is depressed when the last failure display number is displayed, the first failure display number is displayed again. Depress $\boxed{\vee}$ key to display failure display numbers in reverse order of occurrence.

電話：037-466333
 上正科技有限公司
 購買、維修 此手冊零組件
 www.repairtw.com

Notes on resetting failures
 To reset a failure by the digital operator after removing the cause, depress the **RESET** key in protective function operation display mode. In other modes, the **RESET** key cannot reset the failure. Before resetting, turn OFF **FWD**, **REV**, and **ORT** signals.

13.2.6 Digital Operator Operation Mode

To operate by the digital operator, do as follows.

Select C1-37 in control constant display mode.

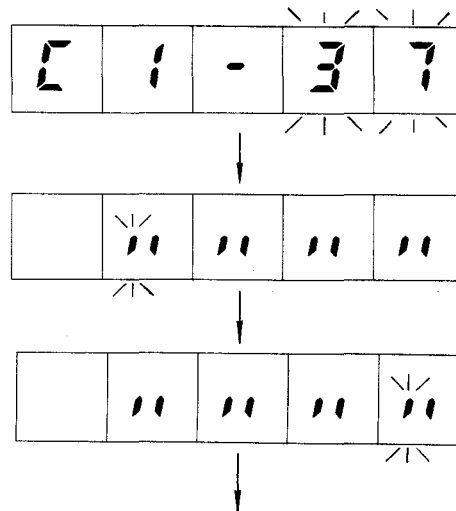

Depress the **DATA** key to change from data number display to data contents display.

Select the position in the data to be changed and depress $\boxed{>}$ key to move the blinking cursor. Set the lower two bits ON.

Use $\square \wedge$ or $\square \vee$ key to change the data. (In this case, the lower two bits are changed from " " to " ")

Operation step ($\square \wedge$, $\square \vee$, $\square \wedge$, $\square \vee$)

Hold down the **DATA** key for several seconds. The entire data blinks for several seconds, then stops blinking. The data has been changed.

Depress the **DSPL** key to return to data number display from data contents display. Digital operator operation mode is entered.

Then set up for speed reference.

Depress the **DSPL** key to select "reference constant" for digital operator operation. Use cursor keys $\square \vee$, $\square \wedge$, or $\square \vee$ to set a speed reference for d1-02. Speed reference is expressed as a percent of the rated speed setting (C1-26). If 25% is set when rated speed is 6000 r/min, the reference translates into 1500 r/min.

電話： 037-466333

Email: service@repairtw.com

For operation, stop, and forward/reverse run, use the **RUN** , **STOP** , and **FWD/REV** keys respectively on the digital operator. Display on the digital operator changes each time the **DSPL** key is depressed from constants (C1-01, and so on) to variables (V1-01, . . .) to reference (d1-01, . . .). Operation control signals and speed reference displayed among reference display are handled similar to constant setup. Table 13.2 lists the parameters.

To return from digital operator operation mode to normal operation by external run command, change the lower two bits of C1-37 from " " to " "

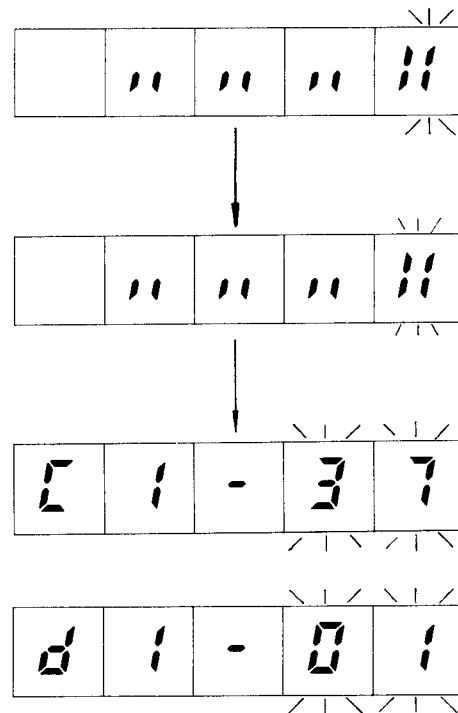

Table 13.2 Parameters for Digital Operator Operations

Constant No.	Explanation	Unit	Initial Value in Digital Operator Operation
d1-01	Sequence input	Binary	
d1-02	Speed reference	%	% display for rated speed setting (C1-26). Initial value: 0.00

13.3 OPERATION STATUS DISPLAY FUNCTION

Different groups of operation status indications are displayed for different modes of operation. V1 indications are for inverter operation. V2 indications are for optional encoder orientation control. V3 indications are for magnetic sensor orientation control, which is also optional. (Data marked with * are operation status display data for preset.)

Table 13.3 (a) Operation Status Display Functions (For Inverter Operation)

No.	Signal Name	Explanation	Unit
V1-01	Motor Speed	Speed detected by the motor encoder	r/min
V1-02	Speed Reference	Speed control reference. Ratio of analog or digital reference to the rated speed	%
V1-03	Load Shaft Speed	Product of motor speed and gear transmission ratio	r/min
V1-04	Torque Reference	Percentage to 30-minute rating (100%)	%
V1-05	—		
V1-06	Inverter Output Current	Detected inverter output current converted to amperes. Precision is $\pm 3\%$.	A
V1-07	Output Frequency	Inverter current output frequency	Hz
*V1-08	Internal Status	Operation status signal (at logical level)	
V1-09	Input Signal Status	Sequence input signal ON/OFF state ^(Note)	
V1-10	Output Signal Status	Sequence output signal ON/OFF state ^(Note)	
V1-11	Inverter Capacity	Inverter unit 30-minute rated capacity	kW
V1-12	Panel Internal Temperature	Detected inverter ambient temperature. Precision is $\pm 5^\circ\text{C}$.	$^\circ\text{C}$
V1-13	Heat Sink Temperature	Detected heat sink temperature of inverter. Precision is $\pm 5^\circ\text{C}$.	$^\circ\text{C}$
*V1-14	DC Bus Voltage	Main circuit capacitor voltage. Precision is $\pm 3\%$.	V
V1-15	Analog Speed Reference AD Converted Value	Converted value of analog reference to be used for speed reference offset adjustment. Available only during running.	
*V1-16	—		
*V1-17	Phase-U current	Detected phase-U current converted from analog to digital	
*V1-18	Phase-W current	Detected phase-W current converted from analog to digital	

Table 13.3 (b) List of Operation Status Display Functions (For Encoder Orientation Control)

No.	Signal Name	Explanation	Unit
V2-01	I/O Signal Status	Orientation I/O signal status ^(Note)	
V2-02	-----		
V2-03	Position Monitor	Actual position expressed by dividing one rotation by 4096 in reference to a set origin	Pulses
V2-04	Commanded Stop Position	Commanded stop position expressed by dividing one rotation by 4096 in reference to a set origin	Pulses
V2-05	Position Deviation	Difference between commanded stop position and current position in pulses	Pulses
V2-06	Positioning Time	Time from input of orientation command to output of completion signal	$\times 2$ ms

Table 13.3 (c) List of Operation Status Display Functions
(For Magnetic Sensor Orientation Control)

No.	Signal Name	Explanation	Unit
V3-01	I/O Signal Status	Orientation I/O signal status ^(Note)	
V3-02	Magnetic Sensor Signal Level	—	
V3-03	Position Monitor	Actual position expressed in reference to a set origin	Pulses
V3-04	Commanded Stop Position	Commanded stop position expressed in reference to a set origin	Pulses
V3-05	Position Deviation	Difference between commanded stop position and current position in pulses	Pulses
V3-06	Positioning Time	Time from input of orientation command to output of completion signal	×2 ms

Table 13.3 (d) List of Operation Status Display Functions (Others)

No.	Signal Name	Explanation	Unit
V7-01	Motor Temperature	Detected temperature for motor overheat protection	°C
*V7-02	Slip Frequency	Slip frequency to be applied to the motor	Hz

Note : Status of I/O signals are shown in the following
Lamps of input signals in the ON-state light.

電話： 037-466333

Email: service@repairtw.com

Line id: @zzzz

www.repairtw.com

<V1-09> Sequence Input Signal Status Display

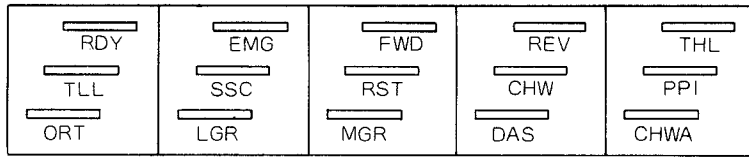

<V1-10> Sequence Output Signal Status Display

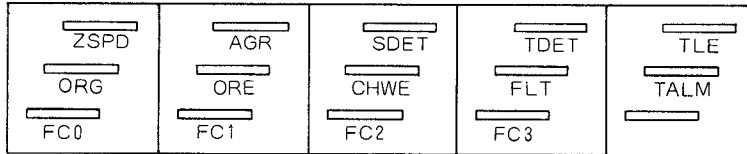

<V2-01> I/O Signal Status for Encoder Orientation Control Display

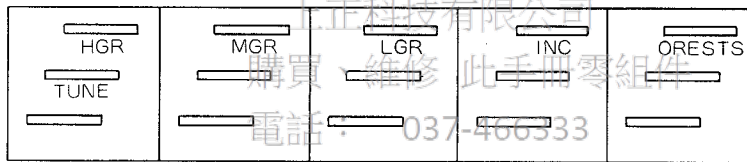

Email: service@repairtw.com

Line id: @zzzz

<V3-01> I/O Signal Status for Magnetic Sensor Orientation Control Display

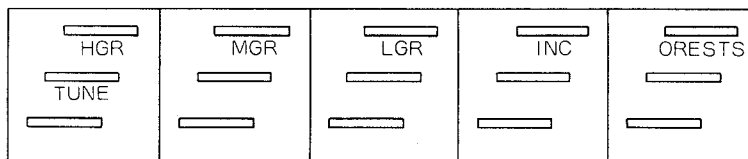

13.4 CONTROL CONSTANTS

Different groups of control constants are displayed for different modes of operation. User constants (C1) are for inverter operation. C2 constants are for optional encoder orientation control. C3 constants are for magnetic sensor orientation control, which is also optional. The following constants cannot be changed during running:

C1-25 to C1-40, C2-09 to C2-24, C3-09 to C3-24

Change the constants after stopping the motor.

Table 13.4 User Constant List

Constant No.	Constant Name	Explanation	Unit	Upper Limit
				Lower Limit
C1-01	Speed Control Proportional Gain(H) K_{VHN}	Speed control proportional gain when high-speed gear is selected (MGR and LGR are OFF) or when high-speed winding is selected (CHW is OFF). Raising K_{VHN} increases rigidity. Torque Reference $P = K_{VHN} \times \text{Speed Tolerance}$	% / Hz	255
				1
C1-02	Speed Control Integral Time Constant (H) τ_{VHN}	Speed control integral time constant when high-speed gear is selected (MGR and LGR are OFF) or when high-speed winding is selected (CHW is OFF). Reducing τ_{VHN} quickens response. Torque Reference $I = \text{Speed tolerance} \times \text{Time} / \tau_{VHN}$	ms	1000
				5
C1-03	Speed Control Proportional Gain (M,L) K_{VLN}	Speed control proportional gain when low-speed gear is selected (MGR or LGR is ON) or when low-speed winding is selected (CHW is ON). Raising K_{VLN} increases rigidity. Torque Reference $P = K_{VLN} \times \text{Speed Tolerance}$	% / Hz	255
				1
C1-04	Speed Control Integral Time Constant (M,L) τ_{VLN}	Speed control integral time constant when low-speed gear is selected (MGR or LGR is ON) or when low-speed winding is selected (CHW is ON). Reducing τ_{VLN} quickens response. Torque Reference $I = \text{Speed Tolerance} \times \text{Time} / \tau_{VLN}$	ms	1000
				5
C1-05	Speed Control Proportional Gain(H) K_{VHS}	Speed control proportional gain when high-speed gear is selected (MGR and LGR are OFF) or when high-speed winding is selected (CHW is OFF) in servo mode (SV is ON). Torque Reference $P = K_{VHS} \times \text{Speed Tolerance}$	% / Hz	255
				1
C1-06	Speed Control Integral Time Constant (H) τ_{VHS}	Speed control integral time constant when high-speed gear is selected (MGR and LGR are OFF) or when high-speed winding is selected (CHW is OFF) in servo mode (SV is ON). Torque Reference $I = \text{Speed Tolerance} \times \text{Time} / \tau_{VHS}$	ms	1000
				5
C1-07	Speed Control Proportional Gain (M,L) K_{VLS}	Speed control proportional gain when low-speed gear is selected (MGR or LGR is ON) or when low-speed winding is selected (CHW is ON) in servo mode (SV is ON). Torque Reference $P = K_{VLS} \times \text{Speed Tolerance}$	% / Hz	255
				1
C1-08	Speed Control Integral Time Constant (M,L) τ_{VLS}	Speed control integral time constant when low-speed gear is selected (MGR or LGR is ON) or when low-speed winding is selected (CHW is ON) in servo mode (SV is ON). Torque Reference $I_N = \text{Speed Tolerance} \times \text{Time} / \tau_{VLS}$	ms	1000
				5
C1-09	Torque Reference Filter Time Constant τ_T	Time constant of low-pass filter of torque reference to be used in measures against gear chattering noise. Increasing the time constant may cause run-away depending on conditions.	ms	5.0
				0.0
C1-10	Soft Start Time T_{SFS}	Setting of required time for soft starter. Variations in speed reference are suppressed according to the speed change ratio of the set time. Starting time from at rest state is obtained as follows: Starting Time = $T_{SFS} \times \text{Speed Instruction} (\%) / 100$	s	180.0
				0.1
C1-11	Speed Reference offset adjustment value SC_{OFS}	Offset adjustment value for analog speed reference. Set the values of V1-15 when operating at speed reference 0 for C1-11.		80
				-80
C1-12	Motor Speed Adjustment Value S_{ADJ}	Constant for fine control of motor speed when analog speed reference are used. Speed is increased in proportion to S_{ADJ} . This parameter is invalid when digital speed reference are used.		1.1000
				0.9000

Table 13.4 User Constant List (Cont'd)

Constant No.	Constant Name	Explanation	Unit	Upper Limit
				Lower Limit
*C1-13	Torque Reference Offset TC _{OFFS}	-----		80
				-80
*C1-14	Torque Reference Adjustment Value T _{ADJ}	-----		1.100
				0.900
*C1-15	Speed Limiter S _{LIM}	-----	%	100
				0
C1-16	Speedometer Signal Adjustment Value SM _{ADJ}	Constant for fine control to match the commanded torque and indication on the load ratio meter. Increasing LM _{ADJ} makes the meter indicator travel farther.		1.50
				0.90
C1-17	Load Ratio Meter Signal Adjustment Value LM _{ADJ}	Constant for fine control to match the commanded torque and indication on the load ratio meter. Increasing LM _{ADJ} makes the meter indicator travel farther.		1.50
				0.90
C1-18	Load Ratio Meter Full-scale LN _{FS}	Setting of full-scale value of the load ratio meter expressed as a percent of continuous rating. Note that the full-scale value depends on specifications of the load machine.	%	350
				120
C1-19	Zero-speed Detection Level ZS _{LVL}	Detection level of zero-speed signal (ZSPD) Standard setting is 30r/min.	r/min	60
				3
C1-20	Speed Agree Signal Detection Width AGR _{BD}	Detection width of speed-match signal at rated speed Standard setting is 15%.	%	50
				10
C1-21	Speed Detection Signal Level SD _{LVL}	Speed detection signal (SDET) activation level used for winding selection. Expressed as a percent of the motor rated speed.	%	100
				0
C1-22	Speed Detection Signal Detection Width SD _{HYS}	Hysteresis width adjustment level of speed signal detection. During acceleration, SD _{LVL} +SD _{HYS} is detected. During deceleration, SD _{LVL} -SD _{HYS} is detected. Expressed as a percent of the motor rated speed.	%	10.00
				0.00
C1-23	Torque Detection Signal Operation Level TD _{LVL}	Torque detection signal (TDET) activation level used to detect abnormal loads. Expressed as a percent of the 30-minute rated torque. Hysteresis width is limited to ±10%.	%	120
				5
C1-24	External Control Torque Limiting Level TL _{EXT}	Torque limit using external torque limiting signals (TLL and TLH). Expressed as a percent of the 30-minute rated torque.	%	120
				5
C1-25	Motor Code Selection MTR	Select applicable motor from the motor codes stored in inverter memory. Expressed in 2-digit hexadecimals 0 to F. Available after selecting the code and then turning power ON again.		FF
				01
C1-26	Rated Speed Setting S ₁₀₀	Rated speed set according to load machine specifications. Must not be greater than the motor maximum speed. When speed reference is 100%, this speed is applied.	r/min	Max. Speed
				100
C1-27	Transmission Ratio 1 R _{HGR}	Transmission ratio determined by mechanical specifications. This parameter is valid when H gear is selected (MGR, LGR : OFF). Transmission Ratio = Spindle speed ÷ Motor Speed		2.5000
				0.0400
C1-28	Transmission Ratio 2 R _{MGR}	Transmission ratio determined by mechanical specifications. This parameter is valid when M gear is selected (MGR : ON). Transmission Ratio = Spindle speed ÷ Motor Speed		2.5000
				0.0400

Table 13.4 User Constant List (Cont'd)

Constant No.	Constant Name	Explanation	Unit	Upper Limit	Lower Limit
C1-29	Transmission Ratio 3 (L) R_{LGR}	Transmission ratio determined by mechanical specifications. This parameter is valid when L gear is selected (LGR : ON). Transmission Ratio = Load Shaft Speed ÷ Motor Speed		2.5000	
					0.0400
C1-30	Motor Flux Lower Limit Level ϕ_{WL}	Level limit motor flux reduction control lower.	%	100	
					15
C1-31	Servo Mode Flux Level (H) ϕ_{SVH}	Motor flux level when high-speed gear is selected (MGR) and LGR are OFF) or when high-speed winding is selected (CHW is OFF) in servo mode (SV is ON).	%	100	
					30
C1-32	Servo Mode Basic Speed Ratio (H) R_{BSH}	Base speed ratio when high-speed gear is selected (MGR and LGR are OFF) or when high-speed winding is selected (CHW is OFF) in servo mode (SV is ON). Base Speed (Servo) = $R_{BSL} \times$ Base Speed (Motor)		5.00	
					1.00
C1-33	Servo Mode Flux Level (M,L) ϕ_{SVL}	Motor flux level when low-speed gear is selected (MGR or LGR is ON) or when low-speed winding is selected (CHW is ON) in servo mode (SV is ON).	%	100	
					30
C1-34	Servo Mode Basic Speed Ratio (M, L) R_{BSL}	Base speed ratio when low-speed gear is selected (MGR or LGR is ON) or when low-speed winding is selected (CHW is ON) in servo mode (SV is ON). Base Speed (Servo) = $R_{BSL} \times$ Base Speed (Motor)		5.00	
					1.00
C1-35	Zero-speed Brake Time T_{BLK}	Time for generating braking force after deceleration and zero-speed is reached to stop.	s	100	
					0
C1-36	Select Signal 1 SEL 1*	<p>Email: service@repairtw.com</p> <p>Setting signal for multi-functional selection. For further explanation, see Par. 4.8.1, "Sequence Input Signals."</p> <ul style="list-style-type: none"> • Bits 1 and 0 : 1CN, pin 11 <ul style="list-style-type: none"> 00 : TLL 01 : -- 10 : INC 11 : -- • Bit 2: 1CN pin 10 <ul style="list-style-type: none"> 0 : TLH 1 : -- • Bit 3: 1CN pin 10 <ul style="list-style-type: none"> 0 : SSC 1 : SV • Bit 4: 1CN pin 15 <ul style="list-style-type: none"> 0 : PPI 1 : LM10 • Bit 7: 2CN 12-bit digital reference <ul style="list-style-type: none"> 0 : Digital speed reference 1 : Orientation control stop position reference 		---	

C1-37	Select Signal 2 SEL 2*	<p>Setting signal for multi-functional selection. For further explanation, see Par. 4.8.2, "Speed Reference."</p> <p>Bits 1 and 0: Operation mode</p> <ul style="list-style-type: none"> 00: Operation by speed reference 11: Operation by the digital operator <p>Bits 3 and 2: Preparation for operation signal selection</p> <ul style="list-style-type: none"> 00: Free run by current interruption 01: After deceleration stop, interrupts current and MC is OFF. 10: After deceleration stop, interrupts current and MC is ON. <p>Bits 7 and 6: Digital speed reference selection</p> <ul style="list-style-type: none"> 00: 2-digit BCD 01: 12-bit binary 10: 3-digit BCD 11: Internal speed setting 		---	

* In explanation of select signals, 0 stands for "0" and 1 for "1".

Table 13.4 User Constant List (cont'd)

Constant No.	Constant Name	Explanation	Unit	Upper Limit								
				Lower Limit								
C1-38	Select Signal 3 SEL 3*	<p>Select signal for control mode and level</p> <ul style="list-style-type: none"> • Bits 1 and 0: Load factor meter filter <ul style="list-style-type: none"> 00: 2ms filter 01: 10ms filter 10: 100ms filter 11: 500ms filter • Bit 2: Torque limiting auto judgement <ul style="list-style-type: none"> 0: Not judged 1: Judged • Bit 3: Servo mode sensitivity <ul style="list-style-type: none"> 0: reference (10V/100%) 1: reference (10V/5000r/min) • Bit 4: Speed over-deviation protective (F800) operation threshold <ul style="list-style-type: none"> 0: 1/2 or less of speed reference 1: 1/4 or less of speed reference • Bit 5: Speed limiting level <ul style="list-style-type: none"> 0: 105% of rating reference 1: 110% of rating reference • Bit 6: Speed agreed signal output select at zero-speed <ul style="list-style-type: none"> 0: Outputs (AGR is close) 1: Does not output (AGR is open) • Bit 7: Load factor meter adjustment method <ul style="list-style-type: none"> 0: Outputs 120% signal of 30-minute rating 1: Outputs 100% signal of continuous rating 		---								
C1-39	Select Signal 4 SEL 4*	<p>Control mode select signal</p> <ul style="list-style-type: none"> • Bits 0: Orientation method <ul style="list-style-type: none"> 0: Encoder 1: Magnetic sensor 		---								
C1-40	Select Signal 5 SEL 5*	<p>Control mode select signal</p> <ul style="list-style-type: none"> • Bits 1 and 0: Excess speed deviation protective (F800) operation delay time select <ul style="list-style-type: none"> 00: 0 sec 01: 0.3sec 10: 0.4sec 11: 0.5sec • Bit 3: NC orientation selection <ul style="list-style-type: none"> 0: Invalid 1: Valid. Even if orientation signal (ORT) is input, orientation operation does not start. The rotation direction of the motor is decided depending on the polarity of analog speed reference. • Bit 4: Output selection of load factor meter <ul style="list-style-type: none"> 0: Continuous rating output 1: 30-minute rating output • Bit 5: Speed reference read gain selection in servo mode <ul style="list-style-type: none"> 0: Analog speed reference of 10V is regarded as rated speed setting (C1-26) 1: When bit 3 of C1-38 is "1", analog speed reference read gain can be changed 		---								
C1-41 to C1-48	Internal Speed Reference Set Values SPD 1 SPD 8	<p>Internal speed setting for digital speed reference. The values correspond to input command (from 2CN) as follows. Expressed as a percent of the rated speed.</p> <table style="width: 100%; border: none;"> <tr> <td>Pin 1 : SPD 1</td> <td>Pin 5 : SPD 5</td> </tr> <tr> <td>Pin 2 : SPD 2</td> <td>Pin 6 : SPD 6</td> </tr> <tr> <td>Pin 3 : SPD 3</td> <td>Pin 7 : SPD 7</td> </tr> <tr> <td>Pin 4 : SPD 4</td> <td>Pin 8 : SPD 8</td> </tr> </table>	Pin 1 : SPD 1	Pin 5 : SPD 5	Pin 2 : SPD 2	Pin 6 : SPD 6	Pin 3 : SPD 3	Pin 7 : SPD 7	Pin 4 : SPD 4	Pin 8 : SPD 8	%	100.0 0.00
Pin 1 : SPD 1	Pin 5 : SPD 5											
Pin 2 : SPD 2	Pin 6 : SPD 6											
Pin 3 : SPD 3	Pin 7 : SPD 7											
Pin 4 : SPD 4	Pin 8 : SPD 8											

* Note: In explanation of select signals, 0 stands for "0" and 1 for "1".

Table 13.5 Encoder Orientation Constants

Constant No.	Constant Name	Explanation	Unit	Upper Limit
				Lower Limit
C2-01	Load Axis Positioning Origin P_{ORG}	Mechanical origin of the load axis. Set difference from encoder origin signal (phase-C) pulses.	Pulses	4095 0
C2-02	Position Control Proportional Gain (H) K_{PH}	Position control proportional gain when high-speed gear is selected (MGR and LGR are OFF) or when high-speed winding is selected (CHW is OFF). Raising K_{PH} increases rigidity. Speed Reference (pps) = $K_{PH} \times$ Position Tolerance (pulses)	1/s	99 1
C2-03	Position Control Proportional Gain (M) K_{PM}	Position control proportional gain when medium-speed gear is selected (MGR is ON). Raising K_{PM} increases rigidity. Speed Reference (pps) = $K_{PM} \times$ Position Tolerance(pulses)	1/s	99 1
C2-04	Position Control Proportional Gain (L) K_{PL}	Position control proportional gain when low-speed gear is selected (LGR is ON) or when low-speed winding is selected (CHW is ON). Raising K_{PL} increases rigidity. Speed Reference (pps) $K_{PL} \times$ Position Tolerance (pulses)	1/s	99 1
C2-05	Speed Control Proportional Gain (H) K_{VHO}	Speed control proportional gain when high-speed gear is selected (MGR and LGR are OFF) or when high-speed winding is selected (CHW is OFF) in orientation control (ORT is ON). Torque Reference $P = K_{VHO} \times$ Speed Tolerance	%/Hz	255 1
C2-06	Speed Control Integral Time Constant (H) τ_{VHO}	Speed control integral time constant when high-speed gear is selected (MGR and LGR are OFF) or when high-speed winding is selected (CHW is OFF) in orientation control (ORT is ON). Torque Reference $I =$ Speed Tolerance \times Time / τ_{VHO}	ms	1000 5
C2-07	Speed Control Proportional Gain (M,L) K_{VLO}	Speed control proportional gain when low-speed gear is selected (MGR or LGR is ON) or when low-speed winding is selected (CHW is ON) in orientation control(ORT is ON). Torque Reference $P = K_{VLO} \times$ Speed Tolerance	%/Hz	255 1
C2-08	Speed Control Integral Time Constant (M,L) τ_{VLO}	Speed control integral time constant when low-speed gear is selected (MGR or LGR is ON) or when low-speed winding is selected (CHW is ON) in orientation control (ORT is ON). Torque Reference $I =$ Speed Tolerance \times Time / τ_{VLO}	ms	1000 5
C2-09	Positioning Completion Detection Width Z_{FIN}	Detection width for outputting completion signal when the spindle reaches near the commanded stop position. Detection width is commanded stop position $\pm Z_{FIN}$	Pulses	200 0
C2-10	Positioning Completion Cancel Width Z_{CAN}	Set value for canceling completion signal when the spindle is moved after completion signal is output. Cancel width is commanded stop position $\pm Z_{CAN}$	Pulses	200 Z_{FIN}
C2-11	Orientation Speed S_{ORT}	Speed applied (after detecting encoder origin) until changing to the servo loop during orientation	r/min	600 40
C2-12	BCD Stop Position Reference Resolution P_{BCD}	Angle set value per minimum increment of stop position BCD reference	°	180.0 0.5
C2-13	Arbitrary Stop Position Offset P_{IMG}	Stop position offset for smoothing stop operation when the servo loop is used When Z_{FIN} is reached, offset becomes 0.	Pulses	100 0

Table 13.5 Encoder Orientation Constants (Cont'd)

Constant No.	Constant Name	Explanation	Unit	Upper Limit
				Lower Limit
C2-14	Orientation Speed Change Ratio R_{SOR}	Speed change ratio for gradually reducing orientation speed to reduce gear noise when switching from orientation speed to servo loop speed		100
				0
C2-15	Starting Soft Start Time T_{SFO}	Soft start time for accelerating from at rest state to orientation speed. Use this parameter to reduce gear noise at starting Acceleration rate is (500 r/min.) /s.	ms	50
				0
C2-16	Flux Level ϕ_{ORT}	Flux level at completion of orientation. Motor noise and torque changes in proportion to flux level.		100
				15
C2-17	Orientation Speed Reduction Coefficient K_{SOR}	Reduction coefficient to set orientation speed in proportion to the angle of traveling for incremental positioning.		32767
				0
C2-18	---			
C2-19	---			
C2-20	---			
C2-21				
C2-22	Orientation Control Select Signal 1 SEL-E1*	<p>Control mode setting signal for specifying the direction of rotation in orientation control</p> <ul style="list-style-type: none"> • Bits 1 and 0: Positioning rotation direction <ul style="list-style-type: none"> 00: Automatically selected rotation direction 01: Same direction as the commanded operation direction 10: Fixed rotation direction 11: Automatically selected rotation direction • Bits 2: Selection for fixed rotation direction <ul style="list-style-type: none"> 0: Forward rotation of the spindle 1: Reverse rotation of the spindle • Bits 3: Stop position reference code <ul style="list-style-type: none"> 0: 12-bit binary 1: 3-digit BCD • Bits 4: Tune-up operation <ul style="list-style-type: none"> 0: Tune-up available 1: Tune-up unavailable • Bits 5: Incremental positioning reference point <ul style="list-style-type: none"> 0: Formerly commanded stop position 1: Present stop position • Bits 6: Encoder <ul style="list-style-type: none"> 0: Spindle encoder 1: Motor encoder • Bits 7: Rotation direction of motor and spindle <ul style="list-style-type: none"> 0: Reverse 1: The same 		---

* In explanation of select signals, 0 stands for "0" and 1 for "1".

Table 13.5 Encoder Orientation Constants (Cont'd)

Constant No.	Constant Name	Explanation	Unit	Upper Limit
				Lower Limit
C2-23	Orientation Control Select Signal 2 SEL-E2*	Dither signal pattern and gain • Bit 0: DB selection upon orientation completion 0: Invalid 1: Stops by braking torque orientation completion • Bit 1: Dither signal pattern 0: 6 steps (83Hz) 1: 2 steps (250Hz) • Bit 4, 3, and 2: Dither signal level (H) (MGR, LGR: OFF) 000: 0.0% 011: 7.5% 110: 15.0% 001: 2.5% 100: 10.0% 111: 17.5% 010: 5.0% 101: 12.5% • Bit 7, 6, and 5: Dither signal level (L) (MGR or LGR: ON) 000: 0% 011: 3% 110: 6% 001: 1% 100: 4% 111: 7% 010: 2% 101: 5%		---
C2-24	Orientation Control Select Signal 3 SEL-E3*	Orientation Control parameters • Bits 5 and 4: Speed reference differential compensation gain 00: 10 01: 15 10: 20 11: 30 • Bits 7 and 6: Flux level for positioning servo loop control 00: 100 % 01: 80 % 10: 60 % 11: 40 %		---

* In explanation of select signals, 0 stands for "0" and 1 for "1".

Table 13.6 Magnetic Sensor Orientation Constants

Constant No.	Constant Name	Explanation	Unit	Upper Limit	Lower Limit
C3-01	Load Axis Positioning Origin P_{ORG}	Mechanical origin of the load axis. Set difference from magnetic sensor signal in degrees.	°	2.00	-2.00
C3-02	Position Control Proportional Gain (H) K_{PH}	Position control proportional gain when high-speed gear is selected (MGR and LGR are OFF) or when high-speed winding is selected (CHW is OFF). Boosting K_{PH} increases rigidity. Speed Reference (pps) = $K_{PH} \times$ Position Tolerance (pulses)	1/s	99	1
C3-03	Position Control Proportional Gain (M) K_{PM}	Position control proportional gain when medium-speed gear is selected (MGR is ON). Boosting K_{PM} increases rigidity. Speed Reference (pps) = $K_{PM} \times$ Position Tolerance (pulses)	1/s	99	1
C3-04	Position Control Proportional Gain (L) K_{PL}	Position control proportional gain when low-speed gear is selected (LGR is ON) or when low-speed winding is selected (CHW is ON). Boosting K_{PL} increases rigidity. Speed Reference (pps) = $K_{PL} \times$ Position Tolerance (pulses)	1/s	99	1
C3-05	Speed Control Proportional Gain (H) K_{VHO}	Speed control proportional gain when high-speed gear is selected (MGR and LGR are OFF) or when high-speed winding is selected (CHW is OFF) in orientation control (ORT is ON). Torque Reference P = $K_{VHO} \times$ Speed Tolerance	% / Hz	255	1
C3-06	Speed Control Integral Time Constant (H) τ_{VHO}	Speed control integral time constant when high-speed gear is selected (MGR and LGR are OFF) or when high-speed winding is selected (CHW is OFF) in orientation control (ORT is ON). Torque Reference I = Speed Tolerance \times time / τ_{VHO}	ms	1000	5
C3-07	Speed Control Proportional Gain (M,L) K_{VLO}	Speed control proportional gain when low-speed gear is selected (MGR or LGR is ON) or when low-speed winding is selected (CHW is ON) in orientation control (ORT is ON). Torque Reference P = $K_{VLO} \times$ Speed Tolerance	% / Hz	255	1
C3-08	Speed Control Integral Time Constant (M,L) τ_{VLO}	Speed control integral time constant when low-speed gear is selected (MGR or LGR is ON) or when low-speed winding is selected (CHW is ON) in orientation control (ORT is ON). Torque Reference I = Speed Tolerance \times time / τ_{VLO}	ms	1000	5
C3-09	Positioning Completion Detection Width Z_{FIN}	Detection width for outputting completion signal when the load axis reaches near the commanded stop position. Detection width is commanded stop position $\pm Z_{FIN}$	°	20.0	0.0
C3-10	Positioning Completion Detection Width Z_{CAN}	Set value for canceling completion signal when the load axis is moved after completion signal is output. Cancel width is commanded at stop position $\pm Z_{CAN}$	°	20.0	Z_{FIN}
C3-11	Orientation Speed S_{ORT}	Speed applied (after detecting magnetic sensor signal) until changing to the servo loop during orientation	r/min	600	40
C3-12	BCD Stop Position Reference Resolution P_{BCD}	Completion signal cancel angle per minimum increment for determining stop position for incremental positioning with BCD command after stopping at home position.	°	180.0	0.5
C3-13	Arbitrary Stop Position Offset P_{IMG}	Stop position offset for smoothing stop operation when the servo loop is used When Z_{FIN} is reached, offset becomes 0.	°	10.0	0

Table 13.6 Magnetic Sensor Orientation Constants (Cont'd)

Constant No.	Constant Name	Explanation	Unit	Upper Limit
				Lower Limit
C3-14	Orientation Speed Change Ratio	Speed change ratio for gradually reducing orientation speed to reduce gear noise when switching from orientation speed to servo loop speed		100
				0
C3-15	Starting Soft Start Time T_{SFO}	Soft start time for accelerating from stop to orientation speed. Use this parameter to reduce gear noise at starting. Acceleration rate is (500 r/min) / s.	ms	50
				0
C3-16	Flux Level ϕ_{ORT}	Flux level at completion of orientation. Motor noise and torque change in proportion to flux level.		100
				15
C3-17	Orientation Speed Reduction Coefficient K_{SOR}	Reduction coefficient to set orientation speed in proportion to the traveling angle for incremental positioning.		32767
				0
C3-18	-----			
C3-19	-----			
C3-20	Sensor Signal Standardization Angle θ_{CEN}	Angle for standardizing magnetic sensor signal detection sensitivity $\theta_{SEN} = 180^\circ \times \text{Detection Range (mm)} \div \text{Mounting Radius} \div \pi$ Set 20.0 to θ_{SEN} when $\theta_{SEN} > 20.0$. For detection range, check the specifications of the magnet and apply the values below: MG-1378BS (15mm) MG-1444S (7mm)	°	20.0
				5.0
C3-21	-----			
C3-22	Orientation Control Select Signal 1 SEL-M1*	Control mode setting signal for specifying the direction of rotation in orientation control • Bits 1 and 0 : Positioning rotation direction 00 : Automatically selected rotation direction 01 : Same direction as the commanded forward/reverse rotation direction 10 : Fixed rotation direction 11 : Automatically selected rotation direction • Bits 2 : Selection for fixed rotation direction 0 : Forward rotation of the spindle 1 : Reverse rotation of the spindle • Bits 3 : Stop position reference code 0 : 12-bit binary 1 : 3-digit BCD • Bits 4 : Tune-up operation 0 : Tune-up possible 1 : Tune-up not possible • Bits 5 : Incremental positioning reference point 0 : Formerly commanded stop position 1 : Present stop position • Bits 6 : Encoder 0 : Spindle encoder 1 : Motor encoder • Bits 7 : Rotation direction of motor and spindle 0 : Reverse 1 : The same		---

* In explanation of select signals, 0 stands for "0" and 1 for "1."

Table 13.6 Magnetic Sensor Orientation Constants (Cont'd)

Constant No.	Constant Name	Explanation	Unit	Upper Limit
				Lower Limit
C3-23	Orientation Control Select Signal 2 SEL-M2*	<p>Dither signal pattern and gain</p> <ul style="list-style-type: none"> • Bit 1 : Dither signal pattern 0 : 6 steps (83 Hz) 1 : 2 steps (250 Hz) • Bit 4, 3, and 2 : Dither signal level (H) 000 : 0.0% 011 : 7.5% 110 : 15.0% 001 : 2.5% 100 : 10.0% 111 : 17.5% 010 : 5.0% 101 : 12.5% • Bit 7, 6, and 5 : Dither signal level (L) 000 : 0% 011 : 3% 110 : 6% 001 : 1% 100 : 4% 111 : 7% 010 : 2% 101 : 5% 		---
C3-24	Orientation Control Select Signal 3 SEL-M3*	<p>Orientation control parameters</p> <ul style="list-style-type: none"> • Bit 5 and 4 : Speed reference differential compensation gain 00 : 10 01 : 15 10 : 20 11 : 30 • Bit 7 and 6 : Flux level for positioning servo loop control 00 : 100% 01 : 80% 10 : 60% 11 : 40% <p> Email: service@repairtw.com Line id: @zzzz </p>		---

* In explanation of select signals, 0 stands for "0" and 1 for "1".
www.repairtw.com

13.5 PROTECTIVE FUNCTION DISPLAY

If an error occurs during operation, protective functions are activated depending on the failure and operation is stopped. The activated protective functions are indicated on the digital operator in F codes.

Failure codes are output as signals to pins 23 to 27 of 1CN as shown in Fig. 13.3. In the figure, ○ indicates ON and ● indicates OFF.

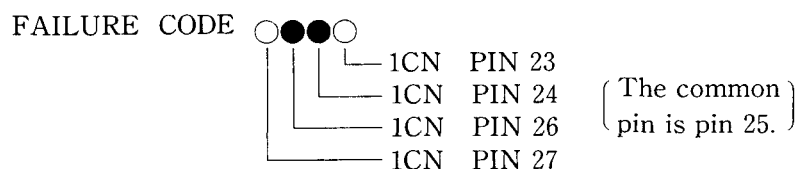

Fig. 13.3 Failure Code Output

Table 13.7 Protective Functions

F Code No.	Protective Function	Explanation	Failure
F-000	Winding Selection Failure	Windings were not selected within set time.	●●●●
F-001	Emergency Stop Failure	Operation was not stopped within 10 seconds after emergency stop was commanded.	●●●●
F-100	Inverter Output Overcurrent	Output current exceeded set overcurrent value.	●●●○
F-200	Inverter Internal MC Operation Failure	The magnetic contactor in the input block is not functioning.	●●○●
F-201	MCCB Trip	The MCCB in the input block tripped.	●●○●
F-300	Inverter Input Overcurrent	Input current exceeded set overcurrent value.	●●○●
F-400	Inverter Overvoltage	Inverter DC bus voltage exceeded set overvoltage value.	●○●●
F-500	Motor Overspeed	Motor speed exceeded 120% of max. set speed.	●○●○
F-600	Power Voltage Error 1	Synchronous power signal is lost (at power-ON).	●○●●
F-601	Power Frequency Error 1	Whether 50 Hz or 60 Hz cannot be determined (at power-ON).	●○●●
F-602	Power Voltage Error 2	Low-voltage (85% or lower), momentary power loss (for 0.02 second or longer), or open phase	●○●●
F-603	Power Frequency Error 2	Excess power frequency deviations (Deviation is 5% of the frequency or greater.)	●○●●
F-604	Power Voltage Error 3	Low-voltage of control power source (175 VAC or lower) or power loss	●○●●
F-700	Inverter Output Overload	Output current of 120% of 30-minute rating flowed for one minute or longer.	●○○○
F-701	Inverter Input Overload	Input current of 120% of 30-minute rating flowed for one minute or longer.	●○○○
F-800	Excess Speed Deviation	Speed rose to 120% of commanded value or greater, or dropped to 50% or lower.	○●●●
F-900	Motor Thermal Error 1	Motor temperature exceeded upper limit. (Minor failure)	●●●●
F-901	Motor Thermal Error 2	Motor Temperature over upper limit continued for four minutes or longer.	○●●○
F-902	Motor Thermal Error 3	Break in wire occurred in the motor temperature detection thermistor. (Detected at -10°C or less)	○●●○
F-903	Heat Sink Thermal Error 1	Heat sink temperature exceeded upper limit. (minor failure)	●●●●
F-904	Heat Sink Thermal Error 2	Heat sink temperature over upper limit continued for one minute or longer.	○●●○
F-905	Heat Sink Thermal Error 3	Break in wire occurred in the heat sink temperature detection thermistor. (Detected at -10°C or less)	○●●○
F-906	Control Panel Thermal Error 1	Panel internal temperature exceeded +55°C (minor failure)	●●●●
F-907	Control Panel Thermal Error 2	Panel internal temperature exceeded +60°C	○●●○

Table 13.7 Protective Functions (Cont'd)

F Code No.	Protective Function	Explanation	Failure Code
F-A00	Initial Charge Failure 1	Charging for the main capacitor did not complete.	○●○○●
F-b00	Controller Failure 1	Failure of the speed instruction AD converter	○●○○○
F-b01	Controller Failure 2	Failure of the AD converter with CPU	○●○○○
F-b02	Controller Failure 3	Failure of the Phase-U current detection AD converter	○●○○○
F-b03	Controller Failure 4	Failure of the Phase-W current detection AD converter	○●○○○
F-C00	Break in Speed Detection Signal Cable	Break in wire or misconnection of the motor encoder signal cable	○○●●●
F-d00	Controller Failure 5	Memory (PROM) failure	○○●○○
F-d01	Software Version Mismatch	Controller mismatched software version.	○○●○○
F-d11	Position Detector Failure 1	<ul style="list-style-type: none"> Phase C was not detected when tuning up. (Encoder method orientation) Sensor Signal was not detected when tuning up. (Magnetic sensor method orientation) 	○○●○○
F-d12	Position Detector Failure 2	Phase-C signal exceeded 100 pulses when tuning up.	○○●○○
F-d13	Position Detector Failure 3	<ul style="list-style-type: none"> Pulses per rotation exceeded 4096 ± 1 when tuning up. (Encoder method orientation) Detection error of one rotation of shaft exceeded $\pm 22.5^\circ$. (Magnetic sensor method orientation) 	○○●○○
F-d14	Tune-up Incomplete	Orientation command was input before tuning up.	●●●●●
F-d15	INC Signal Error	Incremental signal timing error of INC signal	●●●●●
F-d16	Break in Position Detection Signal Cable	Break in wire or misconnection of the position detection encoder signal cable.	○○●○○
F-d17	Break in Magnetic Sensor Signal Cable	Break in wire or misconnection of the magnetic sensor signal cable	○○●○○
F-d18	Orientation Card Unmatch	Unmatch between orientation selection (C1-39) and orientation card	○○●○○
F-E00	Controller Failure 6	Memory (NVRAM) failure	○○○●●
F-E01	Controller Failure 7	Memory (NVRAM) failure	○○○●●
F-E02	Controller Failure 8	Data in memory (NVRAM) exceeded upper or lower limit.	○○○●●
F-E03	Controller Failure 9	Memory (NVRAM) failure	○○○●●
F-E04	Motor Code Selection Error	Selected motor code did not match the unit.	○○○●●
F-F00	I/O Error 1	Inter-CPU data transfer error	○○○○○
F-F03	I/O Error 2	Inter-CPU data transfer error	○○○○○
CPF00	CPU Failure 1	Internal memory (RAM) failure or WDT activation	-----
CPF01	CPU Failure 2	Excessive time error	-----

14. DRY RUN

- ⚠ - Precautions before turning power ON

Before turning power ON, do the following:

- (1) Verify there is no physical obstacle to operation.
- (2) Notify people in the adjacent area before starting.

Turn ON power to the drive system after confirming security around the machines.

14.1 CHECK AFTER TURNING ON POWER

After power is turned ON, LEDs on the digital operator of the inverter light and the cooling fans of the motor and the inverter start rotation. Check the system as follows:

14.1.1 Checking the Motor

Verify that cooling air for the motor flows in the direction shown in Fig. 14.1.

According to the standard specifications, cooling air is taken in from the drive end and exhausted from the opposite drive end. If the flow direction is reversed, contact your YASKAWA representative.

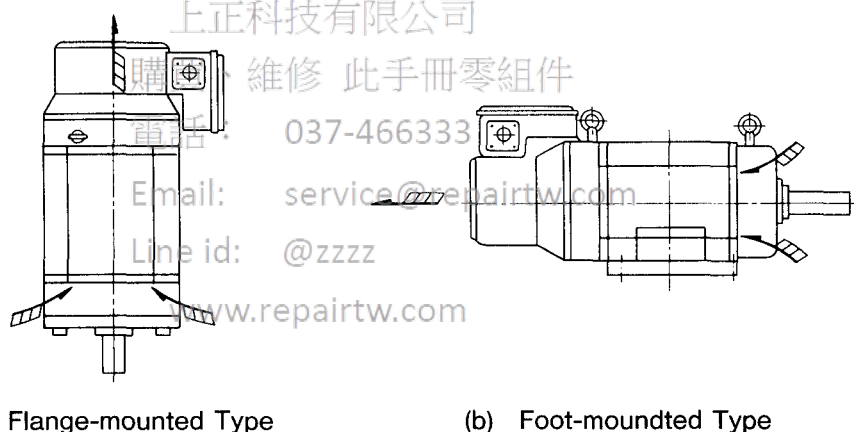

Fig. 14.1 Motor Cooling Air Passage

14.1.2 Checking the Inverter

After power is turned ON, all the LEDs on the digital operator light, then ROM number is displayed, and finally motor speed (V1-01) is displayed as described in Par. 13.2.1, "Indication at Power-ON."

If emergency stop signal (EMG) is connected, "CHARGE" lights brightly in red. If error indication is displayed or "CHARGE" is OFF, investigate the cause according to Sect. 16, "Troubleshooting."

14.1.3 Checking Status Display

Status of the drive system including the inverter and the motor can be checked by monitoring the contents of V1-01 to V1-18 using the operation status display function.

After power is turned ON, motor speed (V1-01) is displayed. Check other status indications with Table 4.2.

14.2 SETTING UP CONSTANTS

The inverter is set up and adjusted at the factory to fit the combined motor. As a rule, customers do not need to adjust the inverter. If setting must be modified because of changes of operation specifications, control constants can be changed. See Sect. 13, "Operation of the Digital Operator" and change the setting.

In the following, control constants are explained in the order of arrangement; however, they do not need to be set up in that order. Skip control constants that do not need to be changed.

14.2.1 Soft Start Time Setup (T_{SFS} : C1-10)

This constant specifies the duration of changing inverter speed from 0 r/min. to the rated speed or vice versa. Fig. 14.2 shows the relation between reference and the duration. Soft start time can be set up from 0.1 to 180.0 seconds.

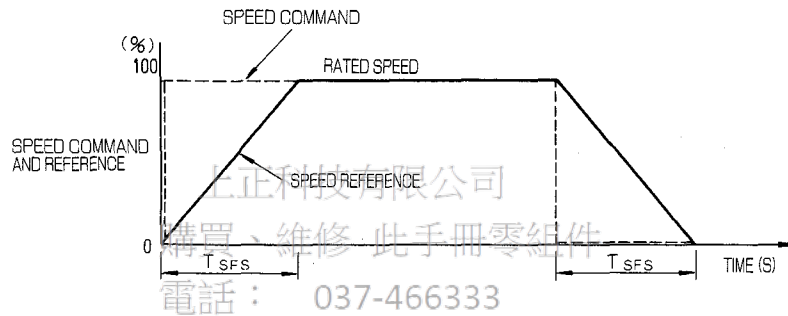

Fig. 14.2 Soft Start Time Setting

14.2.2 Load Meter Full-Scale (LM_{FSC} : C1-18)

During operation, the load ratio meter indicates the ratio of output to motor rated output in percent. Set full-scale value (expressed as a percent of the motor continuous rating) of the load meter for control constant C1-18. 120% to 350% can be set.

14.2.3 Zero-speed Detection Level (ZS_{LVL} : C1-19)

This constant sets the detection level for zero-speed signal. Standard value is 30 r/min. It is possible to set 3 r/min. to 60 r/min. The operating point has a hysteresis of ± 2 r/min. as shown in Fig. 14.3.

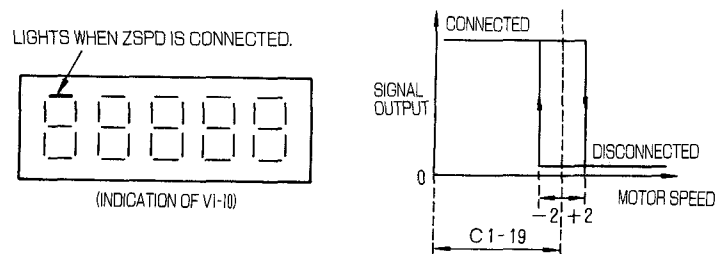

Fig. 14.3 Zero-speed Signal Detection Level and Operation Indication

14.2.4 Speed Agree Width (AGR_{BD}: C1-20)

This constant sets the operating level for speed agree signal AGR (connected when speeds agree). Range of speed agree can be set from 10% to 50%. Standard value is 15%.

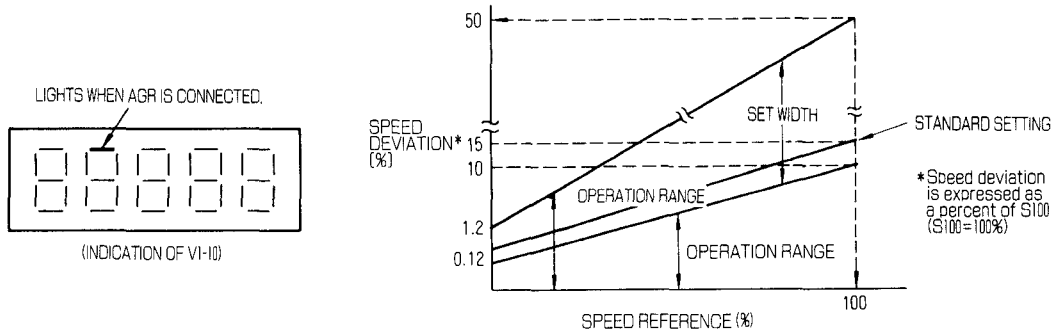

Fig. 14.4 Speed Agree Width Setting and Operation Indication

14.2.5 Speed Detection Level (SD_{LVL}: C1-21, SD_{HYS}: C1-22)

If motor speed is reduced to or below any of these constants, output signal SDET is connected. Fig. 14.5 shows indication of operation status display V1-10 of the digital operator then. Speed detection level can be set from 0% to 100%. Hysteresis width can be set from 0% to 10%.

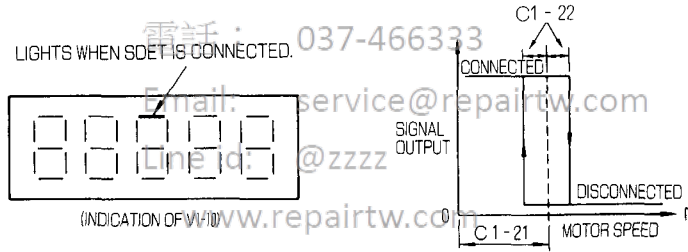

Fig. 14.5 Speed Detection Level and Operation Indication

14.2.6 Torque Detection Level (TD_{LVL}: C1-23)

This constant sets the operation level for torque detection signal TDET. (When torque is reduced to or below the set level, TDET is connected.) Fig. 14.6 shows operation status display V1-10 of the digital operator when TDET is connected. Torque detection level is expressed as a percent of 30-minute rated torque and can be set from 5% to 120%. Operating point has a hysteresis of $\pm 10\%$ as shown in Fig. 14.6.

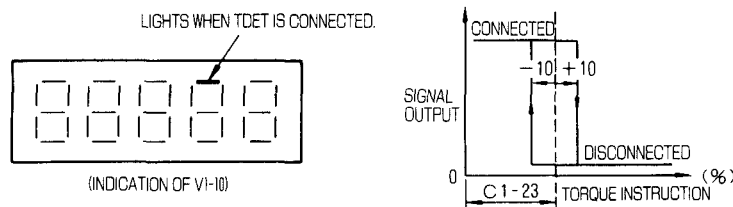



Fig. 14.6 Torque Detection Signal Operation Level and Operation Indication

14.2.7 External Operation Torque Limiting Level (TL_{EXT}: C1-24)

This control constant is used for external torque limiting. The constant is expressed as a percent of 30-minute rated torque and can be set from 5% to 120%.

14.2.8 Motor Code Selection (MTR: C1-25)

The motor code is a label of the motor control constant stored in the inverter memory. Table 14.1 lists motor codes. Before altering the set motor code, verify that the inverter unit capacity is matched. If the selected motor code does not match the inverter capacity, failure indication F-E04 lights.

 - Precautions on changing motor code

After changing the motor code, turn OFF power and verify that the indications on the digital operator go OFF, then turn ON power again.
Without the above procedure, changed motor code is invalid.

Table 14.1 Motor Codes

Motor Capacity kW (HP) (30-minute rating/ continuous rating)	200V Standard Series	400V Standard Series	200V Winding Selection Series	400V Winding Selection Series
3.7 / 2.2 (5 / 3)	24	81	—	—
5.5 / 3.7 (7.5 / 5)	02	82	32	B2
7.5 / 11 (10 / 15)	03	83	33	B3
11 / 7.5 (15 / 10)	04	84	34(3B) ^{Note 1}	B4(BB) ^{Note 2}
15 / 11 (20 / 15)	05	85	35	B5
18.5 / 15 (25 / 20)	06	86	36	B6
22 / 18.5 (30 / 25)	07	87	37	B7
30 / 22 (40 / 30)	09	88	—	—
37 / 30 (50 / 40)	0A	8A	—	—

Notes: 1. 3B is for flange-mounted type, model is UAASKD-11CZ1.
2. BB is for flange-mounted type, model is UAASKD-11CZ1* *E.

14.2.9 Rated Speed (S₁₀₀: C1-26)

Set up rated speed according to mechanical specifications. The motor runs at the rated speed when speed reference of 100% is input.

Rated speed can be set from 100 r/min to the motor maximum speed.

14.2.10 Transmission Ratio (R_{HGR}: C1-27, R_{MGR}: C1-28, R_{LGR}: C1-29)

These constants set the transmission ratio of spindle to motor shaft which is determined by mechanical specifications.

Transmission ratio (spindle speed/motor speed) can be set from 0.05 to 2.5. When you set an exact value the ratio affects the orientation control characteristics.

14.2.11 Flux and Base Speed Ratio in Servo Mode (ϕ_{SVH} : C1-31, R_{BSH} : C1-32,
 ϕ_{SVL} : C1-33, R_{BSL} : C1-34)

These control constants are used to extend constant torque control range for solid tapping. Set the flux levels (C1-31 and C1-33) and the base speed ratios (C1-32 and C1-34) in relation to each other as shown in Fig. 14.7.

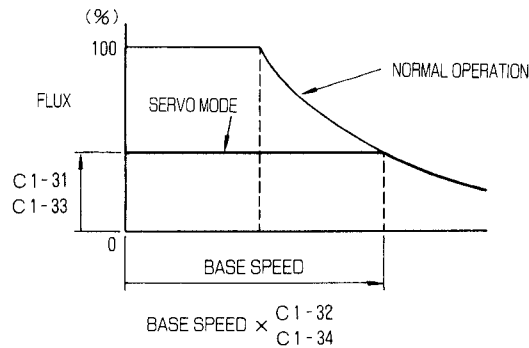

Fig. 14.7 Flux Level in Servo Mode

14.2.12 Positioning Completion Detection Width (Z_{FIN} : C2-09, C3-09) and
 Positioning Completion Cancel Width (Z_{CAN} : C2-10, C3-10)

These constants must be set up while the system is stopped. Orientation completion signal is connected when the difference between the commanded and actual stop positions is within the completion detection width continuously for 60 ms or longer. If the difference exceeds the completion cancel width after the completion signal is output, the completion signal is immediately disconnected. Both completion detection width and completion cancel width can be set from 0 (0°) to 200 (17.6°) in encoder orientation control, and from 0.0° to 20.0° in magnetic sensor orientation control. Completion cancel width must not be smaller than completion detection width. If a value greater than completion cancel width is set for completion detection width after setting the cancel width, the completion detection width value is automatically set for the cancel width.

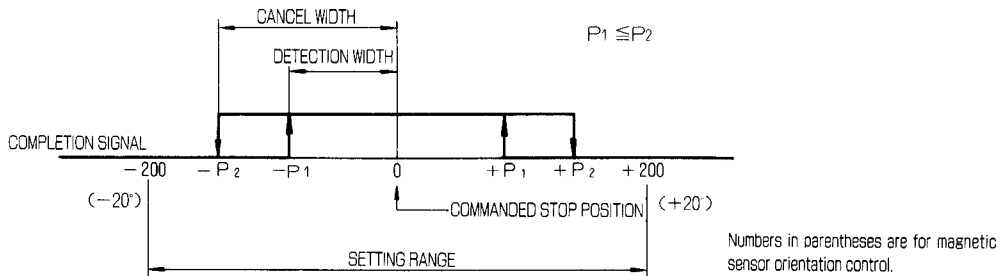

Fig. 14.8 Completion Signal Detection Position

14.2.13 Orientation Speed (S_{ORT}: C2-11, C3-11)

Orientation speed must be set up while the system is stopped.

Orientation speed is determined by inertial momentum (including motor shaft) and torque.

Calculate for each machine the spindle inertial momentum and the spindle torque required when high-speed gear is used, then obtain orientation speed from Fig. 14.9. The value is the upper limit, so lower setting is possible.

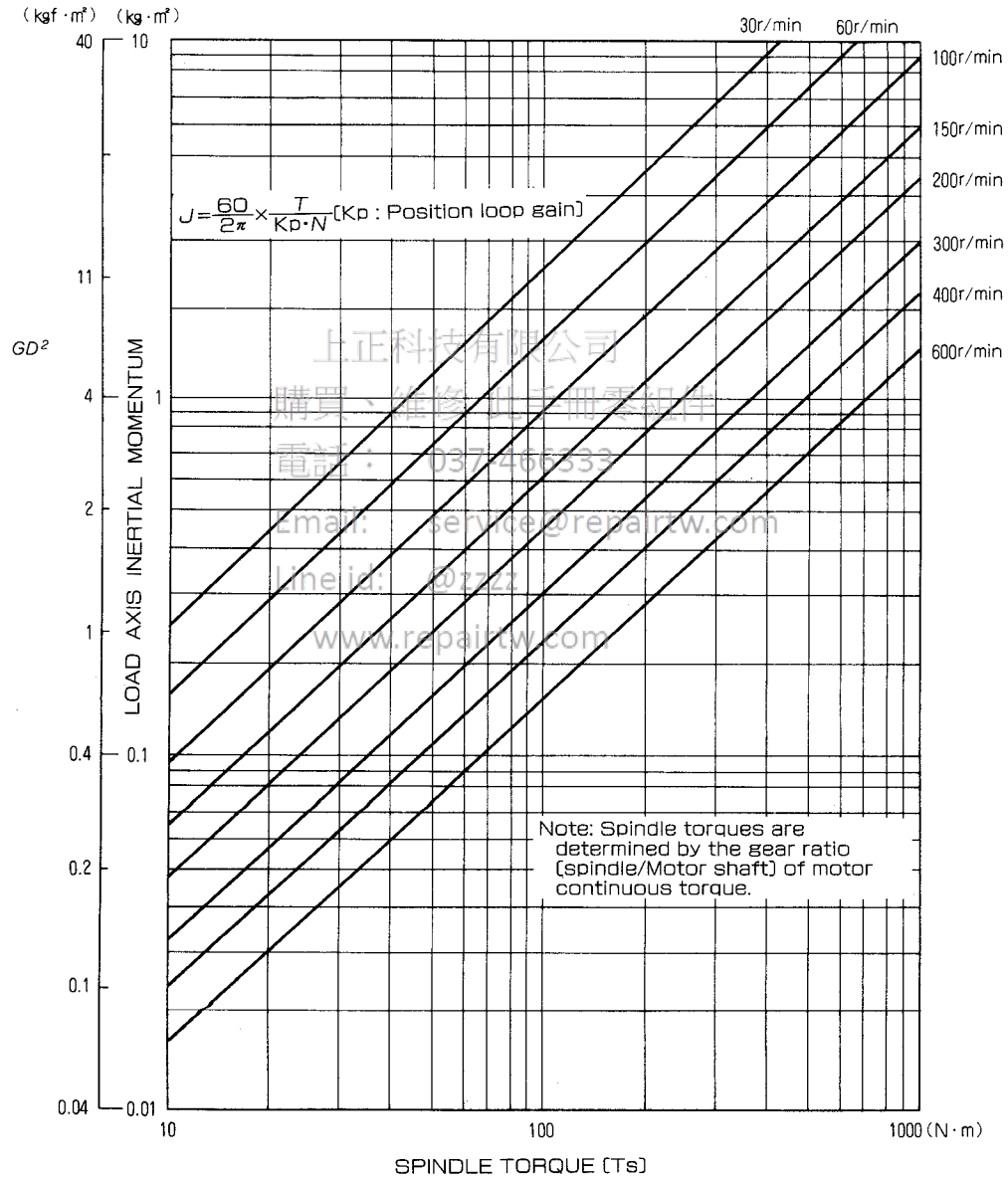

Fig. 14.9 Orientation Speed Setting

14.2.14 Resolution of BCD Stop Position Reference (P_{BCD}: C2-12, C3-12)

This setting must be performed while the system is stopped.

The resolution can be set from 0.5° to 180.0°. Stop position reference must be within $\pm 360^\circ$. For example, when resolution is set to 90°, stop position reference "1" translates into 90°, "2" into 180°, "4" into 0°, and "5" again into 90°.

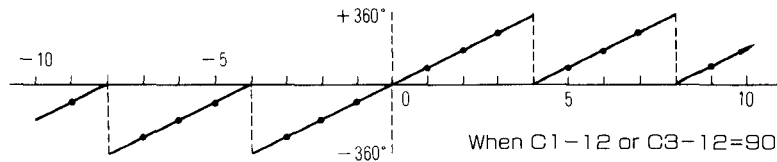

Fig. 14.10 Stop Position Reference and Stop Position

14.3 OPERATION

After checking, input operation signal to start operation. Gradually raise speed reference from 0%. The motor starts rotation.

Verify that the motor turns in the proper direction. When forward run is commanded (by FWD) and speed reference is positive, the motor shaft turns counterclockwise (CCW) when viewed from the load machine. If the rotation direction is reversed, or if the motor does not turn but only buzzes or vibrates after the operation signal is input, phases of the power cable or encoder signal wire may be connected wrong. Turn OFF power and check wiring.

When the motor turns in the proper direction, change speed reference or switch forward and reverse run and verify that acceleration and deceleration are smooth in both forward and reverse directions.

At the same time, check for excessive motor vibration or noise. Stationary sound at several kilohertz is due to the control method and do not indicate any abnormality.

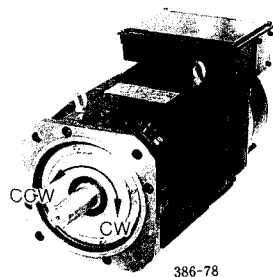

Fig. 14.11 Motor Rotation Direction

Speed Command	⊕	⊖
Operation	FWD	REV
Signal	CCW	CW

⚠ Precautions on operation

- (1) Verify that the motor stands still before starting. Starting during coasting-to-stop may activate overvoltage protection (F400) or overcurrent protection (F100).
- (2) Do not turn ON the MCCB in the inverter after turning ON power. Turn ON MCCB in the inverter before turning ON power. Otherwise, the main capacitor charging current may damage the components.
- (3) Do not change the wiring or connect/disconnect the wire during current conduction.

14.4 ADJUSTMENT PROCEDURE AND CONTROL CONSTANT SETUP

After verifying that the motor operates normally, adjust the speed control mode and position control mode for orientation control according to the adjustment procedures. The following adjustment must also be performed after replacing the motor, inverter, magnetic sensor or encoder.

14.4.1 Adjustment in Speed Control Mode

Refer to the following flow chart for adjustment.

Adjusting Item and Procedure	Content
	<p>Operation control (with 0-V common)</p> <p>Input signal check</p> <ul style="list-style-type: none"> • Input signal status (VI-09) <p>RDY, EMG, and FWD light.</p> <p>Speed reference adjustment range (C1-12)</p> <p>C1-12 = Commanded Motor Speed / Actual Speed</p> <p>〈Example〉 When 6000r/min is commanded and actual speed is 6060 r/min, $C1-12 = 6000 / 6060 = 0.99$</p>

(Cont'd)

Adjusting Item and Procedure	Content																				
<pre> graph TD Start(()) --> Q1{Are indications on the speedometer correct?} Q1 -- YES --> Q2{Are indications on the speedometer higher than actual motor speed?} Q1 -- NO --> Q2 Q2 -- YES --> A1[Make C1-16 (SM_{adj}) smaller than present value.] Q2 -- NO --> A2[Make C1-16 (SM_{adj}) greater than present value.] A1 --> Q2 A2 --> Q2 Q2 --> P1[Turn forward run signal (FWD) ON and OFF to accelerate and decelerate the motor.] P1 --> Q3{Are indications on the load factor meter correct in accel/decel?} Q3 -- YES --> P2[Turn forward run signal ON to stop the motor.] Q3 -- NO --> P2 P2 --> D1[Display C1-17 data on the digital operator.] D1 --> P3[Depress the DATA ENTER key and the > RESET key simultaneously.] P3 --> P4[Turn forward run signal ON to stop the motor.] P4 --> Q4{Are indications on the load factor meter higher than the actual figure?} Q4 -- YES --> A3[Make C1-17 (LM_{adj}) smaller than present value.] Q4 -- NO --> A4[Make C1-17 (LM_{adj}) greater than present value.] A3 --> Q4 A4 --> Q4 Q4 --> P5[Depress the DSPL key to return to the initial status.] P5 --> P6[Depress the Δ key.] P6 --> End((Adjustment end)) </pre>	<p>Speedometer Adjustment Range (C1-16)</p> <p>(P.U.)</p> <p>SPEEDOMETER SIGNAL</p> <p>0 0.9 1.0 1.5 (C1-16)</p> <p>C1-16 = actual motor speed / indication on speedometer <Example> When motor speed is 6000 r/min and indication on the speedometer is 5940 r/min. $C1-16 = 6000 / 5940 = 1.01$</p> <p>Maximum Indication on the Load Factor Meter (12% of 30-minute rating)</p> <p>Maximum Indication on the Load Factor Meter</p> <table border="1"> <thead> <tr> <th>Capacity</th> <th>LM</th> <th>Capacity</th> <th>LM</th> </tr> </thead> <tbody> <tr> <td>3.7 / 2.2</td> <td>202 %</td> <td>15 / 11</td> <td>164 %</td> </tr> <tr> <td>5.5 / 3.7</td> <td>178 %</td> <td>18.5 / 15</td> <td>148 %</td> </tr> <tr> <td>7.5 / 5.5</td> <td>164 %</td> <td>22 / 18.5</td> <td>143 %</td> </tr> <tr> <td>11 / 7.5</td> <td>176 %</td> <td>30 / 22</td> <td>164 %</td> </tr> </tbody> </table> <p>Signal Output for Load Factor Meter Adjustment</p> <p>LOAD FACTOR METER SIGNAL LM</p> <p>0 V</p> <p>SIGNAL OF 120% OF 30-MINUTE RATING*</p> <p>DATA ENTER, > RESET, DSPL</p> <p>* Signal of 100% of continuous rating is output when bit 7 of C1-38 is changed to "1".</p> <p>Load Factor Meter Adjustment Range (C1-17)</p> <p>(P.U.)</p> <p>LOAD FACTOR METER SIGNAL</p> <p>0 0.9 1.0 1.5 (C1-17)</p> <p>C1-17 = (120% of 30-minute rating) / indication on the load factor meter <Example> When capacity is 7.5 kW / 5.5 kW and indication on the load factor meter is 150%. $C1-17 = 164 / 150 = 1.09$</p>	Capacity	LM	Capacity	LM	3.7 / 2.2	202 %	15 / 11	164 %	5.5 / 3.7	178 %	18.5 / 15	148 %	7.5 / 5.5	164 %	22 / 18.5	143 %	11 / 7.5	176 %	30 / 22	164 %
Capacity	LM	Capacity	LM																		
3.7 / 2.2	202 %	15 / 11	164 %																		
5.5 / 3.7	178 %	18.5 / 15	148 %																		
7.5 / 5.5	164 %	22 / 18.5	143 %																		
11 / 7.5	176 %	30 / 22	164 %																		

14.4.2 Adjustment in Encoder Orientation Control Mode

Adjust the system according to the flowchart below.



Adjusting Item and Procedure	Content
<pre> graph TD A[Turn on power switch.] --> B[Initial setting.] B --> C{Setting of gear ratio correct?} C -- NO --> D[Correct controller gear ratio and constant.] D --> C C -- YES --> E[Select H-gear.] E --> F[Turn orientation signal (ORT) ON.] F --> G[Tune-up incomplete error 'F-d14' is displayed.] G --> H[Depress the STOP and RESET keys simultaneously.] H --> I{Turn the motor in forward and reverse directions to return the spindle to the home position. Did the axis stop at the home position?} I -- NO --> J[Adjust according to troubleshooting method.] I -- YES --> K[Select control constant display of spindle positioning origin (C2-01).] K --> L[Set positioning origin data, then depress the ENTER key.] L --> M[The spindle stops at the new origin.] M --> N{Is stop position correct?} N -- NO --> J N -- YES --> O[Turn orientation signal (ORT) OFF.] O --> P[Tune-up completed.] </pre>	<p>Initial setting: Changing constants with the digital operator</p> <ul style="list-style-type: none"> • Set orientation selection (bit 0) of selection signal 4 (C1-39) to "1". • Set tune-up operation selection (bit 4) of orientation select signal 1 (C2-22) to "1". <p>Gear ratio constant</p> <ul style="list-style-type: none"> • C1-27.....H-gear ratio • C1-28.....M-gear ratio • C1-29.....L-gear ratio <p>0.050 to 2.500</p> <ul style="list-style-type: none"> • When gear ratio was selected, the changed constant is effective with turning off and on the power. <p>Identifying input signal</p> <ul style="list-style-type: none"> • Interface input status (V1-09) <p>ORIENTATION SIGNAL: ON</p> <p>Tune-up operation</p> <p>Note: Orientation completion signal (ORE) is not output at tune-up.</p> <p>Spindle positioning origin</p> <p>(IN CASE $0 < P_1 < P_2 < P_3$)</p> <ul style="list-style-type: none"> • In case of abnormality during tune-up, carry out tune-up operations once again, after resetting. <p>Set tune-up operation selection (C2-22, bit 4) to "1"</p>

(Cont'd)

Adjusting Item and Procedure	Content
	<p>Adjusting control constant Adjustment of arbitrary stop position offset (C2-13)</p> <ul style="list-style-type: none"> Adjust so that the final positioning is not too long or overshoots. <ul style="list-style-type: none"> Identify the characteristics from H-, M-, and L-gear, because the characteristics vary with load inertia. <p>Selection of H-gear Adjusting proportional gain (C2-02)</p> <ul style="list-style-type: none"> If ORE is not output in the region near the stop position, increase the gain. If the spindle is unstable even if ORE is output, reduce the gain. <p>Identifying selection of M-gear</p> <ul style="list-style-type: none"> Interface input state (V1-09) <p>Lights when M-gear is selected.</p> <p>Adjusting proportional gain (C2-03)</p> <ul style="list-style-type: none"> If ORE is not output in the region near the stop position, increase the gain. If the spindle is unstable even if ORE is output, reduce the gain. <p>Note : If L-gear selection is not covered by equipment specifications, omit adjustment.</p> <p>Identifying selection of L-gear</p> <ul style="list-style-type: none"> Interface input state (V1-09) <p>Lights when L-gear is selected.</p> <p>Adjusting proportional gain (C2-04)</p> <ul style="list-style-type: none"> If ORE is not output in the region near the stop position, increase the gain. If the spindle is unstable even if ORE is output, reduce the gain.

14.4.3 Adjustment in Magnetic Sensor Orientation Control Mode

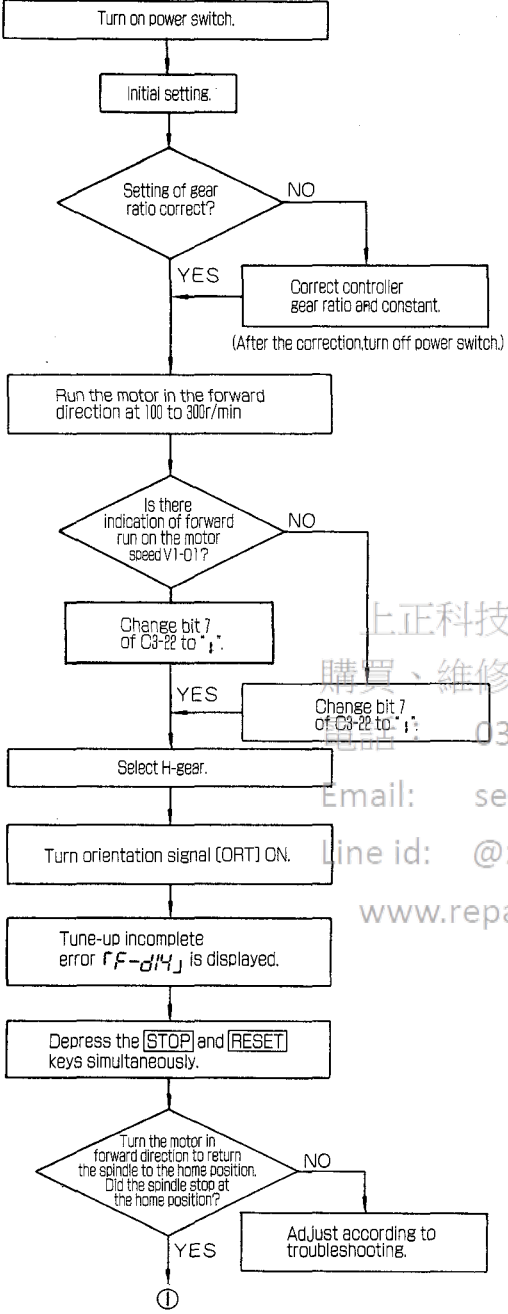
Adjust the system according to the flow chart below.

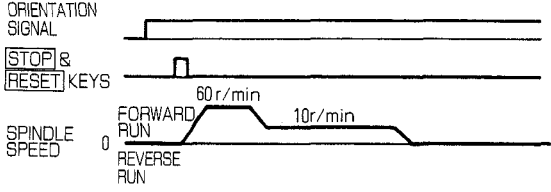
Adjusting Item and Procedure	Content
 <pre> graph TD A[Turn on power switch.] --> B[Initial settings.] B --> C{Setting of gear ratio correct?} C -- NO --> D[Correct controller gear ratio and constant.] D --> C C -- YES --> E[Run the motor in the forward direction at 100 to 300r/min] E --> F{Is there indication of forward run on the motor speed V1-D1?} F -- NO --> G[Change bit 7 of C3-22 to '1'.] G --> F F -- YES --> G G --> H[Select H-gear.] H --> I[Turn orientation signal (ORT) ON.] I --> J[Tune-up incomplete error FF-d14j is displayed.] J --> K[Depress the STOP and RESET keys simultaneously.] K --> L{Turn the motor in forward direction to return the spindle to the home position. Did the spindle stop at the home position?} L -- NO --> M[Adjust according to troubleshooting.] L -- YES --> N((1)) </pre>	<p>Initial setting: Changing constants with the digital operator</p> <ul style="list-style-type: none"> • Set orientation selection (bit 0) of selection signal 4 (C1-39) to "1". • Set standardized angle of sensor signal (C3-20). • Set tune-up operation selection (bit 4) of orientation select signal 1 (C3-22) to "1". <p>Gear ratio constant</p> <ul style="list-style-type: none"> • C1-27.....H-gear ratio • C1-28.....M-gear ratio • C1-29.....L-gear ratio <p>0.050 to 2.500</p> <ul style="list-style-type: none"> • When gear ratio was selected, the changed constant is effective by turning the power OFF and ON the power. <p>Identifying input signal</p> <ul style="list-style-type: none"> • Interface input status  <p>Tune-up operation</p>  <p>Note: Orientation completion signal (ORE) is not output at tune-up.</p>

(Cont'd)

Adjusting Item and Procedure	Content
<p>①</p> <p>②</p>	<p>Spindle positioning origin</p> <p>ORIENTATION SIGNAL</p> <p>ORIGIN DATA (IN CASE $0 < P_1 < P_2 < P_3$)</p> <p>ENTER KEY</p> <p>SPINDLE SPEED SETTING</p> <p>SPINDLE STOP POSITION</p> <ul style="list-style-type: none"> In case of abnormality during tune-up, carry out tune-up operations once again, after resetting. Set tune-up operation selection (C3-22, bit 4) to "1". <p>Adjusting control constant</p> <p>Adjustment of arbitrary stop position offset (C3-13)</p> <ul style="list-style-type: none"> Adjust so that the final positioning is not slow and that there is no overshoot. <p>LARGE OFFSET</p> <p>SMALL OFFSET</p> <p>STOP POSITION</p> <p>TIME</p> <ul style="list-style-type: none"> Identify the characteristics from H-, M-, and L-gear, because the characteristics vary with load inertia. <p>H-Gear Selection</p> <p>Adjusting proportional gain (C3-02)</p> <ul style="list-style-type: none"> If [ORE] is not output in the region near the stop position, increase the gain. If the spindle is unstable even if [ORE] is output, reduce the gain. <p>Identifying selection of M-gear</p> <ul style="list-style-type: none"> Interface input state (V1-09) <p>Lights when M-gear is selected.</p>

上正科技有限公司
 購買、維修 此手冊零組件
 電話： 037-464339
 Email: service@repairtw.com
 Line id: @zzzz

(Cont'd)

Adjusting Item and Procedure	Content
<pre>graph TD Start((2)) --> A[Turn orientation signal ON.] A --> B{Is positional accuracy insufficient or is hunting condition present?} B -- YES --> C[Adjust position control proportional gain (C3-03)] C --> B B -- NO --> D[Turn orientation signal (ORT) ON.] D --> E[Select L-gear.] E --> F[Turn orientation signal (ORT) ON.] F --> G{Is positional accuracy insufficient or is hunting condition present?} G -- YES --> H[Adjust position control proportional gain (C3-04)] H --> G G -- NO --> I[Turn orientation signal OFF.] I --> J[End of adjustment]</pre>	<p>Adjusting proportional gain (C3-03)</p> <ul style="list-style-type: none">• If ORE is not output in the region near the stop position, increase the gain.• If the load shaft is unstable even if ORE is output, reduce the gain. <p>Note: If L-gear selection is not covered by equipment specifications, omit adjustment.</p> <p>Identifying selection of L-gear</p> <ul style="list-style-type: none">• Interface input state (V1-09) <p>Lights when L-gear is selected.</p> <p>Adjusting proportional gain (C3-04)</p> <ul style="list-style-type: none">• If ORE is not output in the region near the stop position, increase the gain.• If the spindle is unstable even if ORE is output, reduce the gain.

Maintenance Manual

-  - Warning for electric shock

When checking VS-626VM3, never touch the inside until at least five minutes after power is turned OFF. Verify that the smoothing capacitor has been discharged before maintenance.

When the capacitor has been discharged, the "CHARGE" lamp goes OFF.

15. MAINTENANCE.....	192	15.5.1 Controller	196
15.1 DAILY CHECK LIST.....	192	15.5.2 Gate Driver	197
15.2 PERIODICAL MAINTENANCE ...	193	15.6 PARTS REPLACEMENT	198
15.3 PERIODICAL CHECK LIST AND		15.6.1 Replacing the Controller	198
ACTION TO BE TAKEN	193	15.6.2 Replacing the Gate Driver.....	199
15.3.1 Insulation Resistance Test (Inverter).....	193	15.6.3 Replacing the Inverter Cooling Fan	200
15.3.2 Insulation Resistance Test (Motor)	193	15.6.4 Replacing the Motor Cooling Fan	200
15.3.2 Periodic Inspection	194	16. TROUBLESHOOTING	202
15.4 CHECKING MAIN CIRCUIT		17. SPARE PARTS	220
SEMICONDUCTORS	195		
15.5 PC BOARD	196		

上正科技有限公司
購買、維修 此手冊零組件

電話： 037-466333

Email: service@repairtw.com

Line id: @zzzz

www.repairtw.com

15. MAINTENANCE

Plan and perform maintenance and management to keep the VS- 626VM3 Drives in good condition.

-  - Warning of electric shock -

When an inspection is made on the VS-626VM3, do not touch the inside at least 5 minutes after the power supply is turned OFF. Verify that the smoothing capacitor electric discharge has been completed before starting maintenance.
At this time, the charge indicator lamp "CHARGE" is extinguished.

15.1 DAILY CHECK LIST

Check the items listed in the following table daily.

Table 15.1 Daily Check List

Classification	Check Procedure		Criteria	Remedy
	Check Item	Method		
Ambient	Ambient temperature	Thermometer	Inverter: 0°C to +55°C (Above freezing) Motor: 0°C to +40°C	Improve installation environment to meet the specification.
	Humidity	Hydrometer	95% RH or lower (Non-condensing)	
	Ventilation	Visual check	Entry and exhaust ports must not be obstructed.	Remove obstacles.
Power conditions	Voltage	Voltmeter	Must be from +10% to -15% of rated voltage.	Adjust voltage within the specified range (by a tap changer).
	Current	Ammeter	Must not be greater than the rating. Must be free from cyclic fluctuations.	Adjust load.
Appearance	Dust and stains (with dust, etc.) on the inverter Dust and stains on the motor shaft opening	Visual check	Must not be present	Clean if dirty.
Operation status	Vibration	Touch or use a vibrometer.	Must be free from unusual vibration or increase in magnitude.	If allowable limit is exceeded, stop operation and correct the cause.
	Odor	Smell.	Must be free from burning odor.	Stop operation and correct the cause.
	Abnormal sound	Listen.	Must be free from unusual sound or increase of noise.	If operation is hindered, stop operation and correct the cause.
	Rise of inverter or motor temperature	Touch with care or use a thermometer.	Must be free from excessive temperature rise over usual operating temperature.	Stop operation and cool the system. Check for abnormality in the cooling system (e.g. the fan). Repair if damaged.
Around the bearing	Bearing noise	Listen or use a stethoscopic rod.	Must be free from unusual sound or increase of noise.	Replace the bearing.
	Vibration	Touch or use a vibrometer.	Must be free from excessive vibration.	
	Bearing temperature	Touch with care or use a thermometer.	Must be free from excessive temperature rise over usual operating temperature.	
	Grease	Visual check	Must not be leaking.	Correct the cause and restore the normal condition.
Motor cooling Fan	Operation state	Visual or aural check	Normal operation	Correct the cause of fan stoppage or replace the motor if damaged.

15.2 PERIODICAL MAINTENANCE

Observe the following procedures and clean the inverter and the motor periodically.

- (1) If an air filter is used in the control panel, clean the filter once a month.
- (2) Dust on electronic components can lead to overheating and insulation deterioration. Remove dust periodically. Dust or oil on the heat sink placed on the back of the controller may impair heat dissipation and result in a failure. Clean the heat sink once every six months by blowing compressed air or with a dry cloth. (Clean more frequently if necessary.)
- (3) Daily check that vibration and noise are not greater than normal level by touch and hearing.
- (4) Clean the exterior with a dry cloth or compressed air as required.

15.3 PERIODICAL CHECK LIST AND ACTION TO BE TAKEN

15.3.1 Insulation Resistance Test (Inverter)

Perform insulation resistance test for the main circuit using an insulation resistance meter (500V) as explained below.

- (1) Remove wiring from the pins of the inverter main and control circuits. Check insulation resistance between the main circuit pins and the ground (Grounding pin G(E)).
- (2) Normal indication is $1M\Omega$ or greater.

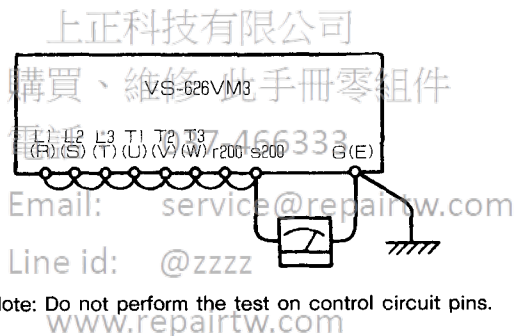

Note: Do not perform the test on control circuit pins.

Fig.15.1 Insulation Resistance Test (Inverter)

15.3.2 Insulation Resistance Test (Motor)

Perform insulation resistance test using an insulation resistance meter (500VDC) as explained below.

- (1) Disconnect the motor from the inverter.
- (2) Measure the insulation resistance between any of the phase U, V or W of the motor power cables and the frame ground (FG). For spindle motors having six power cables U(U1), V(V1), W(W1), X(U2), Y(V2) and Z(W2), measure between each of U(U1), V(V1) and W(W1) and FG.
- (3) Make sure the resistance is more than $10M\Omega$.

15.3.2 Periodic Inspection

Refer to Table 15.2 to plan a maintenance schedule for periodic inspection.

Table 15.2 Periodic Inspection

Classification	Check Procedure		Criteria	Remedy
	Check Item	Method		
Daily Inspection Conditions	Inspection record	Visual	—	Use the information in periodic inspection.
Installation Conditions	Tightening bolts of the inverter and the motor	Visual	Must not be loose.	Tighten the bolts.
Grounding	Grounding pins of the inverter and the motor	Visual	Must be grounded securely.	Restore the initial condition and tighten.
Coating	Peeling and Corrosion	Visual	Must be free from damage, discoloration, peeling, and corrosion.	Apply anti-corrosion coating.
Cables and Connections	Loose connection, break in wire cover, terminal box	Visual	Must be free from loose connection or break. Must be free from deterioration or deformation.	Restore the initial condition and tighten.
Cooling Fan	Vibration	Touch.	Must be free from unusual vibration or increase in magnitude.	Replace the cooling fan.
	Abnormal sound	Check by hearing.	Must be free from unusual sound or increase of noise.	
Electrolytic Capacitor	Leak and expansion	Visual Check	Must be free from abnormalities such as leak of liquid or expansion.	Replace the parts.
	(Capacitance measurement)	(Capacitance measurement instrument)	(Must be within the specifications.)	
Relays and Contactors	Abnormal sound when functioning	Listen	Must be free from chattering noise.	Replace the parts.
Resistors	Cracks in insulating material	Visual check	Must be free from abnormalities.	Replace the parts.
	Break in wire	Circuit tester and the like	Must be within the specifications.	
PC Board	Discoloration	Visual	Must be free from abnormal or partial discoloration.	Replace the PC board.
Control Circuit	Operation check	Inverter stand-alone operation	Output voltage phases must be balanced well.	Adjust the PC board or repair the inverter.
Insulation Resistance	Inverter (Between the main circuit and ground)	See Para.15.3.1.	Must be above the specifications.	Repair.
	Motor (Between the stator and ground)	See Para.15.3.2.	500VDC 10MΩ or more	If the resistance is less than 10MΩ, contact your YASKAWA representative.
Motor Connection Conditions	Run-out	See Para.11.1.3.	See Para.11.1.3.	Readjust direct coupling and positioning.
1. Shaft Coupling 2. V-belt	Sunk keys	Visual	Must be free from damage and deformation.	Replace parts.
	Shaft coupling without key		Alignment marks must match.	Restore initial conditions.
	Tightening reamer bolt		Must not be loose.	Tighten the bolt.
	Abrasion		Abrasion must be slight.	Replace the parts.
Motor	Bearing	Listen or use a vibrometer. (Period:12000 hours or two years)	Must be free from unusual sound, vibration increase or temperature rise.	Disassemble and replace the worn parts.
	Cooling fan	Listen or use a vibrometer. (Period:15000 hours or two years)		Replace the cooling fan unit. (See Para.15.6.4.)
	Oil Seal	Visual (Period: 5000 hours)	Abrasion must be slight.	Disconnect the motor from load machines and replace the seal.
	Overall	Contact your YASKAWA representative. (Period:20000 hours or 5 years)	—	Do not perform breakdown or cleaning by yourself.

-  - Precaution if the drives are unused for a long time

If the inverter unit is installed as a stand-by machine and is not always used, turn ON power once each six months and check operation.

Especially if the electrolytic capacitor is unused for a long time (a year or longer), it needs re-forming. Re-form the capacitor by the following procedures:

- (1) Turn OFF emergency stop signal and turn to power. ("CHARGE" lights out.)
- (2) Turn ON emergency stop signal. ("CHARGE" lights brightly.)
- (3) Continue energizing for 30 minutes before running the motor.

Manually rotate the motor shaft slightly to distribute the oil in the bearings.

15.4 CHECKING MAIN CIRCUIT SEMICONDUCTORS

Before checking semiconductors in the main circuit, remove the gate driver. (See Par. 15.6, "Parts Replacement.")

To install the gate driver, properly connect connector lead wires to specified connector pins and connection screws.

Securely tighten connection screws.

- ★ - A single loose screw may disable the drive.

[Check procedure for IGBT module terminals]

Measure resistance between the terminals listed in Table 15.3 with a circuit tester.

Table 15.3 Resistances in IGBT Module

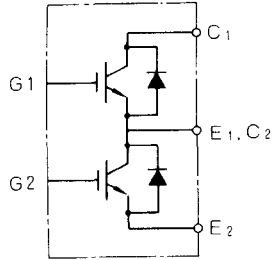
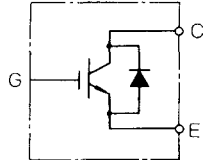
Inverter Type CIMR-VM 	Tester Terminal	Tester Terminal	Reference Value	Abnormal Value	Transistor Module Terminals
7.5 k 11 k 15 k 18.5 k	C ₁	E ₁ , C ₂	∞	0 Ω	 <p>Check terminals in the IGBT module.</p>
	E ₁ , C ₂	E ₂	∞	0 Ω	
	E ₁ , C ₂	C ₁	Several ohms to several tens of ohms	0 Ω or ∞	
	E ₂	E ₁ , C ₂			
	G ₁	E ₁ , C ₂	∞	0 Ω ~ Several Ω	
	G ₂	E ₂			
22 k 30 k	C	E	∞	0 Ω	 <p>Check terminals in the IGBT module.</p>
	E	C	Several ohms to several tens of ohms	0 Ω or Several ∞	
	G	E	∞	0 Ω ~ Several Ω	
	E	G	∞	0 Ω ~ Several Ω	

15.5.2 Gate Driver

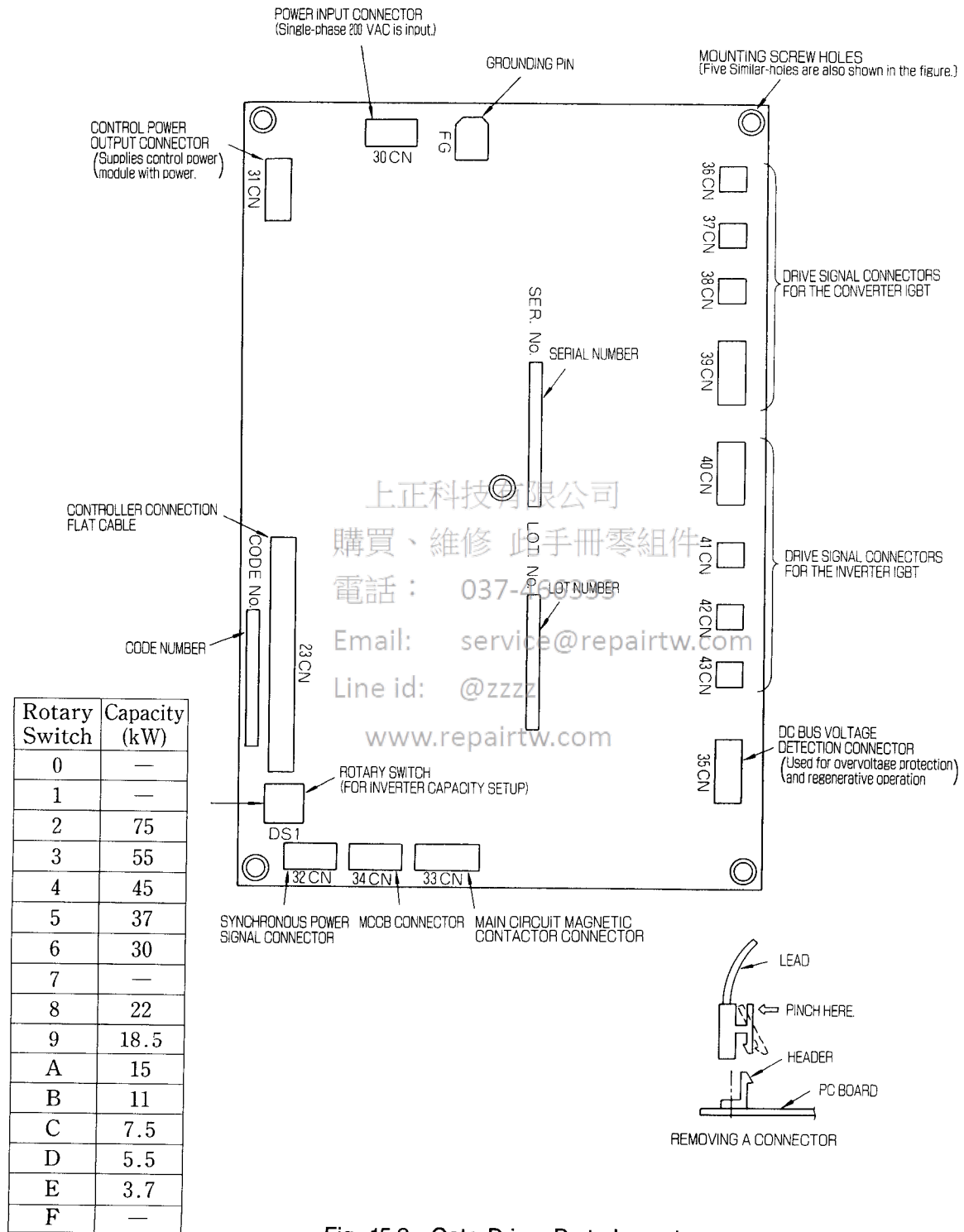

Fig. 15.3 Gate Driver Parts Layout

15.6 PARTS REPLACEMENT

If the PC board or the main circuit terminal of the VS- 626VM3 controller need to be replaced because of a failure, refer to the spare parts list and notify your YASKAWA representative with the type and code number of necessary parts.

- ⚡ - Precautions on replacing the PC board

Never replace the PC board nor remove/connect connectors when power is ON.
(Otherwise, circuit components may be damaged.)

15.6.1 Replacing the Controller

(1) How to remove the PC board (Fig. 15.4)

- Turn OFF power. Remove the connectors (1CN-3CN and 21CN- 27CN) and grounding wire from the controller.
- Loosen and remove the mounting screws (at two positions) from the digital operator and remove the operator.
- Loosen and remove the PC board mounting screws (five M4 screws) that fasten the controller. Hold the head of the PC board support with pliers and remove the controller from the support. (See Fig. 15.5.)

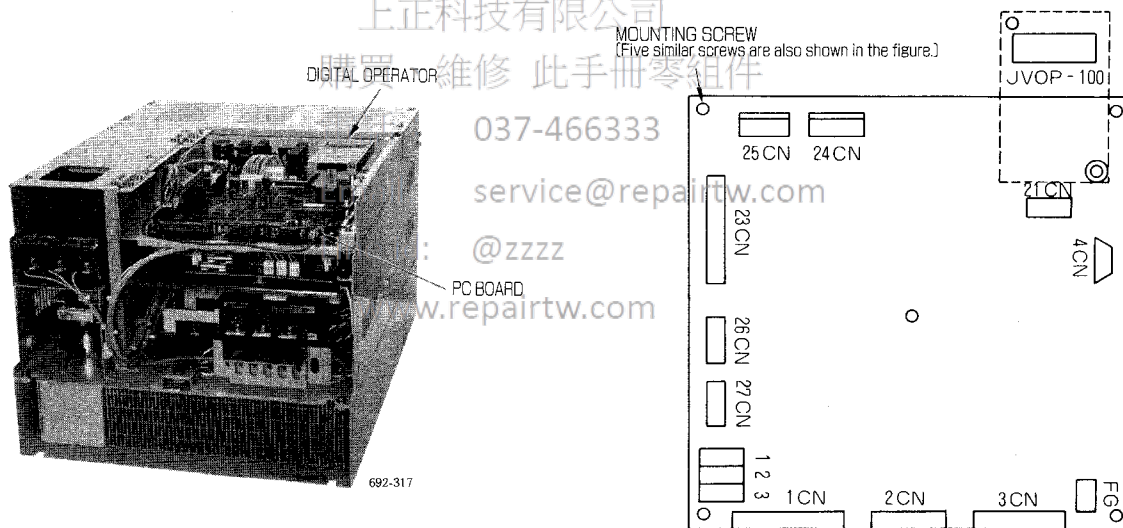

Fig. 15.4 Removing the Controller

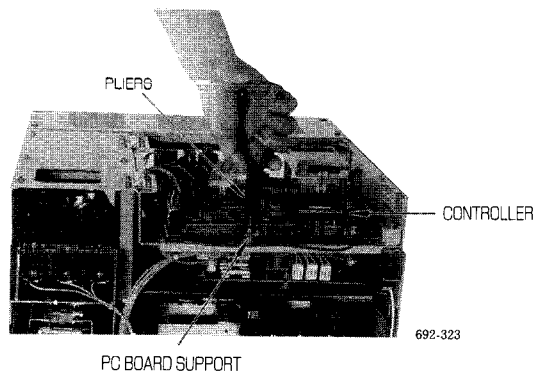
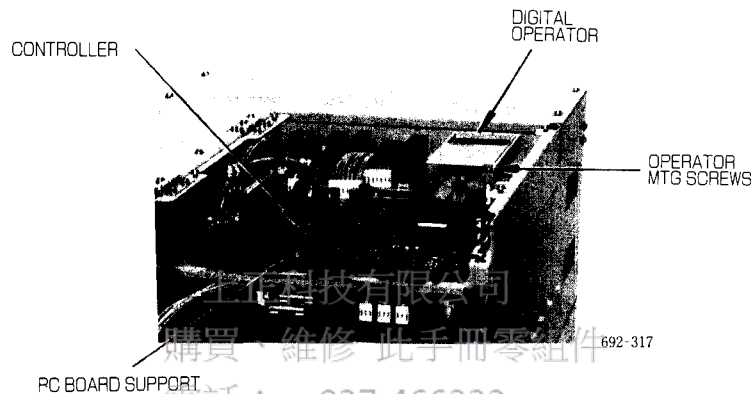

Fig. 15.5 Holding the PC Board Support with Pliers

(2) How to mount printed board

- Insert the controller guide hole into the printed board support.
At this time, the controller must be inserted into the printed board support groove properly.
- Tighten five printed board mounting screws to mount the controller.
- Tighten two digital operator mounting screws to mount the operator.
- Connect cables to connectors.
- Verify each setting of the controller before starting operation.



電話： 037-466333

Email: service@repairtw.com

Lin fidi@repairtw.com

Fig. 15.6 Installing Controller

www.repairtw.com

15.6.2 Replacing the Gate Driver

The gate driver is mounted on the rear surface of the controller.

(1) How to remove the PC board

- Turn OFF power. Open the PC board frame toward you and remove connectors 30CN to 43CN and 23CN, which connects to the controller, and the grounding wire from the gate driver.
- Loosen and remove the gate driver mounting screws (five M4 screws) that fasten the gate driver. Hold the head of the PC board support with pliers and remove the gate driver from the support.

(2) How to install the PC board

Install the PC board according to the procedure of controller mounting.

15.6.3 Replacing the Inverter Cooling Fan

The inverter houses a fan for cooling the heat sink. Replace the fan after a total operation time of about 20,000 hours. (See Fig. 15.7.)

- ⚠ - **Precaution on replacing the cooling fan**

Never replace the cooling fan nor remove/connect cables when power is ON.
(Otherwise, injury by electric shock or the rotating fan may occur.)

- (1) Turn OFF the power. After turning OFF the power, wait until the main circuit capacitor is discharged and "CHARGE" lamp goes OFF.
- (2) Remove screw "a" from the cooling fan relay terminal. Remove the lead wire.
- (3) Remove screw "b" that fastens the fan case on the side panel. Gently lift the fan case and remove the side panel.
- (4) Remove screws "c" (at two positions). Remove the cooling fan from the fan support.
- (5) To install the cooling fan, reverse steps (1) to (3). Make sure to mount the fan in proper orientation. Place the fan with the arrow (at word "AIR") pointing upward.

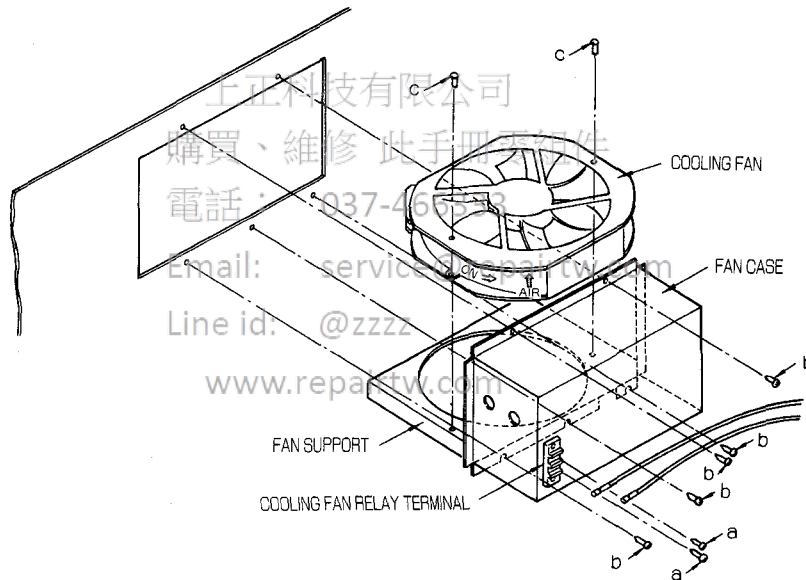

Fig. 15.7 Replacing the Inverter Cooling Fan

15.6.4 Replacing the Motor Cooling Fan

AC spindle motor is cooled by a fan mounted on the rear side of the motor. If the fan does not operate normally, replace the fan immediately. (See Fig. 15.8.) For spare parts, refer to Tables 17.3 and 17.4.

- ⚠ - **Precaution on replacing the cooling fan**

Never replace the cooling fan nor remove/connect cables while power is ON.
Never drop screws or small parts into motor recesses or cavities while working.

- (1) Turn OFF the power. After turning OFF the power, wait until the main circuit capacitor is discharged and “CHARGE” lamp goes OFF.
 - (2) Remove the lead wire of the cooling fan in the terminal box and draw the lead wire through the lead-in hole of the terminal box.
 - (3) Remove four housing mounting bolts and bolts attaching the terminal box to the housing.
 - (4) Remove the fan without detaching the housing.
 - (5) Mount a new cooling fan and housing. For installation, reverse steps (1) to (4).
 - (6) Apply Three Bond No. 1212 sealing material on the cable lead-in hole of the terminal box.
- Note: In procedure (4), if housing and terminal box interfere with each other and it is difficult to remove the housing, loosen the terminal box mounting bolts.

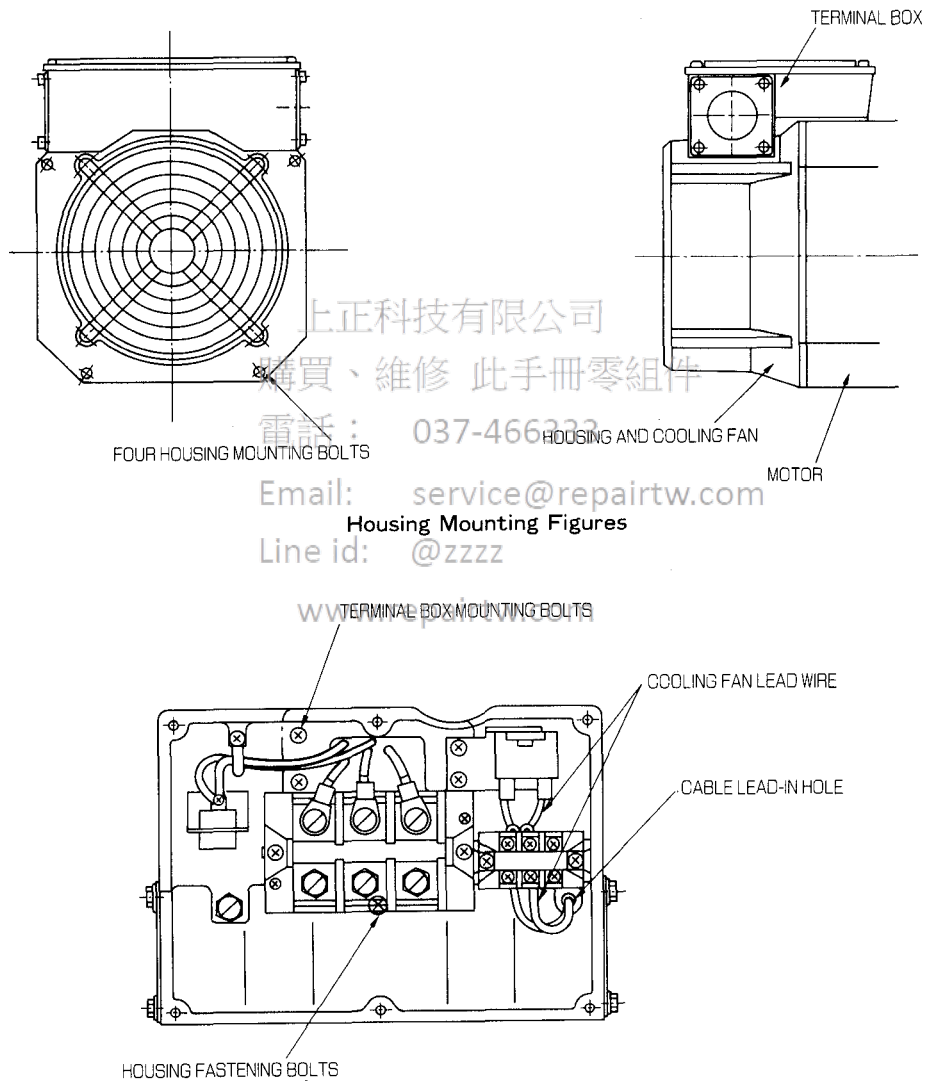

Terminal Box Configuration

Fig. 15.8 Replacing the Motor Cooling Fan

16. TROUBLESHOOTING

-  - Precaution on troubleshooting

VS-626VM3 employs various protective functions to secure itself from possible damage from external or internal causes; nevertheless, accidental failure of electric or electronic components or natural external elements such as lightening may cause unpredictable faults.

Troubleshooting explained in the following does not cover every possible defect caused by abnormal external influences. If a failure occurs and the cause cannot be determined by routine troubleshooting, immediately contact your YASKAWA representative. Further investigation may cause secondary damage.

If a trouble or an abnormal phenomena occurs in VS-626VM3 Drives, protective functions are activated and operation is stopped in some cases. In other cases, protective functions remain inactive and abnormal status is continued. Tables 16.1 and 16.2 list possible failure causes, checking procedures, and actions to be taken in the two situations. Observe the tables and take necessary action. If the remedy cannot recover normal status or parts need to be replaced, contact your YASKAWA representative and send the following data. (A list of YASKAWA service centers is on the back cover.)

- (1) Abnormal symptoms or activated protective functions
- (2) Status at the time of failure (at power ON, at the start of operation, when operation is halted, during acceleration, during deceleration, etc.)
- (3) Ambient conditions such as temperature and vibration
- (4) Type and serial number of both inverter and motor

Tables 16.1 and 16.2 are organized as follows:

www.repairtw.com

Table 16.1 Failure Cause and Action to be Taken

Activated Protective Function	Situation of Failure						Possible cause of the failure	Troubleshooting		Remedy	
	At Power-ON	Operation Started	Operation Halted	During Acceleration	During Deceleration	With load		Failure Cause	Checking Procedure		Result
									Checking Procedure		Result
Winding Selection Failed (F000)	○						Motor code selection error	Check control constant C1-25 on the parameter list.	Disagreed with the control constant in the parameter list.	Correct the control constant.	
								Agreed.	←		
	○	○	○	○	○		NO Drive power is supplied to the winding selection magnetic contactor.	Check whether specified voltage is applied between pins 17 and 18 of the contactor.	Voltage is not applied.	Correct wiring of the drive power cables.	
							Connection error or disconnection in the signal wires of the winding selection magnetic contactor.	Check wiring on the connection diagram.	Voltage is normal.		←
								Erroneous wiring	←	Correct wiring of the signal wires of the winding selection magnetic contactor.	
								Proper wiring	←		

Indication of activated protective function

Possible cause of the failure

If "Contact your YASKAWA representative" is shown in this column, contact him immediately.

Situations where the failure may occur are marked with ○. Use the data to narrow down possible causes.

Take action described in the right column. Proceed to the next step.

購買、維修 此手冊零組件
 電話： 037-466333
 Email: service@repairtw.com
 Line id: @zzzz
 www.repairtw.com

Table 16.1 Failure Cause and Action to be Taken (Cont'd)

Activated Protective Function	Situation of Failure						Failure Cause	Troubleshooting		Remedy
	At Power-ON	Operation Started	Operation Halted	During Acceleration	During Deceleration	With load		Checking Procedure	Result	
Winding Selection Failed (F000)	<input type="radio"/>						Motor code selection error	Check control constant C1-25 on the parameter list.	Disagreed with control constant in the list. Agreed: <input type="checkbox"/>	Correct the control constant.
							NO Drive power is supplied to the winding selection magnetic contactor.	Check whether specified voltage is applied between pins 17 and 18 of the contactor.	Voltage is not applied. Voltage is normal: <input type="checkbox"/>	Correct wiring of the drive power cables.
	<input type="radio"/>	<input type="radio"/>	<input type="radio"/>	<input type="radio"/>	<input type="radio"/>	<input type="radio"/>	Connection error or disconnection in the signal wires of the winding selection magnetic contactor.	Check wiring on the connection diagram.	Erroneous wiring Proper wiring: <input type="checkbox"/>	Correct wiring of the signal wire of the winding selection magnetic contactor.
							Failure of the winding selection magnetic contactor (wire break in the coil or loose contact)	Windings Selection to check the operation.	Malfunctioned. Normally functioned: <input type="checkbox"/>	Replace the winding selection magnetic contactor.
							Failure of the controller	Check if the failure can be reproduced.	Reproduced. Not reproduced.	Replace the controller. Continue operation with care.
Emergency Stop Failed (F001)					<input type="radio"/>		Braking torque was reduced by torque limiting.	Check control constant C1-24. Also check whether TLL or TLH was commanded.	TLL or TLH was commanded when emergency stop occurred. Torque was not limited: <input type="checkbox"/>	Modify the operation circuit to prevent TLL and TLH being activated at emergency stop.
						<input type="radio"/>	Motor code selection error	Check control constant C1-25 on the parameter list.	Disagreed with control constant in the list. Agreed: <input type="checkbox"/>	Correct the control constant.
							Excess load inertial momentum	Check if accel/dec time to reach the rated speed is 10 seconds or longer. (Set 0.1 second for C1-10.)	10 seconds or longer Less than 10 seconds: <input type="checkbox"/>	• Reduce inertial momentum. • Increase inverter capacity.
Inverter Output Over-current (F100)		<input type="radio"/>					Erroneous wiring in the main circuit	Check wiring on the connection diagram.	Erroneous wiring Proper wiring: <input type="checkbox"/>	Correct wiring of the main circuit.
		<input type="radio"/>		<input type="radio"/>	<input type="radio"/>		Layer short circuit in the motor winding	Check resistance between motor terminals. [A circuit tester is necessary.]	Short-circuited Normal: <input type="checkbox"/>	Replace the motor. [Contact your YASKAWA representative.]
							Ground fault	Check of an input or output pin of the inverter is short-circuited with the ground.	Ground fault Normal: <input type="checkbox"/>	Repair short-circuited portion.

Table 16.1 Failure Cause and Action to be Taken (Cont'd)

Activated Protective Function	Situation of Failure						Failure Cause	Troubleshooting		Remedy
	At Power-ON	Operation Started	Operation Halted	During Acceleration	During Deceleration	With load		Checking Procedure	Result	
Inverter Output Over-current (F100)							Motor encoder failure	Check for abnormal changes of motor speed on the speed meter or operation status display (V1-01)	Speed is abnormal. Normal <input type="checkbox"/>	Replace the encoder or the motor. [Contact your YASKAWA representative]
		○		○	○	○	Motor code selection error	Check control constant C1-25 on the parameter list.	Disagreed with control constant in the list. Agreed. <input type="checkbox"/>	Correct the control constant.
							Control constant setting error	Check the control constants on the parameter list.	Disagreed with control constants in the list. Agreed. <input type="checkbox"/>	Correct the control constants.
							Connection error or disconnection in the current detection signal wire..	Check if connector 26CN or 27CN is loose.	Loose Normal <input type="checkbox"/>	Insert the pins and connectors securely.
		○	○	○	○	○	Damage of the IGBT module	Check resistance of the IGBT module according to Table 15.3.	Abnormal Within specifications <input type="checkbox"/>	Replace the IGBT module. [Contact your YASKAWA representative]
							Controller failure	Check if the failure can be reproduced.	Reproduced. Not reproduced. <input type="checkbox"/>	Relace the controller. Continue operation with care.
							Failure of the main circuit magnetic contactor (MC) (Wire break in the coil or loose contact)	Check whether the MC is activated within several seconds after emergency stop is canceled.	Not activated. Activated. <input type="checkbox"/>	Repair the inverter. (Replace the MC.) [Contact your YASKAWA representative.]
		○	○	○	○	○	Controller failure	Check if the failure can be reproduced	Reproduced. Not reproduced. <input type="checkbox"/>	Replace the controller. Continue operation with care.
MCCB Tripped (F201)							The MCCB is OFF.	Check the position of the MCCB operation lever.	The lever is in the OFF position. The lever is ON. <input type="checkbox"/>	Shut down power, turn on the MCCB, then turn ON power again.
		○					Failure of the main circuit magnetic contactor (MC) (Contact welded)	Check whether the MCCB trips if power is turned ON while emergency stop (EMG) is disconnected.	Tripped. Not tripped. <input type="checkbox"/>	Repair the inverter. (Replace the MC.) [Contact your YASKAWA representative]
							Open phase in power line	Check voltage between input pins.	Phase is open. Normal <input type="checkbox"/>	Correct the power source.
		○	○	○	○	○	Damage of the IGBT module	Check resistance of the IGBT module according to Table 15.3.	Abnormal Within specifications <input type="checkbox"/>	Replace the IGBT module. [Contact your YASKAWA representative.]

Table 16.1 Failure Cause and Action to be Taken (Cont'd)

Activated Protective Function	Situation of Failure						Failure Cause	Troubleshooting		Remedy
	At Power-ON	Operation Started	Operation Halting	During Acceleration	During Deceleration	With load		Checking Procedure	Result	
MCCB Tripped (F201)	○	○	○	○	○	○	Controller failure	Check reproducibility of the failure.	Reproduced.	Replace the controller
									Not reproduced.	Continue operation with care.
Inverter Input Over-current (F300)	○						Erroneous wiring in the main circuit	Check up wiring on the connection diagram.	Erroneous wiring	Correct wiring of the signal wires of the main circuit.
									Proper wiring	
							Ground fault	Check of an input or output pin of the inverter is short-circuited with the ground.	Ground fault	Repair short circuit.
									Normal	
							Open phase in power current or power loss.	Check voltage between input pins.	Open phase or power loss occurred	Correct the power source.
									Normal	
							Motor code selection error	Check control constant C1-25 on the parameter list.	Disagreed with control constant in the list.	Correct the control constant.
									Agreed.	
							Control constant setting error	Check the control constants on the parameter list.	Disagreed with control constants in the list.	Correct the control constants.
									Agreed.	
Connection error or disconnection in the current detection signal wire.	Check if connector 26CN or 27CN is loose.	Loose	Insert the pins and connectors securely.							
		Normal								
Damage of the IGBT module	Check resistance of the IGBT module according to Table 15.3.	Abnormal	Replace the IGBT module. [Contact your YASKAWA representative.]							
		within specifications								
Deceleration from a speed in excess of the low-speed winding coverage	Check winding selection command and speed reference.	Deceleration started from a speed in excess of the low-speed winding coverage.	Modify the circuit to prevent selecting the low-speed winding if speed reference is above the low-speed winding coverage							
		Normal								
Controller failure	Check if the failure can be reproduced.	Reproduced.	Replace the controller.							
		Not reproduced.		Continue operation with care.						
Inverter Over-voltage (F400)				○		Power voltage is too high.	Check voltage between input pins.	Voltage is out of the specification range.	Adjust power voltage within specification range by a tap changer.	
								Normal		
								Open phase loss or power occurred.		Correct the power source.
Normal										

Table 16.1 Failure Cause and Action to be Taken (Cont'd)

Activated Protective Function	Situation of Failure						Failure Cause	Troubleshooting		Remedy
	At Power-ON	Operation Started	Operation Halting	During Acceleration	During Deceleration	With load		Checking Procedure	Result	
Inverter Over-voltage (F400)							Motor code selection error	Check control constant C1-25 on the parameter list	Disagreed with control constant in the list. Agreed. <input checked="" type="checkbox"/>	Correct the control constant.
						○	Control constant setting error	Check the control constants on the parameter list.	Disagreed with control constants in the list. Agreed. <input checked="" type="checkbox"/>	Correct the control constant.
							Failure of the main circuit magnetic contactor (MC) (Wire break in the coil or loose contact)	Check whether the MC is activated within several seconds after emergency stop is canceled.	Not activated. Activated. <input checked="" type="checkbox"/>	Repair the inverter. (Replace the MC.) [Contact your YASKAWA representative]
		○	○	○	○	○	Controller failure	Check if the failure, can be reproduced.	Reproduced. Not reproduced.	Replace the controller. Continue operation with care.
			○	○	○	○	Malfunctioning because of noise (Poor encoder cable characteristics)	Check encoder cable specifications (whether the cable is a twisted pair shielded wire)	Not a twisted pair shielded wire Normal <input checked="" type="checkbox"/>	Replace the encoder cable. [Recommended cable: KQVV-SW manufactured by Fujikura Cables]
						○	Motor encoder failure	Check for abnormal changes of motor speed on the speedometer or operation status display (V1-01).	Speed is abnormal. Normal <input checked="" type="checkbox"/>	Replace the encoder or the motor. [Contact your YASKAWA representative]
Motor Over-speed (F500)		○	○	○	○	○	Control constant setting error	Check up the control constants on the parameter list.	Disagreed with control constants in the list. Agreed. <input checked="" type="checkbox"/>	Correct the control constants.
							Controller failure	Check if the failure can be reproduced.	Reproduced. Not reproduced.	Replace the controller. Continue operation with care.
	○						Synchronous power source fuse has been blown.	Turn OFF power and check if fuse FU1 or FU2 on the power interface card has been blown.	Blown Normal <input checked="" type="checkbox"/>	Replace the power interface card. [Contact your YASKAWA representative]
	Power Frequency Error 1 (F601)							Wide distortion of power voltage	Check waveform of voltage between input pins. (Must be free from large gaps. [An oscilloscope is necessary.])	There is a gap in voltage waveform. No gap. <input checked="" type="checkbox"/>
							Controller failure	Check if the failure can be reproduced.	Reproduced.	Replace the controller.
									Not reproduced.	Continue operation with care.

Table 16.1 Failure Cause and Action to be Taken (Cont'd)

Activated Protective Function	Situation of Failure						Failure Cause	Troubleshooting		Remedy	
	At Power-ON	Operation Started	Operation Halting	During Acceleration	During Deceleration	With load		Checking Procedure	Result		
									Result		
Power Voltage Error 2 (F602)							Wide distortion of power voltage 	Check waveform of voltage between input pins. (Must be free from large gaps) [An oscilloscope is necessary.]	There is a gap in voltage wave form.	Modify power supply system. Correct the cause of power distortion.	
							Open phase in power current or power loss		No gap. <input checked="" type="checkbox"/>		
	Power Frequency Error 2 (F603)	○	○	○	○	○	○	Power voltage is low (because regenerative performance is deteriorated by voltage drop).	Check voltage between input pins.	Phase is missing or power loss occurred.	Correct the power source.
									Normal <input checked="" type="checkbox"/>		
	Power Voltage Error 3 (F604)							Loose contact in fuse for braking power source.	Turn OFF power and check if fuse FU3 or FU4 on the power interface card is loose in the holder.	Loose.	Correct the fuse holder and securely fasten the fuse.
							Controller failure	Check if the failure can be reproduced.	Reproduced. <input checked="" type="checkbox"/>		
									Not reproduced. <input type="checkbox"/>	Replace the controller. Continue operation with care.	
Inverter Output Overload (F700)						○	Motor overload	Check load status on the load factor meter.	Overloaded <input checked="" type="checkbox"/>	Reduce load.	
							Frequent accel/decel	Check frequency of accel/decel from operation pattern. (See Par. 7.2.4.)	Frequent <input checked="" type="checkbox"/>		Reduce frequency of accel/decel.
							Erroneous wiring or connection in the main circuit	Check wiring between the inverter and the motor.	Erroneous wiring <input checked="" type="checkbox"/>	Correct wiring of the main circuit.	
							Motor encoder failure	Check for abnormal changes of motor speed on the speedometer or operation status display (V1-01).	Speed is abnormal. <input checked="" type="checkbox"/>		Replace the encoder or the motor. [Contact your YASKAWA representative]
							Disconnection, erroneous connection, or loose connector in the encoder signal wires	Check wiring of the encoder signal wires.	Proper wiring <input checked="" type="checkbox"/>	Correct wiring of the encoder signal wires.	
	Input Overload (F701)	○			○			Motor code selection error	Check control constant C1-25 on the parameter list.		Disagreed with control constant in the list. <input checked="" type="checkbox"/>
									Agreed. <input type="checkbox"/>		
								Control constant setting error	Check the control constants on the parameter list.	Disagreed with control constant in the list. <input checked="" type="checkbox"/>	Correct the control constants.
								Agreed. <input type="checkbox"/>			

Table 16.1 Failure Cause and Action to be Taken (Cont'd)

Activated Protective Function	Situation of Failure						Failure Cause	Troubleshooting		Remedy
	At Power-ON	Operation Started	Operation Halted	During Acceleration	During Deceleration	With load		Checking Procedure	Result	
Inverter Output Overload (F700) Inverter Input Overload (F701)	○	○	○	○	○	○	Controller failure	Check if the failure can be reproduced.	Reproduced.	Replace the controller.
									Not reproduced.	Continue operation with care.
Excess Speed Deviation (F800)						○	Motor overload	Check if load is excessive or a blade is caught.	Overloaded	Reduce load.
									Normal	
						○	Torque limiting operation	Check if external torque limiting signal ([TLL] or [TLH]) was input	Torque was limited.	Cancel torque limiting.
									Torque was not limited.	
				○		○	Control constant setting error	Check the control constants on the parameter list.	Disagreed with control constants in the list.	Correct the control constants.
									Agreed.	
		○		○	○	○	Erroneous wiring or connection in the main circuit	Check wiring between the inverter and the motor.	Erroneous wiring	Correct wiring of the main circuit.
									Proper wiring	
							Disconnection, erroneous connection, or loose connector in the encoder signal wires	Check wiring of the encoder signal wires.	Erroneous wiring	Correct wiring of the encoder signal wires.
									Proper wiring	
		○		○		Malfunctioning because of noise (Poor encoder signal wire characteristics)	Check encoder signal wire specifications (Whether the signal wire is a twisted pair shielded wire)	Not a twisted pair shielded wire	Replace the encoder signal wire. [Recommended cable: KQVV-SW manufactured by Fujikura Cables]	
								Normal		←
	○	○	○	○	○	Motor encoder failure	Check for abnormal changes of motor speed on the speedometer or operation status display (V1-01).	Speed is abnormal.	Replace the encoder or the motor. [Contact your YASKAWA representative]	
								Normal		←
						Controller failure	Check if the failure can be reproduced.	Reproduced.	Replace the controller.	
								Not reproduced.	Continue operation with care.	
Motor Thermal Error 1 (F900)							Motor overload	Check motor temperature on the operation status display (V7-01)	Motor Temperature is near the upper limit.	Stop operation and cool the motor.
								Motor temperature is low.	←	
				○	○	○	Disconnection in the motor cooling fan power cable	Check wiring on the connection diagram.	Erroneous wiring	Correct wiring of the motor cooling fan power cable.
								Proper wiring	←	
Motor Thermal Error 2 (F901)							Motor cooling fan failure	Turn ON power and check if motor cooling air flow is normal. (See Fig. 14.1)	Cooling air does not flow.	Replace the motor cooling fan or the motor. [Contact your YASKAWA representative]
									Normal	

Table 16.1 Failure Cause and Action to be Taken (Cont'd)

Activated Protective Function	Situation of Failure						Failure Cause	Troubleshooting		Remedy
	At Power-ON	Operation Started	Operation Halted	During Acceleration	During Deceleration	With load		Checking Procedure	Result	
Motor Thermal Error 1 (F900)				○	○	○	Deteriorated motor cooling performance	Check for dust and oil in the passage of motor cooling air.	Excessive dust/oil	Clean the motor. [Disassembling and cleaning may be required depending on extent of contamination. Contact your YASKAWA representative]
									Normal	
Motor Thermal Error 2 (F901)	○	○	○	○	○	○	Short circuit in the thermistor signal wire	Check wiring of the motor thermistor signal wires.	Erroneous wiring	Correct wiring of the motor thermistor signal wires.
							Controller failure	Check if the failure can be reproduced.	Proper wiring	
Motor Thermal Error 3 (F902)							Motor temperature is low.	Check motor ambient temperature.	Reproduced.	Warm the ambient air to -10°C or higher. [Monitor the motor temperature on operation status display (V7-1).]
	○		○						-10°C or lower	
							Thermistor signal wire disconnection	Check motor temperature on the operation status display (V7-01)	Not reproduced.	Correct wiring of the motor thermistor signal wires.
	○	○	○	○	○	○			-10°C or higher	
							Controller failure	Check if the failure can be reproduced.	Reproduced.	Replace the controller.
									Not reproduced.	Continue operation with care.
Heat Sink Thermal Error 1 (F903)							Inverter overload	Check the heat sink temperature on operation status display (V1-13, heat sink temperature).	Heat sink temperature is near the upper limit.	Stop operation and cool the inverter.
									Heat sink temperature is low.	
	Heat Sink Thermal Error 2 (F904)				○	○	○	Inverter cooling fan failure	Turn ON power and check if inverter cooling air flow is normal, (See Fig. 11.3.)	Cooling air does not flow.
									Normal	←
Heat Sink Thermal Error 2 (F904)							Deteriorated heat sink cooling performance	Check for dust and oil on the heat sink.	Excessive dust/oil.	Clean the heat sink of the inverter. [Disassembling and cleaning may be required depending on the extent of contamination. Contact your YASKAWA representative]
									Normal	
	○	○	○	○	○	○	Short circuit in the thermistor signal wire	Check wiring of the heat sink thermistor signal wires.	Erroneous wiring	Correct wiring of the heat sink thermistor signal wires.
							Controller failure	Check if the failure can be reproduced.	Proper wiring	
									Reproduced.	Replace the controller.
									Not reproduced.	Continue operation with care.

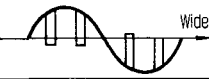
Table 16.1 Failure Cause and Action to be Taken (Cont'd)

Activated Protective Function	Situation of Failure						Failure Cause	Troubleshooting		Remedy						
	At Power-ON	Operation Started	Operation Halted	During Acceleration	During Deceleration	With load		Checking Procedure	Result							
Heat Sink Thermal Error 3 (F905)	○	○	○	○	○	○	Inverter ambient temperature is low.	Check inverter ambient temperature.	-10°C or lower	Warm the ambient air to -10°C or higher. [Monitor the heat sink temperature on operation status display (V1-13).]						
									-10°C or higher		←					
	○	○	○	○	○	○	Short circuit in the thermistor signal wire for heat sink temperature detection	Check the inverter temperature on operation status display (V1-13).	-10°C or lower	Correct wiring of the thermistor signal wires for heat sink temperature detection.						
									-10°C or higher		←					
○	○	○	○	○	○	Controller failure	Check if the failure can be reproduced.	Reproduced.	Replace the controller.							
								Not reproduced.	Continue operation with care.							
Control Panel Thermal Error 1 (F906)	○	○	○	○	○	○	Inverter ambient temperature is high.	Check inverter ambient temperature.	+55°C or higher	Stop operation and cool the inverter. [Monitor the heat sink temperature on operation status display (V1-12).]						
Control Panel Thermal Error 2 (F907)	○	○	○	○	○	○	Controller failure	Check if the failure can be reproduced.	+55°C or lower		←					
Initial Charging Incomplete (FA00)	○	○	○	○	○	○	Failure of the main circuit magnetic contactor (MC)	Check whether the MC is activated within several seconds after emergency stop is canceled.	Not activated.	Repair the inverter. (Replace the MC.) [Contact your YASKAWA representative.]						
									Activated.		←					
							○	○	○	○	○	○	Failure of the charge current suppression resistor	Check whether the main circuit capacitor is charged on operation status display (V1-14)	Capacitor voltage is not greater than 1.2 times of the input voltage (rms).	Repair the inverter. (Replace the charge current suppression resistor.) [Contact your YASKAWA representative]
															Voltage is normal.	
○	○	○	○	○	○	Controller failure	Check if the failure can be reproduced.	Reproduced.	Replace the controller.							
								Not reproduced.	Continue operation with care.							
Controller Failure 1 to 9 (Fb00 to 03 Fd00 FE00 to 03)	○	○	○	○	○	○	Controller failure or connection error	Check if the failure can be reproduced.	Reproduced.	• Check the wiring of connectors or reference voltage (+15V) signal (1CN-1). • Replace the controller.						
CPU failure 1 to 2 (CPF00 CPF01)	○	○	○	○	○	○			Not reproduced.	Continue operation with care.						
I/O Error 1 to 2 (FF00 to 03)	○	○	○	○	○	○										

Table 16.1 Failure Cause and Action to be Taken (Cont'd)

Activated Protective Function	Situation of Failure						Failure Cause	Troubleshooting		Remedy
	At Power-ON	Operation Started	Operation Halted	During Acceleration	During Deceleration	With load		Checking Procedure	Result	
Disconnection in Speed Detection Signal Wire (FC00)	○	○	○	○	○	○	Disconnection, erroneous connection, or loose connector in the encoder signal wires	Check wiring of the encoder signal wires.	Erroneous wiring Proper wiring ←	Correct wiring of the encoder signal wires.
							Controller failure	Check if the failure can be reproduced.	Reproduced. Not reproduced.	Replace the controller. Continue operation with care.
Soft Version Unmatch (Fd01)	○						Controller and PROM versions unmatch.	Compare controller code number and PROM number to check applicable version.	Mismatched. Normal ←	Replace with proper applicable PROM. [Contact your YASKAWA representative]
							Controller failure	Check if the failure can be reproduced.	Reproduced. Not reproduced.	Replace the controller. Continue operation with care.
Position Detector Failure 1 (Fd11)							Disconnection in the load axis encoder phase-C signal wire	Check wiring of the load axis encoder signal wire.	Erroneous wiring Proper wiring ←	Correct wiring of the load axis encoder signal wires.
							Load axis encoder failure	Turn the load axis by hand and monitor operation status display (V1-10) to check whether [ORG] signal lights once per rotation.	Remains OFF.	Replace the load axis encoder.
							Orientation card failure	Check phase-A, -B, and -C pulses at the check pins on the orientation card. [An oscilloscope is necessary.]	Lights. Phase -A, -B, and -C phases are normal. Pulses are missing.	Tune up again. Replace the orientation card. Replace the load axis encoder.
Position Detector Failure 2 (Fd12)	○						Load axis encoder failure	Check phase-A, -B, and -C pulses at the check pins on the orientation card. [An oscilloscope is necessary.]	Pulses are missing or pulse width is abnormal. Pulses are normal. ←	Replace the load axis encoder.
							Controller failure	Check if the failure can be reproduced.	Reproduced. Not reproduced.	Replace the controller. Continue operation with care.
Position Detector Failure 3 (Fd13)										
Tune-up Incomplete (Fd14)		○					Tune-up for orientation was incompleated.	-	-	Adjust according to Par. 14.4, Adjustment Procedure and Control Constant Adjustment.

Table 16.1 Failure Cause and Action to be Taken (Cont'd)

Activated Protective Function	Situation of Failure						Failure Cause	Troubleshooting		Remedy
	At Power-ON	Operation Started	Operation Halted	During Acceleration	During Deceleration	With load		Checking Procedure	Result	
INC Error (Fd15)	○						Power was turned ON when INC was ON.	Run again using the same operation parameters to reproduce the failure .	INC error occurred again,	Modify the circuit so that INC is commanded after absolute positioning is performed.
				○	○	○	INC was turned ON while the motor was rotating.		Normal	
		○							INC was turned ON before absolute positioning is performed.	
Disconnection in Magnetic Sensor Signal Wire (Fd17)							Disconnection in the magnetic sensor signal wire	Check wiring of the magnetic sensor signal wire.	Erroneous wiring	Correct wiring of the magnetic sensor signal wire.
								Proper wiring	←	
							Magnetic sensor failure	Turn the load axis by hand and monitor operation status display (V1-10) to check whether ORG signal lights once per rotation.	Remains OFF.	Replace the magnetic sensor.
Motor Code Selection Error (FE04)	○						Selected motor code mismatches with the inverter unit.	Check the motor type, inverter type, and motor code number. (See Par. 14.2.8.)	-	Modify according to the specifications.

Email: service@repairtw.com

Line id: @zzzz

www.repairtw.com

Table 16.2 Cause of Troubles and Action to be Taken

Trouble	Situation of Failure						Failure Cause	Troubleshooting		Remedy
	At Power-ON	Operation Started	Operation Halted	During Acceleration	During Deceleration	With load		Checking Procedure	Result	
The motor does not rotate.							Protective function has been activated.	Check for errors on the digital operator in protective function operation display mode.	Protective function has been activated.	Start troubleshooting according to Table 16.1, "Failure cause and action to be taken."
								Normal	←	
							Control fuse has blown.	Turn OFF power and check if fuse FU3 or FU4 on the power interface card has blown.	Blown.	Replace the fuse (FU3 or FU4).
								Normal	←	
							Disconnection or erroneous connection in the main circuit	Check wiring between the inverter and the motor.	Erroneous wiring	Correct wiring of the main circuit.
								Proper wiring	←	
							Control signal is not functioning.	Check operation status display (V1-09) to see whether the following sequence input signals are input: <ul style="list-style-type: none"> • Operation ready RDY • Emergency stop EMG • Operation FWD or REV Also check operation status display (V1-02) to see whether the speed reference SCOM is input.	Control signals are missing.	Modify the circuit so that control signals are input properly.
								Normal	←	
						Torque limiting	Check if external torque limiting (TLI or TLH) is input.	Torque is limited.	Cancel torque limiting.	
							Torque is not limited.	←		
						Break in wire in motor windings	Check resistance between motor pins. [A circuit tester is necessary.]	Winding resistance is abnormal. (Infinity)	Replace the motor. [Contact your YASKAWA representative]	
							Normal	←		
						Motor failure • The rotor and the stator are in contact with each other. • Bearing is broken.	Turn the motor shaft by hand to see if it moves.	The shaft does not rotate.	Replace the motor. [Contact your YASKAWA representative]	
							The shaft rotates easily.	←		
						Controller failure	Check if the failure can be reproduced.	Reproduced.	Not reproduced.	
							Replace the controller.	Continue operation with care.		

Table 16.2 Cause of Troubles and Action to be Taken (Cont'd)

Trouble	Situation of Failure						Failure Cause	Troubleshooting		Remedy
	At Power-ON	Operation Started	Operation Halted	During Acceleration	During Deceleration	With load		Checking Procedure	Result	
The motor rotates slowly, or only vibrates but does not rotate at all.	○	○					Disconnection or erroneous connection in the main circuit	Check wiring between the inverter and the motor.	Erroneous wiring Proper wiring	Correct wiring of the main circuit.
							Disconnection, erroneous connection, or loose connector in the encoder signal wires	Check wiring of the encoder signal wires.	Erroneous wiring Proper wiring	Correct wiring of the encoder signal wires.
							Motor encoder failure	Check for abnormal changes in motor speed on the speedometer or operation status display (V1-01).	Speed is abnormal. Normal.	Replace the encoder or the motor. [Contact your YASKAWA representative]
							Disconnection or erroneous connection in the speed reference signal wire	Check wiring of the speed reference signal wire.	Erroneous wiring Proper wiring	Correct wiring of the speed reference signal wire.
							Torque limiting	Check if external torque limiting signal (TLL or TLH) is input.	Torque is limited. Torque is not limited.	Cancel torque limiting.
							Controller failure	Check if the failure can be reproduced.	Reproduced. Not reproduced.	Replace the controller. Continue operation with care.
The motor rotates in reverse direction.	○						Erroneous connection in the signal wires in the main circuit motor encoder.	Check wiring according to the connection diagram.	Erroneous wiring	Correct wiring of the signal wires of the main circuit motor encoder.
The motor does not rotate at commanded speed.	○	○					Speed reference signal error	Check speed reference on operation status display (V1-02)	Speed reference value is abnormal. Normal	Readjust speed reference function of the higher system.
							Erroneous setting of motor rated speed	Check control constant C1-26 on the parameter list.	Disagreed with control constant in the list. Agreed.	Correct the control constant
							Motor speed adjustment error	Check motor speed on operation status display (V1-01).	Motor speed disagrees with the commanded value. Normal	Adjust motor speed using control constant C1-12. (See Par.14.4)
							Speed is controlled by P control.	Check operation status display (V1-09) to see if PPI is input	PPI is input. Normal	Modify the circuit to prevent PPI signal from being input.
							Torque limit operation	Check if external torque limiting signal (TLL or TLH) is input.	Torque is limited. Torque is not limited.	Cancel torque limiting.
							Controller failure	Check if the failure can be reproduced.	Reproduced. Not reproduced.	Replace the controller. Continue operation with care.

Table 16.2 Cause of Troubles and Action to be Taken (Cont'd)

Trouble	Situation of Failure						Failure Cause	Troubleshooting		Remedy
	At Power-ON	Operation Started	Operation Halted	During Acceleration	During Deceleration	With load		Checking Procedure	Result	
Extended Accel/ decel Time							Soft starter time setting error (Set time is too long.)	Check control constant C1-10 on the parameter list.	Disagreed with control constant in the list. Agreed. <input checked="" type="checkbox"/>	Correct the control constant.
							Motor code selection error	Check control constant C1-25 on the parameter list.	Disagreed with control constant in the list. Agreed. <input checked="" type="checkbox"/>	Correct the control constant.
		○		○	○		Torque limit operation	Check if external torque limiting signal (TLI or TLH) is input.	Torque is limited Torque is not limited. <input checked="" type="checkbox"/>	Cancel torque limiting
							Excess load on the load machine	Check load status on the load factor meter for loss and inertial momentum of the load machine.	Load is excessive. Normal <input checked="" type="checkbox"/>	Reduce loss and inertial momentum of the load machine. Increase drive capacities of the inverter and the motor.
							Controller failure	Check if the failure can be reproduced.	Reproduced. Not reproduced.	Replace the controller. Continue operation with care.
Motor noise and vibration are high.							Disconnection in the main circuit	Check wiring between the inverter and the motor.	Erroneous wiring Proper wiring <input checked="" type="checkbox"/>	Correct wiring in the main circuit.
							Grounding error of the motor or the inverter	Check continuity of the motor and the inverter to see if they are securely grounded.	Grounding is insufficient. Normal <input checked="" type="checkbox"/>	Use pin E and securely ground the equipment.
		○		○	○		Malfunctioning because of noise (Poor encoder cable characteristics)	Check encoder cable specifications (whether the cable is a twisted pair shielded wire).	Not a twisted pair shielded wire Normal <input checked="" type="checkbox"/>	Replace the encoder cable [Recommended cable: KQVV-SW manufactured by Fujikura Cables.]
							Control constant setting error (especially the speed control proportional gain)	Check control constants on the parameter list.	Disagreed with control constant in the list. Agreed. <input checked="" type="checkbox"/>	Correct the control constants.
							Motor installation error	Check for loose mounting screws.	Loose Normal <input checked="" type="checkbox"/>	Tighten mounting screws.
							Unbalanced motor	Check balance of the rotor.	Not dynamically balanced Normal <input checked="" type="checkbox"/>	Replace the motor. [Contact your YASKAWA representative.]

Table 16.2 Cause of Troubles and Action to be Taken (Cont'd)

Trouble	Situation of Failure						Failure Cause	Troubleshooting		Remedy
	At Power-ON	Operation Started	Operation Halted	During Acceleration	During Deceleration	With load		Checking Procedure	Result	
									<input type="checkbox"/> Out of specifications <input type="checkbox"/> Within specifications	
Motor noise and vibration are high.							Motor failure (•Motor bearing failure •Rotor failure)	Run single motor alone, and check if noise and vibration are within the specifications.	<input type="checkbox"/> Out of specifications <input checked="" type="checkbox"/> Within specifications	Replace the motor. [Contact your YASKAWA representative]
							Positioning or load-machine coupling error	Check coupling and positioning according to Par.11.1.3, "Connection with Load Machine."	<input type="checkbox"/> Coupling or positioning precision was insufficient. <input checked="" type="checkbox"/> Normal	Readjust coupling and perform positioning again.
		○		○		○	Insufficient strength of the load machine	Check for deformation or resonant point on the load machine	<input type="checkbox"/> Deformation or resonant point was found. <input checked="" type="checkbox"/> Normal	Reinforce the load machine.
							Loose foundation bolt.	Check for loose foundation bolt on the load machine.	<input type="checkbox"/> Loose bolt was found. <input checked="" type="checkbox"/> Normal	Tighten the foundation bolts.
							Controller failure	Check if the failure can be reproduced.	<input type="checkbox"/> Reproduced. <input checked="" type="checkbox"/> Not reproduced.	Replace the controller. Continue operation with care.
Motor does not stop.							Control signal does not operate.	Check that operation signal (FWD or REV) is open according to operation status display (V1-09)	<input type="checkbox"/> Operation signal is not open. <input checked="" type="checkbox"/> Normal	Change the reference circuit so that operation signal will be open without fail when the spindle is stopped.
							Controller fault	Verify that the same fault occurs again.	<input type="checkbox"/> Repeatability provided <input checked="" type="checkbox"/> Repeatability not provided	Replace the controller. Continue operation and check the status.
Motor does not stop at orientation.							Orientation signal <u>ORT</u> is not input.	Check that orientation signal <u>ORT</u> is closed according to operation status display (V1-09).	<input type="checkbox"/> Control signal is not input. <input checked="" type="checkbox"/> Normal	Change the circuit so that the control signal will be input normally.
						○	Improper selection signal setting	Verify selection signal setting to compare it to the setting list. • C1-39 bit 0 0:Encoder type 1:Magnetic sensor type • C2-22 bit 6 0:Spindle encoder 1:Motor encoder	<input type="checkbox"/> Does not match with control constant in setting list. <input checked="" type="checkbox"/> Matches.	Change the control constant to a proper value.
							Encoder signal disconnection, improper connector [encoder type]	Check wiring of encoder signal lines.	<input type="checkbox"/> Improper wiring <input checked="" type="checkbox"/> Normal wiring	Correct the encoder signal line wiring.

Table 16.2 Cause of Troubles and Action to be Taken (Cont'd)

Trouble	Situation of Failure						Failure Cause	Troubleshooting		Remedy
	At Power-ON	Operation Started	Operation Halting	During Acceleration	During Deceleration	With load		Checking Procedure	Result	
Motor does not stop at orientation							Encoder fault [encoder type]	Verify that the motor speed changes normally by speedometer indication or operation status display (V1-01)	Speed indicates an abnormal value Normal	Replace the encoder or motor. [Contact your YASKAWA representative.]
							Magnetic sensor signal disconnection, improper connection, removal of connector [magnetic sensor type]	Check the wiring of magnetic sensor signal lines.	Improper wiring Normal wiring	Replace the orientation card or controller.
							Fault of magnetic sensor or magneto [magnetic sensor type]	Rotate the spindle and verify that the ORG signal lights once per rotation by operation status display (V1-01).	Does not light. Lights.	Replace the magnetic sensor or magneto.
							Fault of orientation card or controller	Verify that the same fault occurs again.	Repeatability provided Repeatability not provided	Replace the orientation card or controller. Continue operation and check the status.
Stop position differs from the commanded position (encoder type).							Improper setting of stop position reference	Check whether the position reference is correct by operation status display (V2-04)	Improper position reference Normal	Give a proper stop position reference
							Improper selection of binary/BCD reference or improper setting of BCD reference resolution	Verify the control constant setting and compare it to the setting list. • C2-22 bit 3 • C2-12	Does not match the control constant in the setting list. Matches.	Change the control constant to a proper value.
							Improper selection of reference point at incremental positioning	Verify the control constant setting and compare it to the setting list. • C2-22 bit 5	Does not match the control constant in the setting list. Matches.	Change the control constant to a proper value.
							Improper setting of spindle zero-point position	Perform positioning at zero-point position to measure the position accuracy.	Zero-point position differs. Matches.	Perform adjusting operation again and set the spindle zero-point again.
							Encoder signal line disconnection, improper connection, removal of connector	Check the wiring of encoder signal lines.	Improper wiring Proper wiring	Correct the wiring of the encoder signal lines.
							Malfunction by noise [encoder signal line characteristics fault]	Check the specifications of the encoder cable (if it is twisted pair shielded cable.)	Twisted pair shielded cable is not used. Normal	Replace the encoder cable. [Recommended cable:KQVV-SW made by FUJIKURA DENSEN Co.,Ltd.]
							Controller fault	Verify that the same fault occurs again.	Repeatability provided Repeatability not provided	Replace the controller. Continue operation and check the status.

Table 16.2 Cause of Troubles and Action to be Taken (Cont'd)

Trouble	Situation of Failure						Failure Cause	Troubleshooting		Remedy	
	At Power-ON	Operation Started	Operation Halted	During Acceleration	During Deceleration	With load		Checking Procedure	Result		
Stop position differs from the commanded position (magnetic sensor type)							Magnetic sensor or magnetizer is mounted in the opposite direction.	Check that the sensor or magnetizer is mounted properly, referring to Par. 5.2.5 "Magnetizer and Magnetic Sensor Mounting" and Par. 5.2.4 "Mounting Points".	Mounted in the opposite direction.	Perform tuning operation again.	
							Magnetic sensor signal line disconnection, removal of connector	Check the wiring of the magnetic sensor signal lines.	Improper wiring Proper wiring		Correct the wiring of the magnetic sensor signal lines.
							Orientation card or controller fault	Verify that the same fault occurs again.	Repeatability provided Repeatability not provided		Replace the orientation card or controller.
Orientation completion signal is not output.							Orientation signal ORT is not input.	Check that orientation signal ORT is closed by operation status display (V1-09)	Control signal is not input.	Change the circuit so that the control signal will be input normally.	
							Improper setting of selection signal (Completion signal is not output at tuning of initial setting.)	Check that selection signal (X2-22, C3-22 bit 4) is set correctly. 0:Tuning enabled. 1:Tuning disabled.	Bit 4 is not set to 1 after completion of tuning.	Set the selection signal (C2-22, C3-22) to "1".	
							Improper setting of speed changing ratio	Check that speed changing ratio (C1-27 to 29) are set to proper values by comparing them to the machine specifications.	Machinespecifications do not match the speed changing ratio.	Change and set the speed changing ratio to a proper value.	
							Position control proportional gain is high.	Check that no vibration occurs in the forward and reverse directions near the stop position.	Vibrates. Does not vibrate.	Decrease position control proportional gain unless vibration disappears.	
							Position control proportional gain is low.	Check that the spindle has reached the stop position by operation status display (V2-03 or V3-03).	Stop reference position is not reached.	Decrease position control proportional gain so that position control proportional gain reaches the reference position.	
							Orientation card or controller fault	Verify that the same fault occurs again.	Repeatability provided Repeatability not provided	Replace orientation card or controller. Continue operation and check the status.	

17. SPARE PARTS

Table 17.1 and 17.2 show the number of pieces of the main parts used in a VS-626VM3 controller. At least one set of fuses should be stored.

To order spare parts, contact your YASKAWA representative.

Table 17.1 Part Quantity (200V Class)

	VS-626VM3 (Model CIMR-VM□)								
	3.7k	5.5k	7.5k	11k	15k	18.5k	22k	30k	37k
Controller	ETC62001X								
	1								
Digital Operator	CDR001002								
	1								
Gate Driver	ETC62021X				ETC62022X		ETC62023X		ETC62024X
	1				1		1		1
Power Supply Interface	ETP62001X								ETP62003X
	1								1
Control Power Supply	AVR000379								
	1								
Control Fuse	FU000592								
	2								
Cooling Fan	FAN000130				FAN000111				
	1				1				
Transistor Module	STR 000476	STR 000494	STR 001060	STR 001061	STR 001062	STR 001105	STR 000453	STR 000495	STR 000504
	6	6	6	6	6	6	12	12	12
Electrolytic Capacitor	C 003460		C 006079	C 006075	C 006066	C 006075	C 003402	C 003458	C 003536
	2		2	2	2	4	4	4	4
Magnetic Contactor	MC 003253			MC 003254	MC 003255	MC 003259		MC 003256	MC 003257
	1			1	1	1		1	1
Molded-case Circuit Breaker	MCB 199790	MCB 199720	MCB 199730	MCB 199740	MCB 199750	MCB 199760		MCB 199800	MCB 199840
	1	1	1	1	1	1		1	1

(Upper space: part code No./Lower space: the number of applied pieces)

Table 17.2 Part Quantity (400V Class)

	VS-626V3 (Model CIMR-VM□)						
	7.5k	11k	15k	18.5k	22k	30k	37k
Controller	ETC62001X						
	1						
Digital Operator	CDR001002						
	1						
Gate Driver	ETC62026X		ETC62028X		ETC62027X		
	1		1		1		
Power Supply Interface	ETP62002X						ETP62004X
	1						1
Control Power Supply	AVR000379						
	1						
Control Fuse	FU000592						
	2						
Cooling Fan	FAN000130	FAN000131			FAN000111		
	1	1			2		
Transistor Module	STR 000462	STR 000430	STR 000354	STR 001069	STR 001013	STR 001013	STR 001014
	6	6	6	6	12	12	12
Electrolytic Capacitor	C 003497	C 003402	C 003458	C 003402		C 003458	C 003536
	2	2	2	4		4	4
Magnetic Contactor	MC 005004	MC 003253		MC 003254		MC 003255	MC 003259
	1	1		1		1	1
Molded-case Circuit Breaker	MCB 199790	MCB 199720	MCB 199730	MCB 199740		MCB 199750	MCB 199760
	1	1	1	1		1	1

(Upper space: part code No./Lower space: the number of applied pieces)

Table 17.3 Spare Parts No. for Motor (200V Class)

Standard Type	Model	UAASKA-□*Z								
		04	06	08	11	15	19	22	30*	37†
	Encoder	UTMSI-10AABAZA		UTMSI-10AABAZB	UTMSI-10AABAZC			UTMSI-10AABBZD		
	Cooling Fan†	B835P2152-1	B835P2153-1		B935P3214-1		B935P3218-1		B935P3216-1	B935P3215-1
Winding Selection Type	Model	UAASKB-□*Z								
		06	08	11#	15	19	22			
	Encoder	UTMSI-10AABAZC				UTMSI-10AABBZD				
	Cooling Fan†	B935P3214-1			B935P3216-1		B935P3215-1			

- * Motor model : UAASKJ-30CZ
- † Motor model : UAASKJ-37CZ
- ‡ When ordering the cooling fan, specify the one with housing.
(Because the fan is replaced with housing attached.)
- # Flanged motor model : UAASKD-11CZ1

上正科技有限公司

Table 17.4 Spare Parts No. for Motor (400V Class)

Standard Type	Model	UAASKA-□*Z***E								
		04	06	08	11	15	19	22	30*	37†
	Encoder	UTMSI-10AAFAZA		UTMSI-10AAFAZB	UTMSI-10AAFAZC			UTMSI-10AAFBZD		
	Cooling Fan†	B835P2152-1	B835P2153-1		B935P3214-1		B935P3218-1		B935P3216-1	B935P3215-1
Winding Selection Type	Model	UAASKB-□*Z***E								
		06	08	11#	15	19	22			
	Encoder	UTMSI-10AAFAZC				UTMSI-10AAFBZD				
	Cooling Fan†	B935P3214-1			B935P3216-1		B935P3215-1			

- * Motor model : UAASKJ-30C*Z***E
- † Motor model : UAASKJ-37C*Z***E
- ‡ When ordering the cooling fan, specify the one with housing.
(Because the fan is replaced with housing attached.)
- # Flanged motor model : UAASKD-11CZ1***E

上正科技有限公司
購買、維修 此手冊零組件
電話： 037-466333
Email: service@repairtw.com
Line id: @zzzz
www.repairtw.com

Varispeed-626VM3 DRIVE DESCRIPTIVE MANUAL

TOKYO OFFICE New Pier Takesiba South Tower, 1-16-1, Kaigan, Minatoku, Tokyo 105 Japan
Phone 81-3-5402-4511 Fax 81-3-5402-4580

YASKAWA ELECTRIC AMERICA, INC.

Chicago-Corporate Headquarters 2942 MacArthur Blvd. Northbrook, IL 60062-2028, U.S.A.

Phone 1-847-291-2340 Fax 1-847-498-2430

Chicago-Technical Center 3160 MacArthur Blvd. Northbrook, IL 60062-1917, U.S.A.

Phone 1-847-291-0411 Fax 1-847-291-1018

MOTOMAN INC.

805 Liberty Lane West Carrollton, OH 45449, U.S.A.

Phone 1-513-847-6200 Fax 1-513-847-6277

YASKAWA ELÉTRICO DO BRASIL COMÉRCIO LTDA.

Avenida Brigadeiro Faria Lima 1664-5°CJ 504/511, São Paulo, Brazil

Phone 55-11-815-7723 Fax 55-11-870-3849

YASKAWA ELECTRIC EUROPE GmbH

Am Kronberger Hang 2, 65824 Schwalbach, Germany

Phone 49-6196-569-300 Fax 49-6196-888-301

Motoman Robotics AB

Box 504 S38525 Torsås, Sweden

Phone 46-486-10575 Fax 46-486-41410

Motoman Robotec GmbH

Kammerfeldstraße 1, 85391 Allershausen, Germany

Phone 49-8166-900 Fax 49-8166-9039

YASKAWA ELECTRIC UK LTD.

3 Drum Mains Park Orchardton Woods Cumbernauld, Scotland, G68 9LD U.K.

Phone 44-1236-735000 Fax 44-1236-458182

YASKAWA ELECTRIC KOREA CORPORATION

Paik Nam Bldg. 901 188-3, 1-Ga Euljiro, Joong-Gu Seoul, Korea

Phone 82-2-776-7844 Fax 82-2-753-2639

YASKAWA ELECTRIC (SINGAPORE) PTE. LTD.

151 Lorong Chuan, #04-01, New Tech Park Singapore 556741, Singapore

Phone 65-282-3003 Fax 65-289-3003

YATEC ENGINEERING CORPORATION

Shen Hsiang Tang Sung Chiang Building 10F 146 Sung Chiang Road, Taipei, Taiwan

Phone 886-2-563-0010 Fax 886-2-567-4677

BEIJING OFFICE Room No. 301 Office Building of Beijing International Club, 21 Jianguomenwai Avenue, Beijing 100020, China

Phone 86-10-532-1850 Fax 86-10-532-1851

SHANGHAI OFFICE Room No. 8B Wan Zhong Building 1303 Yan An Road (West), Shanghai 200050, China

Phone 86-21-6212-1015 Fax 86-21-6212-1326

YASKAWA JASON (HK) COMPANY LIMITED

Rm.2916, Hong Kong Plaza, 186-191 Connaught Road West, Hong Kong

Phone 852-2858-3220 Fax 852-2547-5773

TAIPEI OFFICE Shen Hsiang Tang Sung Chiang Building 10F 146 Sung Chiang Road, Taipei, Taiwan

Phone 886-2-563-0010 Fax 886-2-567-4677

www.repairtw.com



YASKAWA

YASKAWA ELECTRIC CORPORATION